



Стенни погълтители

HERADESIGN® Wallcoustic Element

(HERADESIGN® Wall Absorber)











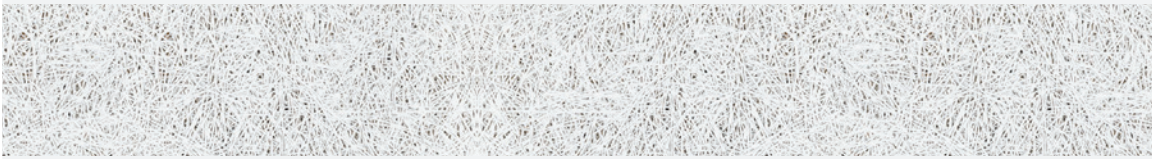



















Индивидуални



- HERADESIGN® Wallcoustic Element е стенно акустично пано от дървесна вата, слепена с магнезит, с 50mm или 100mm акустична вложка.
- Налично в четири различни размера със структура HERADESIGN® Superfine .
- Доставка се като комплект за бърз и лесен монтаж.



Стенни поглътители
HERADESIGN® Wallcoustic Element
 Индивидуални

Структура	HERADESIGN® Superfine											
												
Дебелина на паната (мм)		25										
Размери (мм)		1200 x 600 x 125 (Д x Ш x В): 1200 x 600 x 75 (Д x Ш x В):		Вложка от минерална вата [мм] 100мм 50мм				600 x 600 x 125 (Д x Ш x В): 600 x 600 x 75 (Д x Ш x В):		Вложка от минерална вата [мм] 100мм 50мм		
Система на окачване		Стенният поглътитель се доставя сглобен, готов за монтаж, може да бъде бързо монтиран на подходяща вертикална основа с приложената дървена рамка.										
Тепло		1200 x 600 x 125: 18.3 кг/бр 1200 x 600 x 75: 15.9 кг/бр				600 x 600 x 125: 10.5 кг/бр 600 x 600 x 75: 8.4 кг/бр						
Цветове		Стандартни цветове				Цветове Vario Design						
		 Бял Близък до RAL 9010	 Бежов Естествен цвят 13									
<ul style="list-style-type: none"> • Възможни са и други цветове от популярните RAL и NCS системи за оцветяване. • Отклонения в цвета и външния вид могат да възникнат поради грубата структура на паната. 												
Звукопоглъщане		Вид пано + размери Д x Ш x В [мм]		Дебелина [мм]	HERADESIGN® акустична вложка [мм] [kg/m³]		Еквивалентна абсорбираща площ A _{0b} [m²] Честота [Hz], α _s					
		HERADESIGN® Superfine: 1200 x 600 x 125		25	100	50	125	250	500	1000	2000	4000
		HERADESIGN® Superfine: 1200 x 600 x 75		25	50	50	0.20	0.80	1.10	0.90	1.00	0.90
		HERADESIGN® Superfine: 600 x 600 x 125		25	100	50	0.30	0.70	0.80	0.70	0.60	0.60
		HERADESIGN® Superfine: 600 x 600 x 75		25	50	50	0.10	0.40	0.60	0.50	0.50	0.50
Реакция на огън		Euroclass B-s1,d0 според EN 13501-1										
Влагоустойчивост		Стенният поглътитель не е подходящ за монтаж в закрити плувни басейни или баня.										
Почистване												
Дълговечност	        											

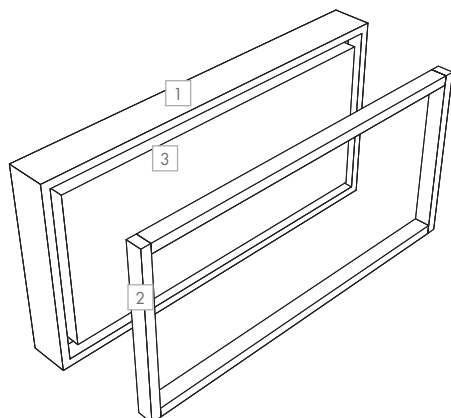

- 1 HERADESIGN® Wallcoustic Element
- 2 Монтажна рамка
- 3 Залепена акустична вложка

[Предидна страница] HERADESIGN® Wallcoustic Element (HERADESIGN® Campus, Австрия, ©Foto Glanzzig)

vb Опциите са тази икона са налични в серия **Vario Design**. Някои комбинации от цветовете не са възможни за всеки продукт. Продуктите варират от страна в страна. Моля свържете се с Вашия местен представител. За повече информация и правна рамка, моля посетете нашата интернет страница.
knaufceilingsolutions.com

09/2022

KNAUFCEILING
 Solutions