

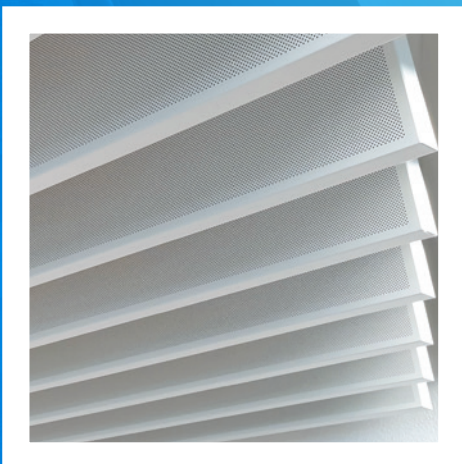













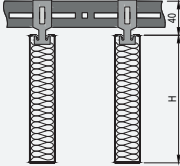

























































































































Системи вертикални бафъли
METAL Baffle Element
(METAL Baffle / V-P 500)
Индивидуални / Групирани



- Системите **METAL Baffle Element** се използват обикновено в помещения с високи акустични изисквания - летища, ж.п.терминали, офиси , търговски и развлекателни центрове и др.
- Линеен монтаж
- Напълно конфигурируемо решение с различни расстояния между бафълите.
- Възможни са комбинации с различни височини и несиметричен монтаж на бафълите.
- Подходящо решение за коридори.
- Бърз и лесен монтаж с регулируеми окачвачи със стоманено въже.
- Монтажът на система U-профил дава прецизна нивелация и възможност за затваряне с капачка от страни.
- Доставят се като комплект от предварително определени типове бафъли в различни дължини.
- Други размери и възможности по запитване.
- Лесно вграждане на инсталационни елементи в тавана.
- Предлагат се допълнителни опции за дизайн, които са част от серия Vario Design



Системи вертикални бафъли
METAL Baffle Element
 Индивидуални / Групирани

<p>Данни за кантовете</p> 	<p>METAL Baffle Element [Индивидуални]</p> 	<p>METAL Baffle Element [Групирани]</p> 																																							
<p>Система</p> 	<p>Комплект за окачване на METAL Baffle (дължина 4000мм) <i>Не е включен.</i> Капачки и свързващи елементи са налични като отделни артикули.</p>	<p>U-профил</p>																																							
<p>Размери (мм)</p> 	<p>1800 x 300 x 30 <i>Опаковка по 26бр/кашон.</i></p>	<p>Дължина на бафъла : различни размери Ширина на бафъла : 30 Височина на бафъла : 150 / 200 / 250 / 300</p>																																							
<p>Материал и перфорации</p> 	<p>Галванизирана стомана с полиестерно крайно покритие, 0,7мм</p> <table border="0"> <tr> <td data-bbox="284 636 496 703">  Неперфорирана </td> <td data-bbox="528 636 740 703">  Стандартна перфорация Rg 2516 <small>Ø: 2.5мм Площ на отворите: 16%</small> </td> <td data-bbox="772 636 984 703">  Микро перфорация Rd 1522 <small>Ø: 1.5мм Площ на отворите: 22%</small> </td> <td data-bbox="1016 636 1228 703">  Екстремно перфорация Rg 0701 <small>Ø: 0.7мм Площ на отворите: 1.5%</small> </td> <td data-bbox="1260 636 1473 703"> <p>(две вертикални страни) Акустична вложка 25мм, 25 кг/м³</p> </td> </tr> <tr> <td colspan="5" data-bbox="284 763 1473 792"> <p>Други перфорации</p> </td> </tr> <tr> <td colspan="5" data-bbox="284 792 1473 869"> <table border="0"> <tr> <td data-bbox="284 792 496 869">  Rd 1511 </td> <td data-bbox="528 792 740 869">  Rg 1511 </td> <td data-bbox="772 792 984 869">  Rg 1821 </td> <td data-bbox="1016 792 1228 869">  Rg 3013 </td> <td data-bbox="1260 792 1473 869">  Qg 4025 </td> </tr> </table> </td> </tr> </table>					 Неперфорирана	 Стандартна перфорация Rg 2516 <small>Ø: 2.5мм Площ на отворите: 16%</small>	 Микро перфорация Rd 1522 <small>Ø: 1.5мм Площ на отворите: 22%</small>	 Екстремно перфорация Rg 0701 <small>Ø: 0.7мм Площ на отворите: 1.5%</small>	<p>(две вертикални страни) Акустична вложка 25мм, 25 кг/м³</p>	<p>Други перфорации</p>					<table border="0"> <tr> <td data-bbox="284 792 496 869">  Rd 1511 </td> <td data-bbox="528 792 740 869">  Rg 1511 </td> <td data-bbox="772 792 984 869">  Rg 1821 </td> <td data-bbox="1016 792 1228 869">  Rg 3013 </td> <td data-bbox="1260 792 1473 869">  Qg 4025 </td> </tr> </table>					 Rd 1511	 Rg 1511	 Rg 1821	 Rg 3013	 Qg 4025																
 Неперфорирана	 Стандартна перфорация Rg 2516 <small>Ø: 2.5мм Площ на отворите: 16%</small>	 Микро перфорация Rd 1522 <small>Ø: 1.5мм Площ на отворите: 22%</small>	 Екстремно перфорация Rg 0701 <small>Ø: 0.7мм Площ на отворите: 1.5%</small>	<p>(две вертикални страни) Акустична вложка 25мм, 25 кг/м³</p>																																					
<p>Други перфорации</p>																																									
<table border="0"> <tr> <td data-bbox="284 792 496 869">  Rd 1511 </td> <td data-bbox="528 792 740 869">  Rg 1511 </td> <td data-bbox="772 792 984 869">  Rg 1821 </td> <td data-bbox="1016 792 1228 869">  Rg 3013 </td> <td data-bbox="1260 792 1473 869">  Qg 4025 </td> </tr> </table>					 Rd 1511	 Rg 1511	 Rg 1821	 Rg 3013	 Qg 4025																																
 Rd 1511	 Rg 1511	 Rg 1821	 Rg 3013	 Qg 4025																																					
<p>Цветове</p> 	<table border="0"> <tr> <td data-bbox="284 958 496 1077" rowspan="2">  RAL 9010 </td> <td colspan="7" data-bbox="528 878 1187 907"> <p>Цветове Vario Design</p> </td> <td colspan="4" data-bbox="1203 878 1528 907"> <p>Дървесен ефект</p> </td> </tr> <tr> <td data-bbox="528 907 592 1048">  Гранит </td> <td data-bbox="608 907 671 1048">  Стомана </td> <td data-bbox="687 907 751 1048">  Зелен мрамор </td> <td data-bbox="767 907 831 1048">  Мед </td> <td data-bbox="847 907 911 1048">  Дъб </td> <td data-bbox="927 907 991 1048">  Месинг </td> <td data-bbox="1007 907 1070 1048">  Пясъчник </td> <td data-bbox="1086 907 1150 1048">  Бетон </td> <td data-bbox="1203 907 1267 1048">  Ясен </td> <td data-bbox="1283 907 1347 1048">  Естествен бамбук </td> <td data-bbox="1362 907 1426 1048">  Бамбук карамел </td> <td data-bbox="1442 907 1506 1048">  Клен </td> </tr> <tr> <td data-bbox="528 1048 592 1160">  RAL 9003 </td> <td data-bbox="608 1048 671 1160">  RAL 9005 </td> <td data-bbox="687 1048 751 1160">  RAL 9006 </td> <td data-bbox="767 1048 831 1160">  RAL 9007 </td> <td data-bbox="847 1048 911 1160">  RAL 9016 </td> <td data-bbox="1203 1048 1267 1160">  Дъб </td> <td data-bbox="1283 1048 1347 1160">  Американска череша </td> <td data-bbox="1362 1048 1426 1160">  Американски орех </td> <td colspan="2"></td> <td colspan="2"></td> </tr> </table>					 RAL 9010	<p>Цветове Vario Design</p>							<p>Дървесен ефект</p>				 Гранит	 Стомана	 Зелен мрамор	 Мед	 Дъб	 Месинг	 Пясъчник	 Бетон	 Ясен	 Естествен бамбук	 Бамбук карамел	 Клен	 RAL 9003	 RAL 9005	 RAL 9006	 RAL 9007	 RAL 9016	 Дъб	 Американска череша	 Американски орех				
 RAL 9010	<p>Цветове Vario Design</p>							<p>Дървесен ефект</p>																																	
	 Гранит	 Стомана	 Зелен мрамор	 Мед	 Дъб	 Месинг	 Пясъчник	 Бетон	 Ясен	 Естествен бамбук	 Бамбук карамел	 Клен																													
 RAL 9003	 RAL 9005	 RAL 9006	 RAL 9007	 RAL 9016	 Дъб	 Американска череша	 Американски орех																																		
<p>Тегло</p> 	<p>Неперфорирана 2.0 - 3.6 kg/lm</p>	<p>Rg 2516 1.7 - 3.1 kg/lm</p>	<p>Rd 1522 1.6 - 2.9 kg/lm</p>	<p>Rg 0701 1.9 - 3.5 kg/lm</p>	<p><i>Теглото зависи от избраните перфорация и дължина.</i></p>																																				
<p>Акустика</p> 	<p>Акустичните свойства зависят от височините на бафълите, разстоянието между тях и височината на окачване. Акустичните стойности са налични при запитване.</p>																																								
<p>Реакция на огън</p> 	<p>Euroclass A2-s1, d0 съгласно EN 13501-1</p>				<p>Стойности валидни само за RAL 9010.</p>																																				
<p>Влагуустойчивост</p> 	<p>90% RH</p>																																								
<p>Качество на въздуха</p> 	<table border="0"> <tr> <td data-bbox="284 1411 347 1496">  A </td> <td data-bbox="363 1411 427 1496">  E1 </td> <td colspan="3"></td> </tr> </table>					 A	 E1																																		
 A	 E1																																								
<p>Почистване</p> 	 <p>(само неперфорирани)</p>																																								
<p>Дълговечност</p> 	<table border="0"> <tr> <td data-bbox="284 1588 347 1673">  EN ISO 14021 =14% </td> <td data-bbox="363 1588 427 1673">  EPD EN ISO 14025 </td> <td data-bbox="443 1588 507 1673">  ISO 9001 </td> <td colspan="2"></td> </tr> </table>					 EN ISO 14021 =14%	 EPD EN ISO 14025	 ISO 9001																																	
 EN ISO 14021 =14%	 EPD EN ISO 14025	 ISO 9001																																							

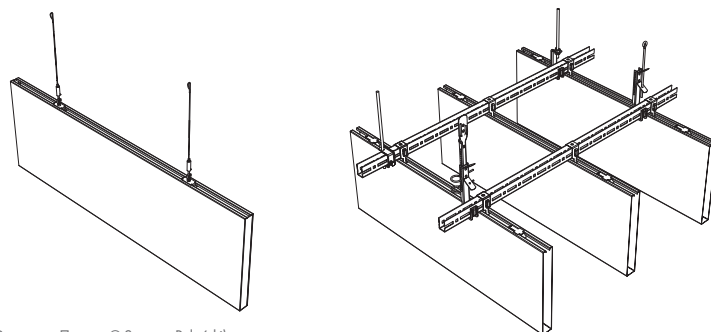

[Предишна страница] METAL Baffle Element, групирани (E&Y, Варшава, Полша, © Szymon Polański)

vo Опциите с тази икона са налични в серия **Vario Design**. Някои комбинации от цветове и/или перфорации не са налични за всеки продукт. Продуктите могат да варират в различните страни. Моля свържете се с Вашия регионален представител. Допълнителна информация и правна рамка можете да намерите на нашия уебсайт. knaufceilingsolutions.com