

# MINERAL SOLUTIONS

**KNAUF**CEILING  
*Solutions*





# Experience More Innovation

## WITH FUNCTIONAL, NATURAL AND SUSTAINABLE MINERAL SOLUTIONS

We believe that the ceiling is an integral part of every interior space. It helps give us a wonderful sense of well-being and safety. A seamless connection between form and function, it enhances and protects the spaces in which we live, work, recover and grow. It balances acoustics, provides healthy air to breathe and influences how we think and feel.

Ultimately, it is our customers who create the perfect space using our solutions. To help them realise more exciting visions, two of the world's most recognised ceiling manufacturers, Armstrong Ceiling Solutions and Knauf AMF have combined strengths to offer the best of both in one market-leading brand – Knauf Ceiling Solutions.

Spectacular projects can only become reality if the possibilities between functionality and design live in harmony. Our new harmonised Mineral Solutions range enables customers endless varieties of sizes, shapes and edge designs in all system layouts.

The high-quality mineral tiles are produced in a wet-felt tile process that uses natural, sustainable raw materials, including biosoluble mineral wool, perlite, clay and starch.

By embodying the best of both worlds and building on our long-standing experience, Knauf Ceiling Solutions is setting the standard for safety, comfort, efficiency and performance. With a boundless multi-material approach that enables you to experience more choice, more inspiration and more support, to help find the unique solution you're looking for.

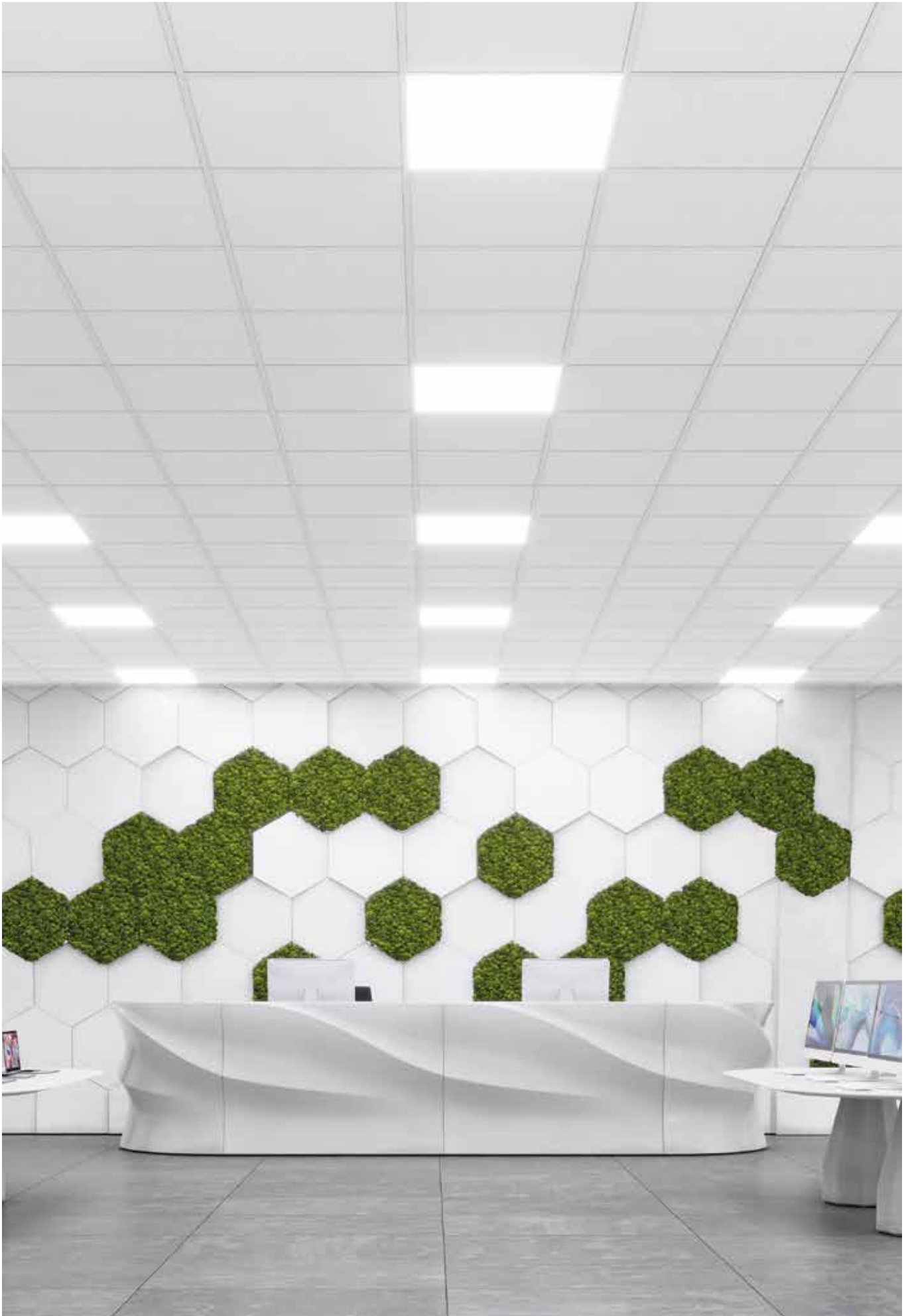



# Production Network

## EXPERIENCE OUR LARGE AND COMPREHENSIVE NETWORK

Through the local presence of thirteen state-of-the-art production facilities in eight countries across Europe and Asia, we are able to deliver high-quality ceiling solutions on time. In order to provide our customers consistent and reliable supply processes, we rely on our proven production values that meet the highest standards worldwide in quality, environment and safety.





09

10

11



## EMEA

- 01 Grafenau (DE)**  
Mineral & Grid
- 02 Stafford (UK)**  
Metal
- 03 Pontarlier (FR)**  
Mineral
- 04 Valenciennes (FR)**  
Grid
- 05 Dreux (FR)**  
Grid
- 06 Ferndorf (AT)**  
Wood Wool
- 07 Rankweil (AT)**  
Metal
- 08 Antwerp (BE)**  
Slitting



## APAC

- 09 Wujiang (CN)**  
Mineral
- 10 Shanghai (CN)**  
Grid
- 11 Pune (IN)**  
Grid

# DEFINITION OF TECHNICAL PERFORMANCE ICONS



## SOUND ABSORPTION

A single-number rating for random incidence sound absorption coefficients as calculated by reference to EN ISO 11654 ( $\alpha_w$ ) or to ASTM C 423 (NRC).



## SOUND ABSORPTION CLASS

A classification for sound absorption (A – E) based upon the sound absorption  $\alpha_w$  value.



## SOUND REDUCTION

A single-number rating for airborne sound transmission (single pass) as calculated by reference to EN ISO 717-1.



## SOUND ATTENUATION

A single-number rating for flanking sound transmission between adjacent rooms, as calculated by reference to EN ISO 717-1 ( $D_{nfw}$ ) and/or ASTM E413-10 (CAC).



## FIRE REACTION

Reaction to fire classification in accordance with EN 13501-1 expressed as Euroclass (A1 – F). Additionally in accordance with ASTM E84, expressed as Class A and 123-FZ, expressed as KM0 – KM2.



## HUMIDITY RESISTANCE

Maximum relative humidity conditions for installation and lifetime of ceiling.



## LIGHT REFLECTANCE

Light reflection is the proportion of incident light that is reflected back off the product, when tested in accordance with EN ISO 7724-2 and 3.



## LIGHT DIFFUSION

The percentage of reflected light which is diffused.



## INDOOR AIR QUALITY

The Eurofins Indoor Air Comfort (Gold) certification ensures that all product-related health criteria on product emissions are sufficiently fulfilled. It is a sign confirming the quality claim of the manufacturer and its contribution to a healthy indoor climate. Mainly VOCs emissions can pose a serious risk, especially to children. Limiting VOC from indoor building products is the subject of many national regulations and voluntary quality labels. A lot of these regulations are covered by IAC(G).



## AIR PERMEABILITY

Tested in accordance with DIN 18177, the air permeability rating indicates the cubic metres of air leakage per hour per square metre.



## RECYCLED CONTENT

The recycled content of the product, as calculated in accordance with ISO 14021:2016.



## CERTIFIED CRADLE TO CRADLE

Products with this icon are C2C certified, providing a transparent mechanism to compare the sustainability performance of products, showing that they are designed for recycling and can help protect and sustain our environment for future generations by keeping resources in the economy for longer.



## ENVIRONMENTAL PRODUCT DECLARATION (EPD)

are independently verified and registered documents that communicate transparent and comparable information about the life-cycle environmental impact of products. Knauf Ceiling Solutions EPDs have been third party certified by IBU (Institut Bauen und Umwelt e.V. (IBU) as conforming to the requirements of ISO 14025.



## M1 CLASSIFICATION

The Finnish emission label for building products is one of the leading test labels in the Scandinavian region. M1 is the best category and stands for "low emission". The M1 classification sets requirements for the emission of VOC, formaldehyde, ammonia and other substances.



## VOC

The VOC emission performance in accordance with the French labelling requirements.



## FORMALDEHYDE (E1)

Formaldehyde emission level (E1 = lowest test result possible).



## BLUE ANGEL

The Blue Angel ecolabel is awarded by an independent Jury to environmentally friendly products. Each label specifies that the product meets a list of criteria considering environmental and health-related aspects.

[www.blauer-engel.de/uz132](http://www.blauer-engel.de/uz132)



## ISO 9001

This icon demonstrates Knauf Ceiling Solutions ability to consistently provide products and services that meet customer and regulatory quality management system requirements.



## THERMAL CONDUCTIVITY

Tested in accordance with EN 12667, the thermal conductivity rating measures the rate of heat flow through a material.



## EDGE DETAILS

Indicates the different edge details available for the ceiling tile of reference.



## THICKNESS

Indicates the thickness for the ceiling tile of reference.



## DIMENSIONS

Indicates the sizes available for the ceiling tile of reference.



## SYSTEMS

Indicates the suspension systems compatible with the ceiling tile of reference.



## WEIGHT

Weight per unit area of the product (kg/m<sup>2</sup>).



## COLOURS

Custom colours available for products with this icon.



## ANTIMICROBIAL

Antimicrobial finish on standard mineral tiles and available as a custom option on metal products with this icon.



## SCRATCH RESISTANCE

Products with this icon offer a superior level of surface scratch resistance, evaluated with the Hess Rake test.



## PRODUCT HANDLING & DURABILITY

Solutions with enhanced durability for improved handling and resistance to damage.

## CLEANING AND DISINFECTION

The frequency and cleaning method of a ceiling varies from one application to another. All products can at least be cleaned with a dry cloth or vacuum cleaner.



For standard cleaning of dust, loose dirt or deposits, a soft brush, a clean, dry, soft white cloth, a normal vacuum cleaner with a soft brush or focus compressed air can be used.



For more intensive cleaning, the surfaces can be damp cleaned. This should be carried out with a wrung-out soft cloth or sponge. After cleaning, the surfaces of the tile should be dried with a soft cloth.



Wet cleaning should be carried out with lukewarm water (up to 40°C), using a sponge and mild cleaning agent (with a pH value between 7 and 9), and using medium pressure. After cleaning, the surface should be dried with a soft cloth.



Can be cleaned using a high pressure water spray. After cleaning, the surface should be dried.



Can be cleaned using focus compressed air. The apparatus used should be a cleaner that generates steam under pressure (8 bar and 175°C).



Can be cleaned with specific disinfectants commonly used in healthcare premises. Disinfectants should be used as a spray on wipes.

For detailed information please ask us for the cleaning instructions. **7**

## CE MARKING

In Europe, the Construction Products Regulations (305/2011/EU) defines essential requirements for products (and projects) such that they are safe and fit for their intended use. Harmonized Product Standards respond to these essential requirements and set out what tests must be conducted and how the performance must be communicated. For suspended ceilings the applicable product standard is EN 13964 Suspended Ceilings – Requirements & Test Methods.

The essential requirements identified for suspended ceiling membranes (tiles & baffles) include:

- Reaction to Fire (mandatory)
- Formaldehyde Emissions (mandatory)
- Sound Absorption
- Flexural Tensile Strength / Durability
- Thermal conductivity

It is mandatory to CE Mark products within the scope of EN 13964 and provide a Declaration of Performance in order to place the product on the market.

All Knauf Ceiling Solutions Declarations of Performance can be found on Knauf Ceiling Solutions website.

# ACOUSTIC TECHNICAL GLOSSARY

## WEIGHTED SOUND ABSORPTION COEFFICIENT, $\alpha_w$

A single-number rating for random incidence sound absorption coefficients calculated by reference to EN ISO 11654. With this method measured values obtained in accordance with EN ISO 354, are converted into octave bands at 250, 500, 1000, 2000 and 4000 Hz and are plotted onto a graph. A standard reference curve is then shifted towards the measured values in steps of 0.05 until a "best fit" is obtained. The derived value of  $\alpha_w$  will vary between 0.00 and 1.00 but is only expressed in multiples of 0.05, e.g.  $\alpha_w = 0.65$ .

## SHAPE INDICATOR

With reference to EN ISO 11654, the calculated value of  $w$  may be qualified by one or max. two (in brackets) to indicate if the product has excess sound absorption at low (L), medium (M) or high (H) frequencies.

## SOUND ABSORPTION CLASS

With reference to EN ISO 11654, the calculated value of  $w$  may additionally be allocated into one of six descriptive classes in accordance with the following table:

Sound Absorption Class	$\alpha_w$
A	0.90; 0.95; 1.00
B	0.80; 0.85
C	0.60; 0.65; 0.70; 0.75
D	0.30; 0.35; 0.40; 0.45; 0.50; 0.55
E	0.15; 0.20; 0.25
Not Classified	0.00; 0.05; 0.10

## WEIGHTED SUSPENDED CEILING NORMALISED LEVEL DIFFERENCE, $D_{ncw}$

A single-number rating of the laboratory measurement of room-to-room (horizontal) airborne sound insulation of a suspended ceiling above adjacent rooms sharing a common ceiling plenum. It is determined in accordance with EN ISO 717-1 from measurements made in accordance with EN 20140-9. Note: EN 20149-9 has now been withdrawn and superseded by EN ISO 10848-2 (see  $D_{nfw}$ ), although  $D_{ncw}$  test results still continue to be valid.

## WEIGHTED SUSPENDED CEILING NORMALISED FLANKING LEVEL DIFFERENCE, $D_{nfw}$

A single-number rating of the laboratory measurement of room-to-room (horizontal) airborne flanking sound transmission of a suspended ceiling above adjacent rooms sharing a common ceiling plenum. It is determined in accordance with EN ISO 717-1 from measurements made in accordance with EN ISO 10848-2. This has now superseded EN 20149- 9. (see  $D_{ncw}$ ).

## WEIGHTED SOUND REDUCTION INDEX, $R_w$

A single-number rating of the laboratory measurement of (vertical) airborne sound reduction of a suspended ceiling. It is determined by reference to EN ISO 717-1 from measurements of sound reduction index made in accordance with EN ISO 140-3.

## **RAIN NOISE SOUND INTENSITY LEVEL, $L_r$**

The laboratory measurement of the sound intensity in a room below a roof construction when subjected to rainfall. It is determined by reference to EN ISO 140-18:2006 – Laboratory measurement of sound generated by rainfall on building elements. The roof's performance can be tested with or without a suspended ceiling beneath. The intensity of the rainfall tested can be selected from the options given in the standard. A combined A-weighted single-number (LIA) can also be determined. Unlike  $D_{ntw}$  and  $R_w$  data, where the higher the value the better the insulation provided, the lower the intensity value (weighted LIA) the better the insulation performance of the ceiling and roof combination.

## **EQUIVALENT ABSORPTION AREA (EAA)**

The equivalent absorption is a measure of the total sound absorption by discrete objects (canopies, screens, furniture etc) when installed in an architectural space. Because these types of absorbers have more than one surface and may be irregular in form, it is not meaningful to assign sound absorption coefficients to them. Hence the Equivalent Absorption Area per unit (measured in Sabines) is preferred to characterise the absorption provided by an individual 'space absorber'.

## **SOUND REDUCTION**

A term used in relation to the vertical transmission of sound through a suspended ceiling.

## **SOUND ATTENUATION**

A term used in relation to the horizontal transmission of sound through a suspended ceiling above adjacent rooms sharing a common ceiling plenum.

## **NOISE REDUCTION COEFFICIENT, NRC**

A single-number descriptor of random incidence sound absorption coefficients. Defined in ASTM C423 as the arithmetical average, to the nearest multiple of 0.05, of the measured sound absorption coefficients for the four one-third octave band centre frequencies of 250, 500, 1,000 and 2,000 Hz.

# ACOUSTICAL SOLUTIONS FOR EVERY SPACE

## Meet all expectations of acoustical comfort with Knauf Ceiling Solutions

Knauf Ceiling Solutions provide three densities of ceiling tiles to achieve high absorption, high attenuation or a good balance between the two of to meet all requirements in every space.

### BALANCED ACOUSTICS

Standard range provides a unique combination of good sound absorption and sound attenuation that enhance intelligibility for workplace effectiveness.

Speech intelligibility addresses the need for comprehension of verbal communication whether naturally spoken or broadcast by an amplified system, within a given space.

Intelligibility can be expressed as the difference in decibels between the level of speech and the background noise (signal to noise ratio) as heard at the listener's position.

To ensure excellent intelligibility, this difference at the listeners position is recommended to be 10-15 dB minimum for people with good hearing and 20-30 dB for hearing impairing of users of headsets.

### HIGH ATTENUATION

Our dB range offers excellent sound attenuation and good sound absorption that enhances privacy and confidentiality.

Speech privacy is a measure for defining the degree to which conversation cannot be overheard.

For good privacy between adjacent spaces, it's necessary to focus on room-to-room sound attenuation and the background noise level.

### HIGH ABSORPTION

Products with high absorption levels are recommended when concentration is needed. They dramatically improve the acoustic comfort in open spaces, call centres, etc.

Concentration can be disturbed by different types of noise, such as other peoples' voices, phones ringing, ventilation, keyboard, equipment, impacts, road and air traffic...

Intrusive noise will disturb concentration and therefore needs to be considered as another key factor in the design of the acoustical environment.



## STRUCTURAL FIRE PROTECTION

Throughout Europe, there is a requirement for a building's structure to be protected from fire. This is primarily for the structure to remain stable during a fire to allow the occupants to escape and also to enable fire fighters to work without threat of the building's collapse. The duration of the required protection will usually depend upon the height of, and location within, the building (i.e. typical floor, basement, roof construction etc), whether there is any active methods of fire protection (sprinklers etc.) and the type of construction to be protected (steel beams, timber or mezzanine floors etc). In the case of structural fire protection, the suspended ceiling is classified together with the soffit and the complete construction.

Knauf Ceiling Solutions ceilings achieve building component classifications of REI30 to REI120, depending on the type of soffit. Regular fire testing is carried out to ensure the highest up to date system quality and built in safety for our customers.

## INDEPENDENT FIRE RESISTANCE

Independent fire rated ceilings provide fire protection both from above (ceiling void) as well as from the underside of the ceiling. Fittings, such as lighting, loudspeakers and signage etc. as well as the connection to light-weight partition systems, bulkheads etc. are tested and classified as well.

In case of a fire in the ceiling void (incidentally, the most common fire source) the underlying escape routes are protected by AMF THERMATEX® Uno fire rated ceiling for 30 minutes.

*Fire resistant certificates such as the German abP- certificates are available on request.*

## BUILDING REGULATIONS

Fire reaction performance for suspended ceilings is shown using the Euroclass fire reaction classification. Most Knauf Ceiling Solutions products are reaching A2-s1,d0 acc. to EN 13501-1.

*For more information, please contact us or visit [www.knaufceilingsolutions.com](http://www.knaufceilingsolutions.com)*

# HEALTHY INTERIORS

## CHALLENGE

The World Health Organization reports that 30% of new and renovated buildings receive excessive complaints related to indoor air quality.

In addition, poor air quality, and elevated temperatures consistently lowered employee performance by up to 10%.

## SOLUTION

Knauf Ceiling Solutions:

- achieve low or very low VOC and formaldehyde emission levels.
- have all been classified E1 for formaldehyde (best test result possible).
- for a large majority, achieve A+ (the best performance level under the stringent French VOC labelling system).

## In certain indoor spaces such as laboratories

It is essential to limit the number of airborne particles by creating a Clean Room-type environment using products certified in accordance with ISO 14644-1.

Knauf Ceiling Solutions offers solutions for areas requiring minimal to the most stringent requirements.



Achieving the right acoustics for specific rooms is recognised in LEED®, BREEAM, HQE, DGNB, WELL Building Standard.

## CHALLENGE

The light reflectance of the ceiling, floor and wall surfaces play the second most important role for overall illumination of the room, directly affecting working comfort, wellbeing and productivity.

## SOLUTION

Specifying high light reflectance ceilings contribute to LEED®, BREEAM, HQE, DGNB and Well Building Standard credits.

A well-design ceiling with high light reflectance:

- Improves space illumination, allowing for fewer light fixtures
- Reduces electrical light output and lowers maintenance costs
- Reduces cooling load

High light reflectance ceilings up to 87% of the light back into the space.

Rafts and canopy ceilings installed over a working place improve the light reflection for better comfort for the end-user.



## Cradle to Cradle Certified®

The Cradle to Cradle Certified® product programme has been developed to meet growing customer demand for sustainable products, with C2C certification already becoming a requirement for building projects in the United States and Europe. It adds value to a project and helps protect and sustain our environment for future generations by keeping resources in the economy for longer. Cradle to Cradle Certified® products are recognised in LEED® and WELL Building Standard credits.



**IMI**

Integrated Micro-Electronics  
Niš



## WORKPLACES THAT WORK BETTER

**Over our lifetimes, the average person spends around 90,000 hours in the workplace. It's our responsibility to make these spaces better for everyone.**

This isn't just about happiness — even if happier workers are better workers. It's about wellbeing in the workplace. Wellbeing boosts productivity. It improves performance, reduces stress and contributes to a work-life balance that brings out the best in people. And one of the ways we can promote wellbeing in the workplace is through design.

By considering aesthetics, light, shade and zoning, intelligent design can transform even the most uniform open-plan office into a vibrant, dynamic space that balances contemporary architecture and statement design with visual, and acoustic comfort that measurably enhances wellbeing and happiness, productivity and performance.

Even beyond these considerations, the principles we use in enabling great office design can create more functionally effective spaces for working. Spaces for close collaboration and quiet concentration; spaces that keep conversations private, or open the floor to discussion and debate — and spaces that aid focus while inspiring workers and visitors alike. This is our task, our responsibility and our opportunity, together, to create workspaces that work better.





## CREATE SPACES TO INSPIRE

**Having an education that will last a lifetime is down to outstanding, inspirational teachers that deliver learning with knowledge and passion — but these tutors need the right spaces in which to do this.**

Schools, colleges and universities are complex ecosystems, and the buildings that house them need to take this into account. They encompass everything from focussed classrooms, quiet study areas to sweeping auditoria and lecture theatres, sound studios and common rooms. Each space has its own requirements and intricacies — but all need to optimise the learning experience.

So, what does this take? It takes careful consideration of architectural zoning, and how each space works individually and as part of the ecosystem. It takes a balance of acoustic performance and visual comfort — where tutors can be heard clearly at the back of the class, and where students can concentrate on their work.

Above all, however, it takes an awareness, sensitivity and commitment to creating a safe, healthy and peaceful environment for education to thrive, and a dedication to creating spaces as inspiring as the teaching within them.



## SHAPING THE RETAIL EXPERIENCE

**The path to purchase is never straightforward. There's a world of factors along the way that can sway a decision. And a major one of these is the retail environment — and the experience it creates.**

Whether it's a supermarket or convenience store, shopping mall or showroom, food court or fashion boutique, the design of a retail space is integral to the shopper experience — and we should treat this experience like any other we'd desire to have. It should be comfortable and easily navigable, but it should also surprise, excite, entertain and entice.

The materials, technologies and techniques we use to create our retail environments are vital for making this happen. Visually arresting design features; playful manipulation of light and shade, colour and shape; bright, open and airy room plans; intuitive pathways, and acoustically comfortable, unintimidating spaces to encourage customer interaction and streamline the sales process. All of these play their part in a positive shopper experience.

By blending functionality with flair, great design doesn't just breathe fresh life into brands in the real world — it shapes a retail experience that people will enjoy, share and remember.





NO SMOKING

MS Antares



FRAGILE

KASSE

3901

3801

3814

## MAKE YOURSELF AT HOME

**Rest and relaxation is crucial for everyone's way of life — especially as everyone's way of life is different. But whatever people get up to in their downtime, their leisure spaces should be as enriching as their pastimes.**

Sometimes, it's all about high-tempo sports or hitting the gym. Other times, it's dining out, heading away for a hotel stay, or simply taking in a film at the cinema. There's a huge variety of spaces in which we spend our free time, but all of them share one requirement for design and architecture: creating the right atmosphere to enhance quality of life.

This might take the form of maintaining the right acoustical balance to focus viewers on the movie. It might be flooding fitness studios with light while keeping an effective thermal performance and maximising humidity resistance. Or, it might be designing a hotel as part of a multi-use building in which statement design atria and lobbies give way to cosy, comfortable guest rooms.

For every architectural challenge in leisure and hospitality spaces, there's an idea to help you achieve it — a solution to make your work easier and more effective. Because, let's face it, everyone deserves a little relaxation.







## CREATING SPACES FOR HEALING

**Healthcare places huge demands on architecture — no matter if it's a waiting room in a local surgery or the intense environment of the operating theatre. In every space, there's a host of considerations critical to lives.**

The most vital element is, of course, creating a space that's conducive to healthcare — hygienically clean, performing at the anti-microbial level, using materials and technologies that enhance indoor air quality and minimise emissions, and safeguarding patients and caregivers alike through robust fire protection.

Going beyond this, it's our responsibility to design environments that actively aid the healing process. Given the proven importance of natural light to wellbeing, it's imperative that our healthcare spaces are bright and open, with high levels of light reflectance that makes the most of window space. Acoustically, too, these spaces need to absorb and attenuate noise, providing the peace, quiet and tranquillity for people to rest and recover

Ultimately, healthcare environments need to be perfectly attuned to their purpose, functionally and aesthetically. Clean and simple, bright and welcoming, calm and comfortable. Everything it takes for doctors to perform and patients to recover — and all the ingredients to create the perfect spaces for healing.

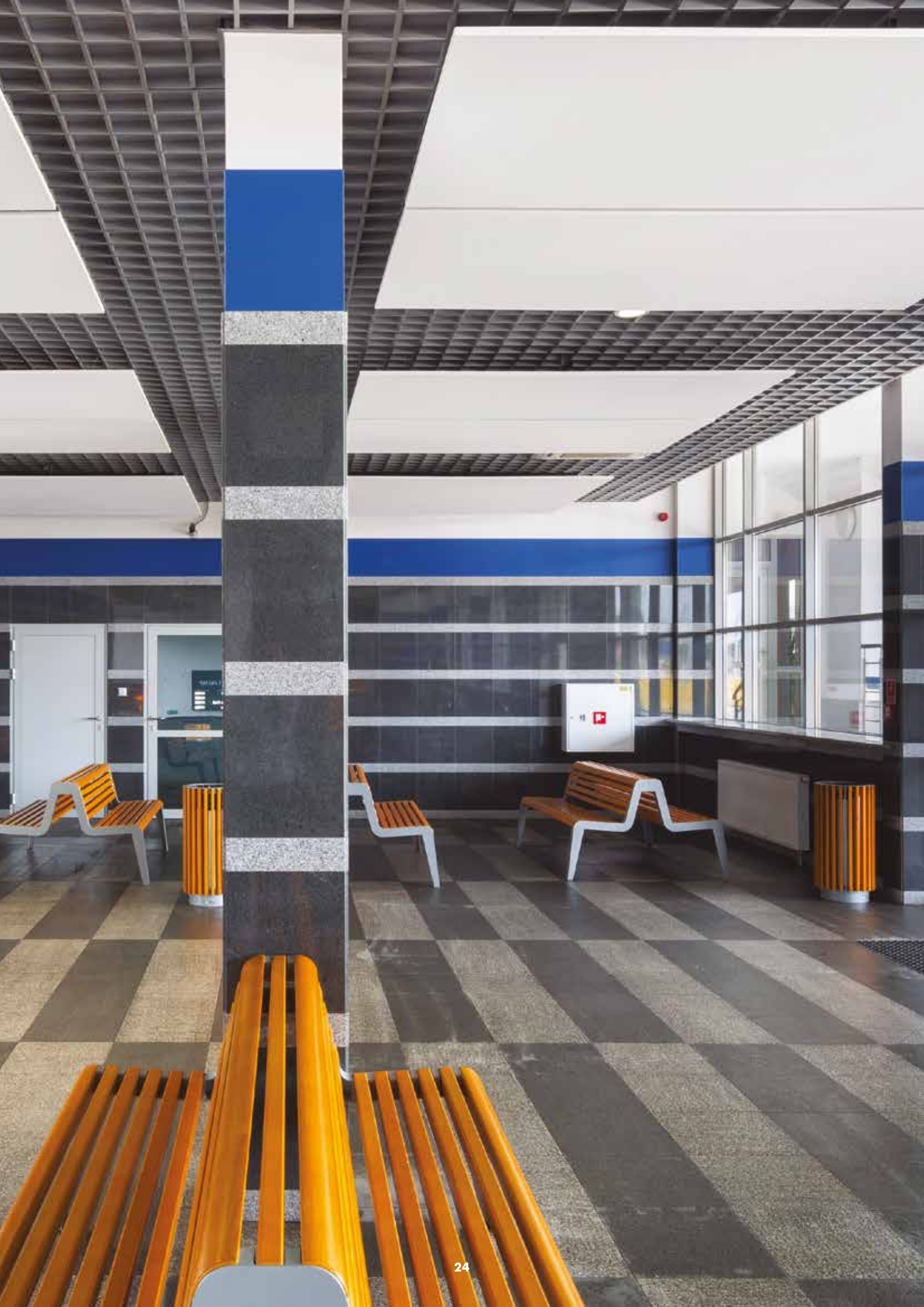

## ARCHITECTURE THAT MOVES PEOPLE

**Our world is always in motion  
— billions of people travelling from  
city to city, continent to continent.  
And the buildings in which they  
arrive and depart need to play their  
part in making every journey better.**

From airport departure lounges to train station concourses, from the food court through to the platform, the architecture of transportation is a journey. Ceilings, walls and floors are travellers' companions; the first and last things they'll see in any location, the backdrops to meetings and partings — and a crucial part of people's journeys.

So, we should approach these buildings rationally and emotionally. They need to be functional, to guide travellers to gates, lounges and platforms. They need to be clean, maintainable and durable to cope with the footfall of millions every day. But they also need to be calming and welcoming; tranquil, peaceful places that encourage exploration.

To this end, we need to transform the dark tunnels and cavernous lobbies that once characterised transport hubs into bright, open and desirable spaces, concealing the noise and passage of crowds to make people feel comfortable. And all of this while using design to make an impression – to create spaces that move people, physically and emotionally.

# OVERVIEW

## DESIGN

MINERAL Baffle Element	30	MINERAL Wallcoustic Element	42
MINERAL Baffle Element Arc	32	MINERAL Wallcoustic Line	44
MINERAL Baffle Line L / N	34	FABRIC Wallcoustic Line	46
MINERAL Sonic Element	36	AMF THERMATEX® Alpha Colour	48
MINERAL Sonic Line Arc	38	Focus: AMF THERMATEX® Varioline	50
MINERAL Sonic Line	40		

## SMOOTH WHITE ACOUSTIC

AMF THERMATEX® Acoustic	54	Armstrong PERLA OP 0.95	72
AMF THERMATEX® dB Acoustic	56	Armstrong PERLA OP 19mm	74
AMF THERMATEX® Alpha HD 19mm	58	Armstrong PERLA OP 1.00	76
AMF THERMATEX® Alpha HD 30mm	60	Antaris	78
AMF THERMATEX® Alpha HD 35mm	62	Antaris C	80
AMF THERMATEX® Alpha One	64	AMF THERMATEX® Thermofon	82
AMF THERMATEX® Alpha	66	AMF TOPIQ® Prime	84
Armstrong PERLA	68	AMF TOPIQ® Efficient Pro	86
Armstrong PERLA dB	70		

## HEALTHCARE & HYGIENE

Armstrong BIOGUARD Acoustic OP	90	AMF THERMATEX® Aquatec	98
Armstrong BIOGUARD Acoustic	92	AMF THERMATEX® Thermaclean	100
Armstrong BIOGUARD Plain 15mm	94	AMF TOPIQ® Efficient Pro Hygena	102
Armstrong SANIGUARD	96	Armstrong NEWTONE	104

## CLASSIC PLAIN

PLAIN	108	Armstrong RETAIL	110
-------	-----	------------------	-----

## CLASSIC SANDED

Armstrong SAHARA	114	AMF ECOMIN Orbit	120
AMF THERMATEX® Feinstratos	116	Armstrong FERIA	122
AMF THERMATEX® Feinstratos Micro	118	Armstrong SAVANNA	124

## CLASSIC FISSURED/PERFORATED

Star 15mm	128	AMF THERMATEX® Feinfresko	136
AMF THERMATEX® Mercure	130	AMF ECOMIN Filigran	138
Armstrong FINE FISSURED	132	AMF ECOMIN Planet	140
Armstrong CORTEGA	134		

## FIRE PROTECTION

AMF THERMATEX® Uno	144		
--------------------	-----	--	--







# Design

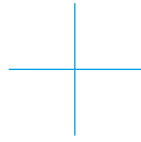

IN A WORLD WHERE IMAGE IS EVERYTHING, OUR FLEXIBLE CEILING SOLUTIONS INSPIRE YOU TO CREATE STUNNING AESTHETICS AND INTIMATE SPACES.

An endless array of dramatic design possibilities with baffles, canopies, wall absorbers and accessories that can be easily installed and relocated without further modification. Exposed surfaces that absorb sound to enhance acoustics, while reflecting up to 87% of light to make brighter, energy efficient spaces. And seamless, monolithic floating ceilings that add colour, shape, depth, scale and rhythm to contemporary building design.





Vertical Baffle Systems

## MINERAL Baffle Element

Individual / Grouped













































- MINERAL Baffle Element is a range of high performance acoustical baffles with a white laminate surface for a modern linear appearance.
- Good sound absorption: reduce noise levels, increase intelligibility and reduce reverberation time in a space
- Typically used to provide high levels of acoustic absorption in offices, leisure centres, transport hubs, etc



# MINERAL Baffle Element

Individual / Grouped

<b>Thickness (mm)</b>		39																						
<b>Dimensions (mm)</b> Additional dimensions available on request		1200 x 300 1200 x 400	1800 x 300 1800 x 400																					
<b>System</b>		Hanging Wire Kit U Profile grouping option T Grid grouping option																						
<b>Weight</b>		1200 x 300: 3.8 kg / pc 1200 x 400: 5.0 kg / pc	1800 x 300: 5.6 kg / pc 1800 x 400: 7.5 kg / pc																					
<b>Colour &amp; design</b>		<div style="border: 1px solid #ccc; padding: 5px;"> <p><b>VD Vario Design Colours</b></p> <table border="0"> <tr> <td></td> <td></td> <td></td> <td></td> <td></td> <td></td> <td></td> <td></td> <td></td> </tr> <tr> <td>White</td> <td>Granite</td> <td>Steel</td> <td>Green Marble</td> <td>Copper</td> <td>Oak</td> <td>Brass</td> <td>Sandstone</td> <td>Concrete</td> </tr> </table> </div>											White	Granite	Steel	Green Marble	Copper	Oak	Brass	Sandstone	Concrete			
																								
White	Granite	Steel	Green Marble	Copper	Oak	Brass	Sandstone	Concrete																
<b>Sound absorption</b>		<p>EN ISO 354</p> <p><math>\alpha_w = 0.50(MH)</math> (300mm) as per EN ISO 11654 - <b>Class D</b></p> <table border="1"> <thead> <tr> <th>Frequency f (Hz)</th> <th>125</th> <th>250</th> <th>500</th> <th>1000</th> <th>2000</th> <th>4000</th> </tr> </thead> <tbody> <tr> <td>Baffles 1200 x 300mm</td> <td></td> <td></td> <td></td> <td></td> <td></td> <td></td> </tr> <tr> <td><math>\alpha_p</math> Row distances 300mm</td> <td>0.15</td> <td>0.25</td> <td>0.45</td> <td>0.90</td> <td>0.90</td> <td>0.95</td> </tr> </tbody> </table> <p>NRC = <b>0.65</b> (300mm) as per ASTM C 423</p>		Frequency f (Hz)	125	250	500	1000	2000	4000	Baffles 1200 x 300mm							$\alpha_p$ Row distances 300mm	0.15	0.25	0.45	0.90	0.90	0.95
Frequency f (Hz)	125	250	500	1000	2000	4000																		
Baffles 1200 x 300mm																								
$\alpha_p$ Row distances 300mm	0.15	0.25	0.45	0.90	0.90	0.95																		
<b>Fire reaction</b>		Euroclass <b>A2-s1,d0</b> as per EN 13501-1																						
<b>Humidity resistance</b>		<b>90%</b>																						
<b>Indoor air quality</b>		 A+	 E1	 IACG																				
<b>Cleanability</b>																								
<b>Sustainability</b>		 BIODEGRADABLE WOOL EC 1272/2008 Annex G																						

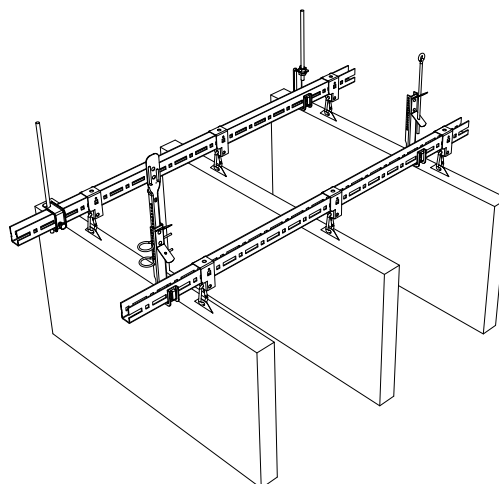
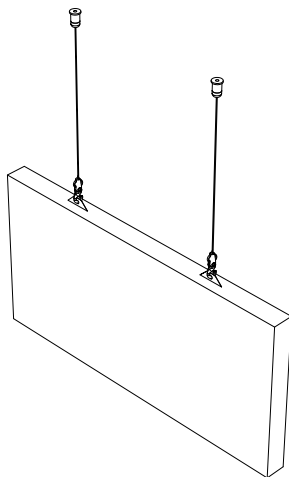



Vertical Baffle Systems

## **MINERAL Baffle Element Arc**

(OPTIMA Baffle Curves)

Individual / Grouped

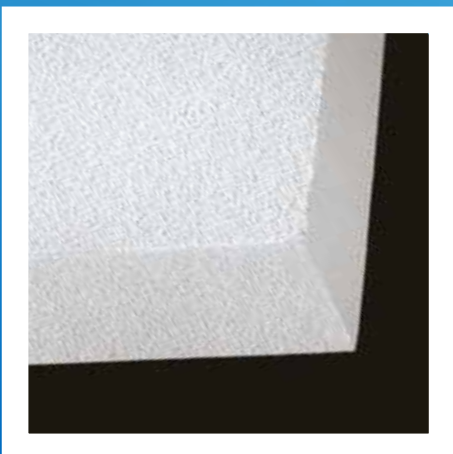







- With MINERAL Baffle Element Arc you can create exciting interiors without compromising acoustic performance, even with modern exposed soffit ceilings
- Modern curved appearance
- Reduce noise levels, increase speech intelligibility and reduce reverberation time in the space
- Install individually or in groups
- Typically used in schools, offices, leisure centres, transport hubs, etc.



# MINERAL Baffle Element Arc

Individual / Grouped

<b>Thickness (mm)</b>		39														
<b>Dimensions (mm)</b> Additional sizes on request		1200 x 400 1800 x 400														
<b>System</b>		Hanging Wire Kit U-Profile grouping option T-Grid Main Runner grouping option														
<b>Weight</b>		1200 x 400: 5.0 kg/pc 1800 x 400: 7.5 kg/pc														
<b>Colour &amp; design</b>		<div style="border: 1px solid #ccc; padding: 5px;">  White              Granite              Steel              Green Marble              Copper              Oak              Brass              Sandstone              Concrete         </div>														
<b>Sound absorption</b>		<p>EN ISO 354</p> <p><math>\alpha_w = 0.50(MH)</math> as per EN ISO 11654 - <b>Class D</b></p> <table border="1"> <thead> <tr> <th>Frequency <math>f</math> (Hz)</th> <th>125</th> <th>250</th> <th>500</th> <th>1000</th> <th>2000</th> <th>4000</th> </tr> </thead> <tbody> <tr> <td><math>\alpha_p</math> Row distances 300mm</td> <td>0.15</td> <td>0.25</td> <td>0.45</td> <td>0.90</td> <td>0.90</td> <td>0.95</td> </tr> </tbody> </table> <p>NRC = <b>0.65</b> as per ASTM C 423</p>	Frequency $f$ (Hz)	125	250	500	1000	2000	4000	$\alpha_p$ Row distances 300mm	0.15	0.25	0.45	0.90	0.90	0.95
Frequency $f$ (Hz)	125	250	500	1000	2000	4000										
$\alpha_p$ Row distances 300mm	0.15	0.25	0.45	0.90	0.90	0.95										
<b>Fire reaction</b>		Euroclass <b>A2-s1,d0</b> as per EN 13501-1														
<b>Humidity resistance</b>		<b>90%</b>														
<b>Indoor air quality</b>		 A+  E1  IACG														
<b>Cleanability</b>	 															
<b>Sustainability</b>																

MINERAL Baffle Element Arc

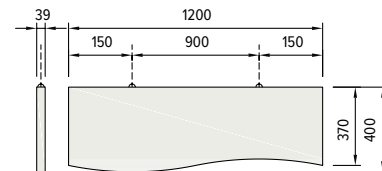
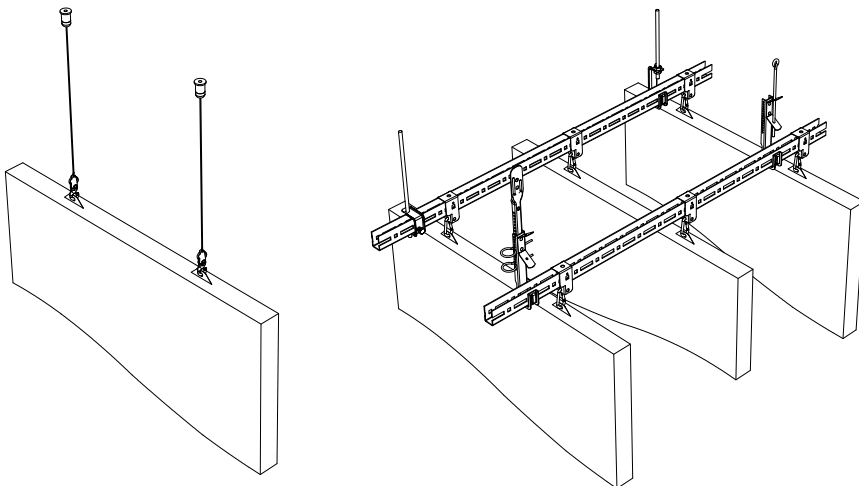

Module 1200 x 400 mm

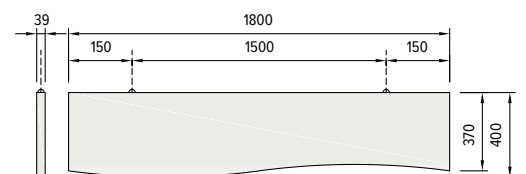

Module 1800 x 400 mm

 Options with this icon are available from our **Vario Design** range. Products may vary from country to country. Please contact your local sales representative. For further information and legal notice, please visit our website.





Vertical Baffle Systems

## **MINERAL Baffle Line L/N**

(THERMATEX® Baffle)

Individual / Grouped (only MINERAL Baffle Line L)























- MINERAL Baffle Line L and Line N features an aluminium frame and white laminate surface for a modern linear appearance. MINERAL Baffle Line L and Line N are also available in a variety of colours or customised graphic prints on request
- Good sound absorption: reduce noise levels, increase intelligibility and reduce reverberation time in a space
- Typically used to provide high levels of acoustic absorption in offices, leisure centres, transport hubs, etc





# MINERAL Baffle Line L/N

Individual / Grouped (only MINERAL Baffle Line L)

<b>Thickness (mm)</b>		50																						
<b>Dimensions (mm)</b> Additional sizes on request		1200 x 300 1200 x 400	1800 x 300 1800 x 400																					
<b>System</b>		MINERAL Baffle Line N - wire hanger with top screw thread MINERAL Baffle Line L - wire hanger with tab connector MINERAL Baffle Line L - U-Profile and carabiner with tab connector																						
<b>Weight</b>		1200 x 300: 3.2 kg/pc 1200 x 400: 4.1 kg/pc	1800 x 300: 4.7 kg/pc 1800 x 400: 6.0 kg/pc																					
<b>Colour &amp; design</b>		<b>Frame:</b> Anodised Aluminium, White, Colours  <b>White</b>  <b>Granite</b>  <b>Steel</b>  <b>Green Marble</b>  <b>Copper</b>  <b>Oak</b>  <b>Brass</b>  <b>Sandstone</b>  <b>Concrete</b>																						
		<b>Motif:</b> Custom Graphic Print																						
<b>Sound absorption</b>		EN ISO 354 $\alpha_w = \mathbf{0.60(MH)}$ (300mm) as per EN ISO 11654 - <b>Class C</b> <table border="1"> <thead> <tr> <th>Frequency <math>f</math> (Hz)</th> <th>125</th> <th>250</th> <th>500</th> <th>1000</th> <th>2000</th> <th>4000</th> </tr> </thead> <tbody> <tr> <td>Baffles 1200 x 300mm</td> <td></td> <td></td> <td></td> <td></td> <td></td> <td></td> </tr> <tr> <td><math>\alpha_p</math> Row distances 300mm</td> <td>0.35</td> <td>0.40</td> <td>0.55</td> <td>0.90</td> <td>0.90</td> <td>0.90</td> </tr> </tbody> </table> NRC = <b>0.65</b> as per ASTM C 423		Frequency $f$ (Hz)	125	250	500	1000	2000	4000	Baffles 1200 x 300mm							$\alpha_p$ Row distances 300mm	0.35	0.40	0.55	0.90	0.90	0.90
Frequency $f$ (Hz)	125	250	500	1000	2000	4000																		
Baffles 1200 x 300mm																								
$\alpha_p$ Row distances 300mm	0.35	0.40	0.55	0.90	0.90	0.90																		
<b>Fire reaction</b>		Euroclass <b>A2-s1,d0</b> as per EN 13501-1																						
<b>Light reflectance</b>		<b>88%</b>																						
<b>Humidity resistance</b>		<b>90%</b>																						
<b>Cleanability</b>	 																							
<b>Sustainability</b>																								

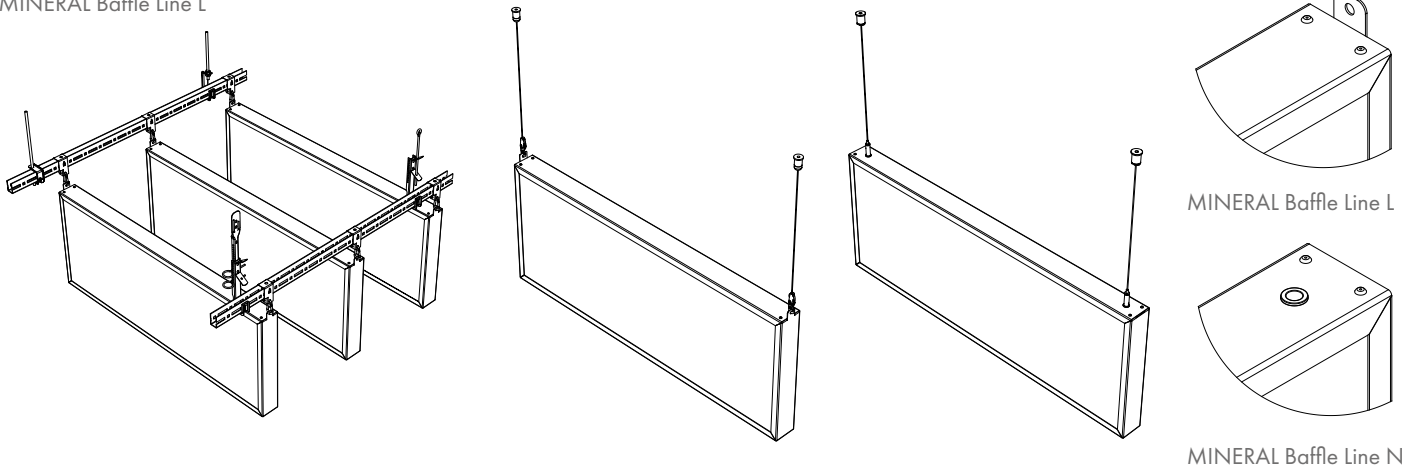
MINERAL Baffle Line L



 Options with this icon are available from our **Vario Design** range. Products may vary from country to country. Please contact your local sales representative. For further information and legal notice, please visit our website.





©Szymon Polański













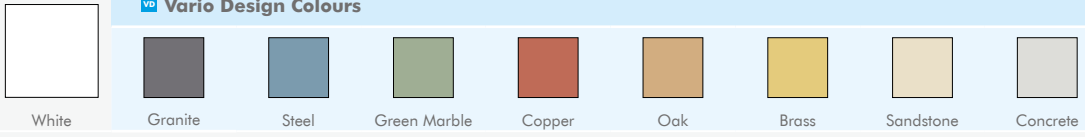

Floating Canopy Systems  
**MINERAL Sonic Element**  
(TOPIQ® Sonic Element, Optima Canopy)  
Individual / Grouped



- MINERAL Sonic Element is a frameless and jointless ceiling raft. It also benefits from a fully colour coated face and reverse laminate fleece
- The monolithic ceiling raft design offers excellent sound absorption properties and when installed gives the appearance of a free floating ceiling cloud

# MINERAL Sonic Element

Individual / Grouped

<b>Thickness (mm)</b>		40																																										
<b>Dimensions (mm)</b> Additional sizes and shapes on request		<table border="0"> <tr> <td>Trapezoid</td> <td>1180 x 870</td> <td>Rectangle</td> <td>1780 x 1180</td> </tr> <tr> <td>Hexagon</td> <td>1363 x 1180</td> <td>Rectangle</td> <td>2380 x 1180</td> </tr> <tr> <td>Left Parallelogram</td> <td>1180 x 1180</td> <td>Circle</td> <td>Ø800</td> </tr> <tr> <td>Right Parallelogram</td> <td>1180 x 1180</td> <td>Circle</td> <td>Ø1200</td> </tr> <tr> <td>Square</td> <td>800 x 800</td> <td>Circle</td> <td>Ø1600</td> </tr> <tr> <td>Square</td> <td>1180 x 1180</td> <td>Convex</td> <td>1170 x 1170</td> </tr> <tr> <td>Rectangle</td> <td>1180 x 580</td> <td>Concave</td> <td>1170 x 1020</td> </tr> <tr> <td>Rectangle</td> <td>1780 x 880</td> <td>Triangle</td> <td>1180 x 1022</td> </tr> </table>	Trapezoid	1180 x 870	Rectangle	1780 x 1180	Hexagon	1363 x 1180	Rectangle	2380 x 1180	Left Parallelogram	1180 x 1180	Circle	Ø800	Right Parallelogram	1180 x 1180	Circle	Ø1200	Square	800 x 800	Circle	Ø1600	Square	1180 x 1180	Convex	1170 x 1170	Rectangle	1180 x 580	Concave	1170 x 1020	Rectangle	1780 x 880	Triangle	1180 x 1022										
Trapezoid	1180 x 870	Rectangle	1780 x 1180																																									
Hexagon	1363 x 1180	Rectangle	2380 x 1180																																									
Left Parallelogram	1180 x 1180	Circle	Ø800																																									
Right Parallelogram	1180 x 1180	Circle	Ø1200																																									
Square	800 x 800	Circle	Ø1600																																									
Square	1180 x 1180	Convex	1170 x 1170																																									
Rectangle	1180 x 580	Concave	1170 x 1020																																									
Rectangle	1780 x 880	Triangle	1180 x 1022																																									
<b>System</b>		Individual: Wire Hanger Grouped: U-Profile																																										
<b>Weight</b>		6.0 kg/m <sup>2</sup>																																										
<b>Colour &amp; design</b>		<p><b>VD Vario Design Colours</b></p>  <p>White Granite Steel Green Marble Copper Oak Brass Sandstone Concrete</p>																																										
<b>Sound absorption</b>		<p>EN ISO 354</p> <table border="1"> <thead> <tr> <th>Frequency f (Hz)</th> <th>125</th> <th>250</th> <th>500</th> <th>1000</th> <th>2000</th> <th>4000</th> </tr> </thead> <tbody> <tr> <td>Equivalent Absorption Area Aobj*</td> <td></td> <td></td> <td></td> <td></td> <td></td> <td></td> </tr> <tr> <td>Square: 1180 x 1180mm / Suspension height 190mm</td> <td>0.40</td> <td>1.20</td> <td>2.20</td> <td>2.40</td> <td>2.40</td> <td>2.30</td> </tr> <tr> <td>Rectangle: 1780 x 1180mm / Suspension height 190mm</td> <td>0.80</td> <td>2.10</td> <td>3.10</td> <td>3.30</td> <td>3.50</td> <td>3.40</td> </tr> <tr> <td>Rectangle: 2380 x 1180mm / Suspension height 190mm</td> <td>0.80</td> <td>2.70</td> <td>4.20</td> <td>4.40</td> <td>4.50</td> <td>4.30</td> </tr> <tr> <td>Circle: Ø1200mm / Suspension height 150mm</td> <td>0.40</td> <td>1.00</td> <td>1.70</td> <td>1.80</td> <td>2.00</td> <td>1.90</td> </tr> </tbody> </table> <p>* Values shown are the average of the 3 one third octave band values</p>	Frequency f (Hz)	125	250	500	1000	2000	4000	Equivalent Absorption Area Aobj*							Square: 1180 x 1180mm / Suspension height 190mm	0.40	1.20	2.20	2.40	2.40	2.30	Rectangle: 1780 x 1180mm / Suspension height 190mm	0.80	2.10	3.10	3.30	3.50	3.40	Rectangle: 2380 x 1180mm / Suspension height 190mm	0.80	2.70	4.20	4.40	4.50	4.30	Circle: Ø1200mm / Suspension height 150mm	0.40	1.00	1.70	1.80	2.00	1.90
Frequency f (Hz)	125	250	500	1000	2000	4000																																						
Equivalent Absorption Area Aobj*																																												
Square: 1180 x 1180mm / Suspension height 190mm	0.40	1.20	2.20	2.40	2.40	2.30																																						
Rectangle: 1780 x 1180mm / Suspension height 190mm	0.80	2.10	3.10	3.30	3.50	3.40																																						
Rectangle: 2380 x 1180mm / Suspension height 190mm	0.80	2.70	4.20	4.40	4.50	4.30																																						
Circle: Ø1200mm / Suspension height 150mm	0.40	1.00	1.70	1.80	2.00	1.90																																						
<b>Fire reaction</b>		Euroclass <b>A2-s1,d0</b> as per EN 13501-1																																										
<b>Light reflectance</b>		Up to <b>88%</b>																																										
<b>Humidity resistance</b>		<b>90%</b>																																										
<b>Indoor air quality</b>		 <p>A E1 IAC</p>																																										
<b>Cleanability</b>																																												
<b>Sustainability</b>		 <p>BIOSOLUBLE WOOL EC 1272/2008 Annex G</p>																																										

Flexible design and adjustable to various heights using steel cables.

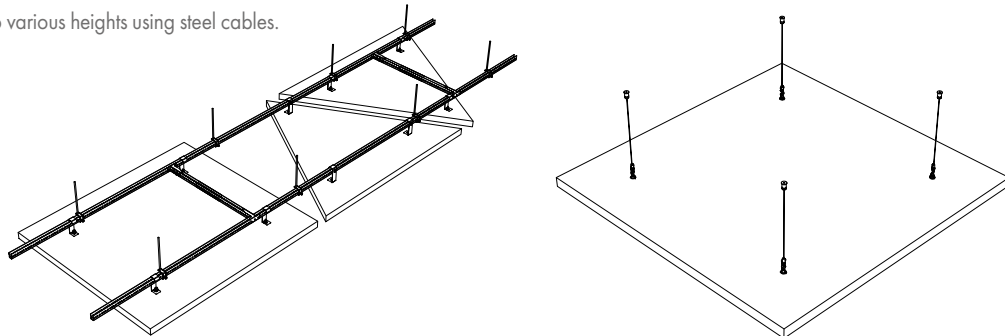

**VD** Options with this icon are available from our **Vario Design** range. Products may vary from country to country. Please contact your local sales representative. For further information and legal notice, please visit our website.



Floating Canopy Systems  
**MINERAL Sonic Line Arc**  
(THERMATEX® Sonic Arc)  
Individual











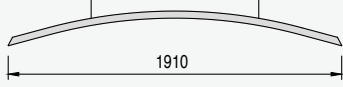
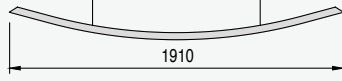











- Create unique, elegant designs with an array of MINERAL Sonic Line Arc concave and convex canopies
- Play with custom colours to create exciting contrasting effects
- MINERAL Sonic Line Arc allows you express your creativity and accentuate an area using new spacial effects



# MINERAL Sonic Line Arc

Individual

<b>Edge details</b>		<b>MINERAL Sonic Line Arc Concave</b> 	<b>MINERAL Sonic Line Arc Convex</b> 																					
<b>Thickness (mm)</b>		35																						
<b>Dimensions (mm)</b>		1910 x 1180																						
<b>System</b>		Wire Hanger																						
<b>Weight</b>		16.0 kg/pc																						
<b>Colour &amp; design</b>		 White  Granite  Steel  Green Marble  Copper  Oak  Brass  Sandstone  Concrete																						
<b>Sound absorption</b>		EN ISO 354 <table border="1"> <thead> <tr> <th>Frequency f (Hz)</th> <th>125</th> <th>250</th> <th>500</th> <th>1000</th> <th>2000</th> <th>4000</th> </tr> </thead> <tbody> <tr> <td>Equivalent Absorption Area Aobj*</td> <td></td> <td></td> <td></td> <td></td> <td></td> <td></td> </tr> <tr> <td>Suspension height 185mm</td> <td>0.40</td> <td>1.60</td> <td>2.40</td> <td>2.70</td> <td>3.20</td> <td>3.40</td> </tr> </tbody> </table> <p>*Values shown are the average of the 3 one third octave band values</p>		Frequency f (Hz)	125	250	500	1000	2000	4000	Equivalent Absorption Area Aobj*							Suspension height 185mm	0.40	1.60	2.40	2.70	3.20	3.40
Frequency f (Hz)	125	250	500	1000	2000	4000																		
Equivalent Absorption Area Aobj*																								
Suspension height 185mm	0.40	1.60	2.40	2.70	3.20	3.40																		
<b>Fire reaction</b>		Euroclass <b>A2-s1,d0</b> as per EN 13501-1																						
<b>Light reflectance</b>		Up to <b>88%</b>																						
<b>Humidity resistance</b>		<b>90%</b>																						
<b>Cleanability</b>	 																							
<b>Sustainability</b>																								

MINERAL Sonic Line Arc Concave

MINERAL Sonic Line Arc Convex

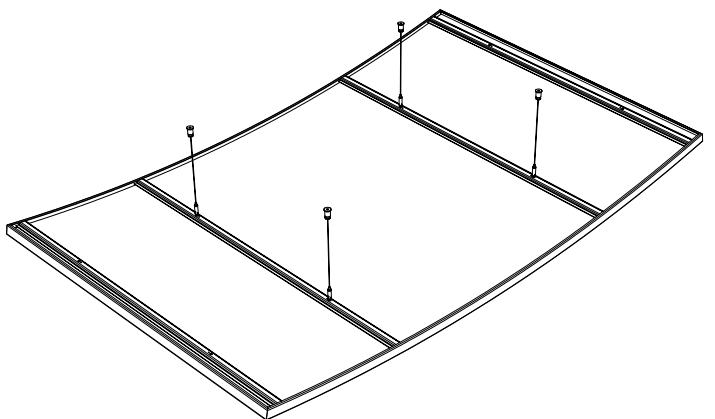
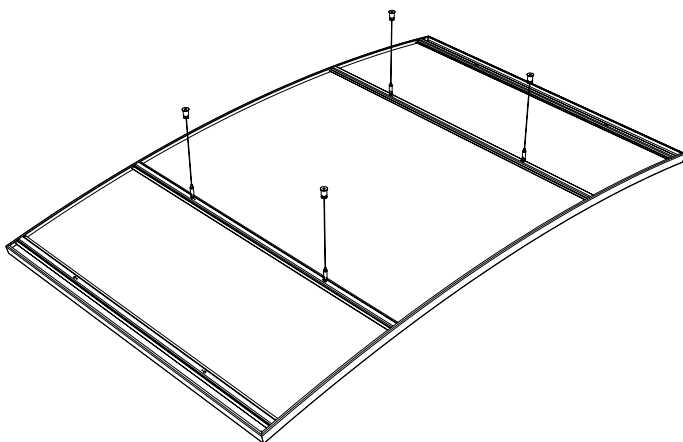

Ceiling rafts are delivered in one piece making them quick and easy to install. Flexible design and adjustable to various heights using steel cables.

 Options with this icon are available from our **Vario Design** range. Products may vary from country to country. Please contact your local sales representative. For further information and legal notice, please visit our website.



























Floating Canopy Systems  
**MINERAL Sonic Line**  
(THERMATEX® Sonic Modern)  
Individual

4





- MINERAL Sonic Line is a ceiling raft with an aluminium frame. The flexible suspension with fine, steel cables enables the height to be individually adjusted as required
- Available with a standard white laminate surface and can be customised in a variety of colours or bespoke printed motifs on request
- Aesthetically defines spaces in schools, offices leisure centres, retail spaces etc.

Floating Canopy Systems  
**MINERAL Sonic Line**  
 Individual

<b>Thickness (mm)</b>		43																												
<b>Dimensions (mm)</b>		1200 x 600 1200 x 1200 1800 x 1200 2400 x 1200																												
<b>System</b>		Wire Hanger																												
<b>Weight</b>		1200 x 600: 5.0 kg/pc 1200 x 1200: 10.0 kg/pc 1800 x 1200: 15.0 kg/pc 2400 x 1200: 20.0 kg/pc																												
<b>Colour &amp; design</b>		<p><b>Frame:</b> Anodised Aluminium, White, Colours</p> <div style="display: flex; align-items: center;"> <div style="border: 1px solid black; width: 40px; height: 40px; background-color: white; margin-right: 10px;"></div> <div style="background-color: #ADD8E6; padding: 2px;">  <b>Vario Design Colours</b> </div> </div> <div style="display: flex; justify-content: space-around; margin-top: 5px;"> <div style="text-align: center;"> White</div> <div style="text-align: center;"> Granite</div> <div style="text-align: center;"> Steel</div> <div style="text-align: center;"> Green Marble</div> <div style="text-align: center;"> Copper</div> <div style="text-align: center;"> Oak</div> <div style="text-align: center;"> Brass</div> <div style="text-align: center;"> Sandstone</div> <div style="text-align: center;"> Concrete</div> </div> <p><b>Motif:</b> Custom Graphic Print</p>																												
<b>Sound absorption</b>		<p>EN ISO 354</p> <table border="1" style="width: 100%; border-collapse: collapse;"> <thead> <tr> <th>Frequency <i>f</i> (Hz)</th> <th>125</th> <th>250</th> <th>500</th> <th>1000</th> <th>2000</th> <th>4000</th> </tr> </thead> <tbody> <tr> <td>Equivalent Absorption Area <i>Aobj</i>*</td> <td></td> <td></td> <td></td> <td></td> <td></td> <td></td> </tr> <tr> <td>1200 x 1200mm Suspension height 193mm</td> <td>0.40</td> <td>1.10</td> <td>1.60</td> <td>2.00</td> <td>2.10</td> <td>2.00</td> </tr> <tr> <td>2400 x 1200mm Suspension height 193mm</td> <td>0.90</td> <td>1.90</td> <td>3.00</td> <td>3.40</td> <td>3.80</td> <td>3.70</td> </tr> </tbody> </table> <p style="text-align: right; font-size: small;">* Values shown are the average of the 3 one third octave band values</p>	Frequency <i>f</i> (Hz)	125	250	500	1000	2000	4000	Equivalent Absorption Area <i>Aobj</i> *							1200 x 1200mm Suspension height 193mm	0.40	1.10	1.60	2.00	2.10	2.00	2400 x 1200mm Suspension height 193mm	0.90	1.90	3.00	3.40	3.80	3.70
Frequency <i>f</i> (Hz)	125	250	500	1000	2000	4000																								
Equivalent Absorption Area <i>Aobj</i> *																														
1200 x 1200mm Suspension height 193mm	0.40	1.10	1.60	2.00	2.10	2.00																								
2400 x 1200mm Suspension height 193mm	0.90	1.90	3.00	3.40	3.80	3.70																								
<b>Fire reaction</b>		Euroclass <b>A2-s1,d0</b> as per EN 13501-1																												
<b>Light reflectance</b>		Up to <b>88%</b>																												
<b>Humidity resistance</b>		<b>90%</b>																												
<b>Cleanability</b>	 																													
<b>Sustainability</b>		<p><b>BIODISSOLUBLE WOOL</b></p> <p>EC 1272/2008 Annex G</p>																												

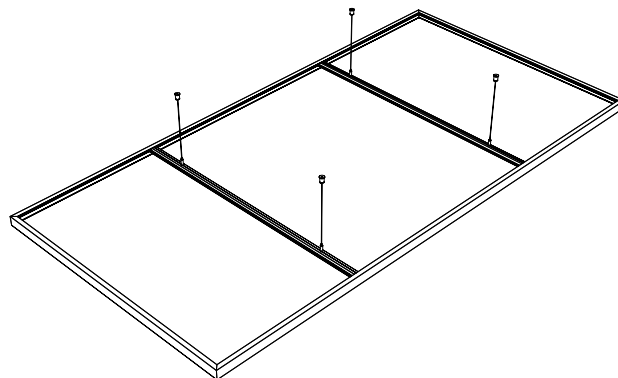
Ceiling rafts are delivered in one piece making them quick and easy to install. Flexible design and adjustable to various heights using steel cables.



 Options with this icon are available from our **Vario Design** range. Products may vary from country to country. Please contact your local sales representative. For further information and legal notice, please visit our website.





©Philip Durran

Wall Systems

## MINERAL Wallcoustic Element

(OPTIMA Canopy, OPTIMA L Canopy, TOPIQ® Line Element)

Individual























- MINERAL Wallcoustic Element is a frameless and jointless wall absorber. It also benefits from a fully colour coated face and reverse laminate fleece
- The monolithic wall absorber offers excellent sound absorption properties and endless design possibilities for ambitious architects, who seek to raise the visual and acoustic quality of interior spaces
- The wall panel is delivered in one piece and is quick and easy to install using spiral anchors and wall brackets



# MINERAL Wallcoustic Element

Individual

<b>Thickness (mm)</b>		40																												
<b>Dimensions (mm)</b>		Square 1180 x 1180 Square 800 x 800 Rectangle 1180 x 580 Rectangle 1780 x 880 Rectangle 1780 x 1180																												
Additional sizes on request																														
<b>System</b>		Spiral anchor Wall brackets																												
<b>Weight</b>		6.0 kg/m <sup>2</sup>																												
<b>Colour &amp; design</b>		<div style="border: 1px solid #ccc; padding: 5px;"> <p><b>VD Vario Design Colours</b></p> <div style="display: flex; justify-content: space-around; align-items: center;"> <div style="text-align: center;">  White                 </div> <div style="text-align: center;">  Granite                 </div> <div style="text-align: center;">  Steel                 </div> <div style="text-align: center;">  Green Marble                 </div> <div style="text-align: center;">  Copper                 </div> <div style="text-align: center;">  Oak                 </div> <div style="text-align: center;">  Brass                 </div> <div style="text-align: center;">  Sandstone                 </div> <div style="text-align: center;">  Concrete                 </div> </div> </div>																												
<b>Sound absorption</b>		<p>EN ISO 354</p> <table border="1"> <thead> <tr> <th>Frequency f (Hz)</th> <th>125</th> <th>250</th> <th>500</th> <th>1000</th> <th>2000</th> <th>4000</th> </tr> </thead> <tbody> <tr> <td>Equivalent Absorption Area Aobj*</td> <td></td> <td></td> <td></td> <td></td> <td></td> <td></td> </tr> <tr> <td>Square: 1180 x 1180mm</td> <td>0.40</td> <td>1.20</td> <td>1.90</td> <td>1.90</td> <td>1.90</td> <td>1.80</td> </tr> <tr> <td>Rectangle: 1780 x 1180mm</td> <td>0.50</td> <td>1.70</td> <td>2.70</td> <td>2.80</td> <td>2.80</td> <td>2.60</td> </tr> </tbody> </table> <p>*Values shown are the average of the 3 one third octave band values</p>	Frequency f (Hz)	125	250	500	1000	2000	4000	Equivalent Absorption Area Aobj*							Square: 1180 x 1180mm	0.40	1.20	1.90	1.90	1.90	1.80	Rectangle: 1780 x 1180mm	0.50	1.70	2.70	2.80	2.80	2.60
Frequency f (Hz)	125	250	500	1000	2000	4000																								
Equivalent Absorption Area Aobj*																														
Square: 1180 x 1180mm	0.40	1.20	1.90	1.90	1.90	1.80																								
Rectangle: 1780 x 1180mm	0.50	1.70	2.70	2.80	2.80	2.60																								
<b>Fire reaction</b>		Euroclass <b>A2-s1,d0</b> as per EN 13501-1																												
<b>Light reflectance</b>		Up to <b>88%</b>																												
<b>Humidity resistance</b>		<b>90%</b>																												
<b>Cleanability</b>	 																													
<b>Sustainability</b>																														

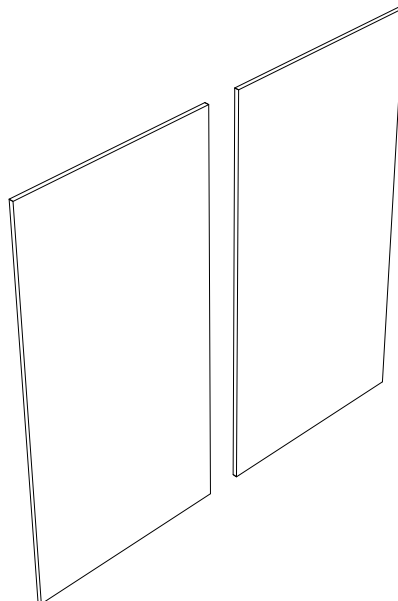

**VD** Options with this icon are available from our **Vario Design** range. Products may vary from country to country. Please contact your local sales representative. For further information and legal notice, please visit our website.



Wall Systems

## MINERAL Wallcoustic Line

(THERMATEX® Line Modern)

Individual















- MINERAL Wallcoustic Line is a pre-assembled aluminium framed wall absorber with a standard white, laminate surface finish. It can also be ordered in a variety of colours or customised printed motifs on request
- Customise and enhance the visual appearance and acoustic ambience in any space
- The wall panel is delivered in one piece and is quick and easy to install using eccentric screws and installation key



# MINERAL Wallcoustic Line

Individual

<b>Thickness (mm)</b>		43																																										
<b>Dimensions (mm)</b> Additional sizes on request		1200 x 600 1200 x 1200 1800 x 1200 2400 x 1200																																										
<b>System</b>		Eccentric bracket																																										
<b>Weight</b>		9.4 kg/m <sup>2</sup>																																										
<b>Colour &amp; design</b>		<p><b>Frame:</b> Anodised Aluminium, White, Colours</p> <div style="display: flex; align-items: center;"> <div style="border: 1px solid black; width: 40px; height: 40px; background-color: white; margin-right: 10px;"></div> <div style="text-align: center;"> <p><small>VD</small> <b>Vario Design Colours</b></p> <div style="display: flex; justify-content: space-around; gap: 10px;"> <div style="width: 20px; height: 20px; background-color: #444;"></div> <div style="width: 20px; height: 20px; background-color: #557788;"></div> <div style="width: 20px; height: 20px; background-color: #779966;"></div> <div style="width: 20px; height: 20px; background-color: #993333;"></div> <div style="width: 20px; height: 20px; background-color: #996633;"></div> <div style="width: 20px; height: 20px; background-color: #cc9933;"></div> <div style="width: 20px; height: 20px; background-color: #e6e6e6;"></div> </div> <div style="display: flex; justify-content: space-around; font-size: 8px; margin-top: 2px;"> <span>White</span> <span>Granite</span> <span>Steel</span> <span>Green Marble</span> <span>Copper</span> <span>Oak</span> <span>Brass</span> <span>Sandstone</span> <span>Concrete</span> </div> </div> </div> <p><b>Motif:</b> Custom Graphic Print</p>																																										
<b>Sound absorption</b>		<p>EN ISO 354</p> <table border="1" style="width: 100%; border-collapse: collapse; font-size: 8px;"> <thead> <tr> <th>Frequency f (Hz)</th> <th>125</th> <th>250</th> <th>500</th> <th>1000</th> <th>2000</th> <th>4000</th> </tr> </thead> <tbody> <tr> <td>Equivalent Absorption Area Aobj*</td> <td></td> <td></td> <td></td> <td></td> <td></td> <td></td> </tr> <tr> <td>Rectangle: 1200 x 600mm</td> <td>0.20</td> <td>0.60</td> <td>1.00</td> <td>0.90</td> <td>0.80</td> <td>0.90</td> </tr> <tr> <td>Square: 1200 x 1200mm</td> <td>0.50</td> <td>1.10</td> <td>1.60</td> <td>1.50</td> <td>1.50</td> <td>1.50</td> </tr> <tr> <td>Rectangle: 1800 x 1200mm</td> <td>0.60</td> <td>1.90</td> <td>2.50</td> <td>2.40</td> <td>2.20</td> <td>2.40</td> </tr> <tr> <td>Rectangle: 2400 x 1200mm</td> <td>1.10</td> <td>2.20</td> <td>3.10</td> <td>3.10</td> <td>3.00</td> <td>3.10</td> </tr> </tbody> </table> <p style="text-align: right; font-size: 8px; margin-top: 5px;">*Values shown are the average of the 3 one third octave band values</p>	Frequency f (Hz)	125	250	500	1000	2000	4000	Equivalent Absorption Area Aobj*							Rectangle: 1200 x 600mm	0.20	0.60	1.00	0.90	0.80	0.90	Square: 1200 x 1200mm	0.50	1.10	1.60	1.50	1.50	1.50	Rectangle: 1800 x 1200mm	0.60	1.90	2.50	2.40	2.20	2.40	Rectangle: 2400 x 1200mm	1.10	2.20	3.10	3.10	3.00	3.10
Frequency f (Hz)	125	250	500	1000	2000	4000																																						
Equivalent Absorption Area Aobj*																																												
Rectangle: 1200 x 600mm	0.20	0.60	1.00	0.90	0.80	0.90																																						
Square: 1200 x 1200mm	0.50	1.10	1.60	1.50	1.50	1.50																																						
Rectangle: 1800 x 1200mm	0.60	1.90	2.50	2.40	2.20	2.40																																						
Rectangle: 2400 x 1200mm	1.10	2.20	3.10	3.10	3.00	3.10																																						
<b>Fire reaction</b>		Euroclass <b>A2-s1,d0</b> as per EN 13501-1																																										
<b>Light reflectance</b>		Up to <b>88%</b>																																										
<b>Humidity resistance</b>		<b>90%</b>																																										
<b>Cleanability</b>	 																																											
<b>Sustainability</b>																																												

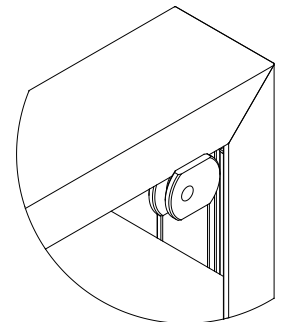
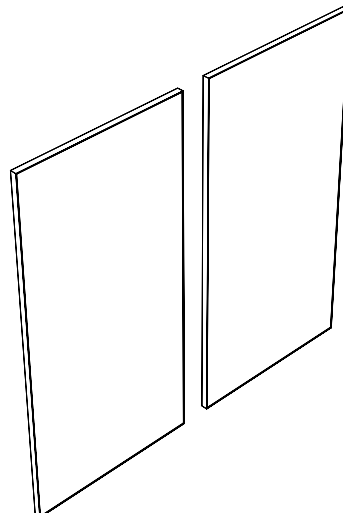

Detail: Eccentric bracket

VD Options with this icon are available from our **Vario Design** range. Products may vary from country to country. Please contact your local sales representative. For further information and legal notice, please visit our website.



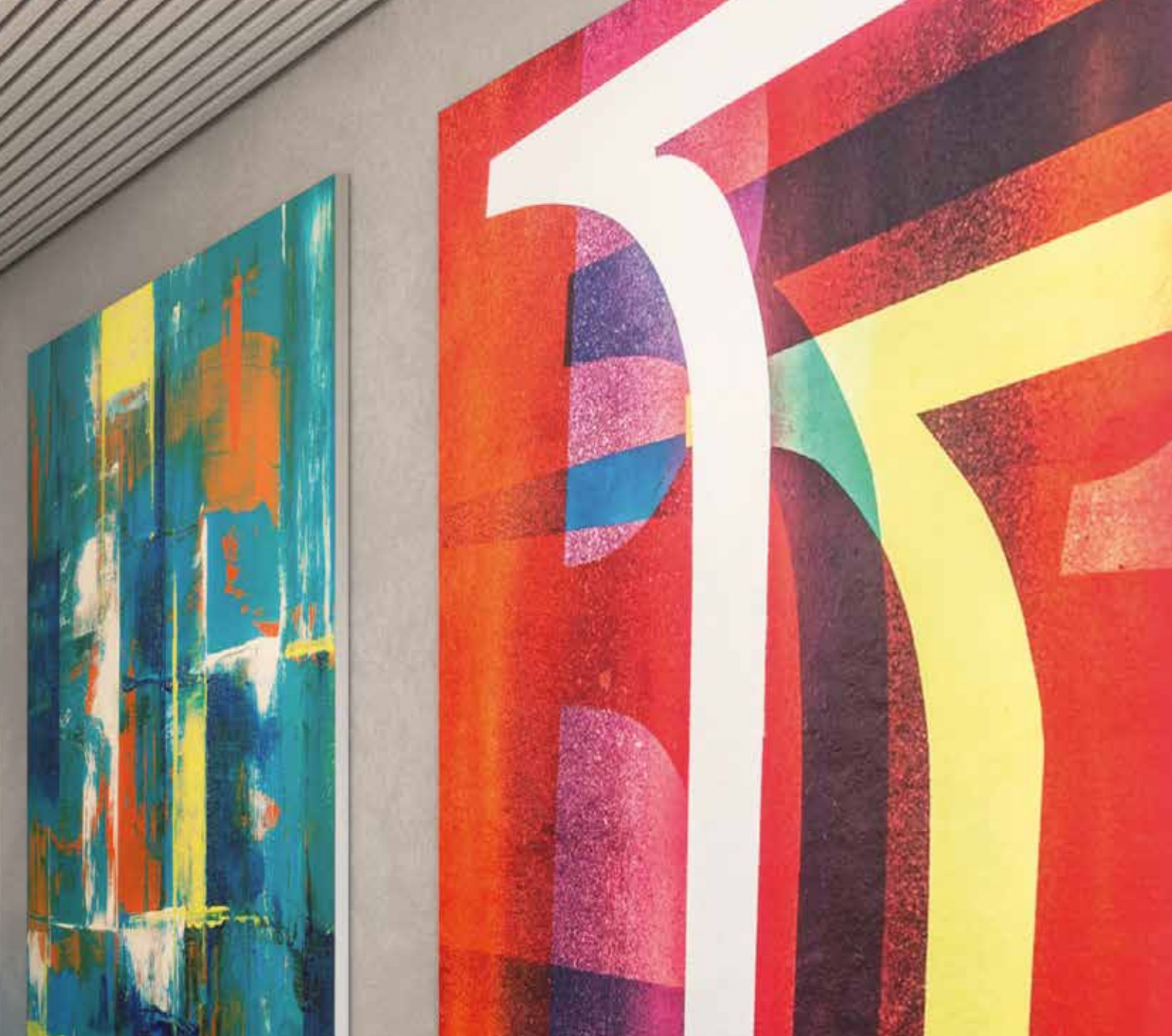

Wall Systems  
**FABRIC Wallcoustic Line**  
(LINE Style)  
Individual











- FABRIC Wallcoustic Line is a fabric covered wall absorber with an elegant aluminium frame and can be easily customised using individual patterns or images. The aluminium frame is supplied with an all-round groove into which the printed fabric is inserted. The fabric covering can be easily removed and replaced with a new fabric design, without using any special tools
- FABRIC Wallcoustic Line 20: Lightweight profile for one-sided coverings in small sizes
- FABRIC Wallcoustic Line 27: Profile for all sizes with one-sided coverings
- FABRIC Wallcoustic Line 50: Profile for all sizes with one-sided coverings and a highly absorbing acoustic filling





# FABRIC Wallcoustic Line

Individual

<b>Thickness (mm)</b>		20	27	50																						
<b>Dimensions (mm)</b>		600 x 600 1 200 x 600	1200 x 1200 1800 x 1200 2400 x 1200 2400 x 2400	600 x 600 1200 x 600 1200 x 1200 1800 x 1200 2400 x 1200 2400 x 2400																						
<b>System</b>		Wall bracket																								
<b>Weight</b>		3.0 - 6.0 kg/m <sup>2</sup>																								
<b>Colour &amp; design</b>		<b>Frame:</b> anodised aluminium, white, RAL colours <b>FABRIC Wallcoustic Line 20:</b> fabric, white or Custom Graphic Print <b>FABRIC Wallcoustic Line 27:</b> fabric, white or Custom Graphic Print <b>FABRIC Wallcoustic Line 50:</b> fabric, white or Custom Graphic Print																								
<b>Sound absorption</b>		EN ISO 354 <table border="1"> <thead> <tr> <th>Frequency f (Hz)</th> <th>125</th> <th>250</th> <th>500</th> <th>1000</th> <th>2000</th> <th>4000</th> </tr> </thead> <tbody> <tr> <td>Equivalent Absorption Area Aobj*</td> <td></td> <td></td> <td></td> <td></td> <td></td> <td></td> </tr> <tr> <td>1200 x 1200mm (50mm thickness)</td> <td>0.30</td> <td>0.90</td> <td>1.90</td> <td>1.90</td> <td>1.80</td> <td>1.60</td> </tr> </tbody> </table> <p>*Values shown are the average of the 3 one third octave band values</p>				Frequency f (Hz)	125	250	500	1000	2000	4000	Equivalent Absorption Area Aobj*							1200 x 1200mm (50mm thickness)	0.30	0.90	1.90	1.90	1.80	1.60
Frequency f (Hz)	125	250	500	1000	2000	4000																				
Equivalent Absorption Area Aobj*																										
1200 x 1200mm (50mm thickness)	0.30	0.90	1.90	1.90	1.80	1.60																				
<b>Humidity resistance</b>		90%																								
<b>Cleanability</b>	 																									

FABRIC Wallcoustic Line

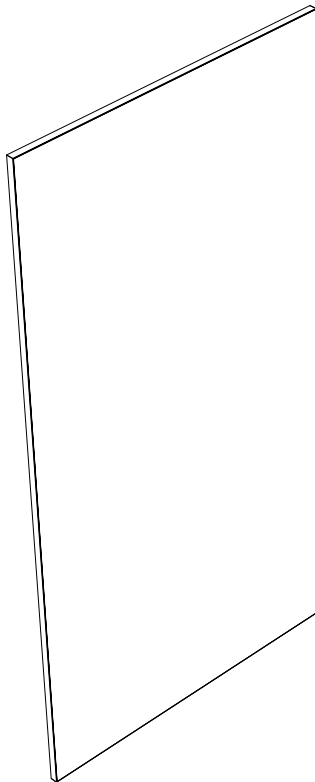

Profile cross-sections

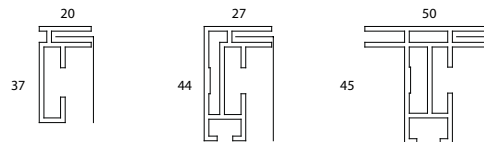

Corner connection

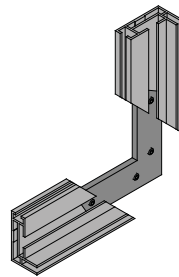

Detail frame

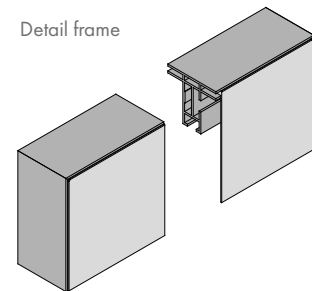





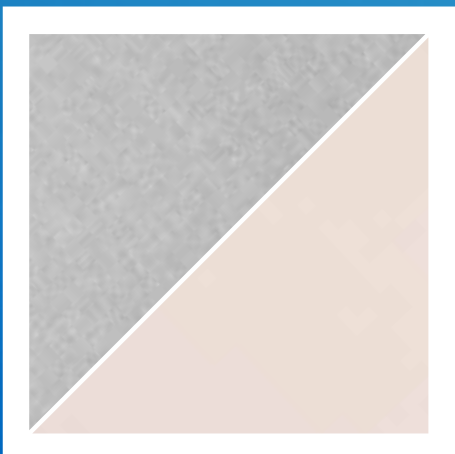







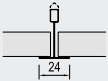















































## AMF THERMATEX® Alpha Colour



- AMF THERMATEX® Alpha Colour provides a modern appearance and is the optimal solution for spaces that require outstanding sound absorption. In addition to cream, black and silver, the acoustic range is also available in granite, steel, green marble, copper, oak, brass, sandstone and concrete Vario Design colours
- Excellent sound absorption (0.95  $\alpha_w$ )
- Ideal for offices, restaurants, cinemas, classrooms and learning applications



# AMF THERMATEX<sup>®</sup> ALPHA COLOUR

<b>Edge details</b> Additional edge details on request	Board 																																				
<b>Thickness (mm)</b>	19																																				
<b>Dimensions (mm)</b> Additional sizes on request	<table border="0"> <tr> <td>600 x 600</td> <td>1200 x 600</td> </tr> <tr> <td>610 x 610</td> <td>1220 x 610</td> </tr> <tr> <td>625 x 625</td> <td>1250 x 625</td> </tr> </table>	600 x 600	1200 x 600	610 x 610	1220 x 610	625 x 625	1250 x 625																														
600 x 600	1200 x 600																																				
610 x 610	1220 x 610																																				
625 x 625	1250 x 625																																				
<b>System</b>	Exposed demountable - System C																																				
<b>Weight</b>	3.3 kg / m <sup>2</sup>																																				
<b>Colour</b> Additional colours on request	<table border="0"> <tr> <td colspan="12">  </td> </tr> <tr> <td></td> <td></td> <td></td> <td></td> <td></td> <td></td> <td></td> <td></td> <td></td> <td></td> <td></td> <td></td> </tr> <tr> <td>Black</td> <td>Silver</td> <td>Cream</td> <td>Granite</td> <td>Steel</td> <td>Green Marble</td> <td>Copper</td> <td>Oak</td> <td>Brass</td> <td>Sandstone</td> <td>Concrete</td> <td></td> </tr> </table>																									Black	Silver	Cream	Granite	Steel	Green Marble	Copper	Oak	Brass	Sandstone	Concrete	
																																					
																																					
Black	Silver	Cream	Granite	Steel	Green Marble	Copper	Oak	Brass	Sandstone	Concrete																											
<b>Sound absorption</b>	EN ISO 354 $\alpha_w = 1.00$ as per EN ISO 11654 - <b>Class A</b> (Black) $\alpha_w = 0.95$ as per EN ISO 11654 - <b>Class A</b> (other colours) <table border="1" data-bbox="485 981 1474 1055"> <thead> <tr> <th>Frequency f (Hz)</th> <th>125</th> <th>250</th> <th>500</th> <th>1000</th> <th>2000</th> <th>4000</th> </tr> </thead> <tbody> <tr> <td><math>\alpha_p</math> Black</td> <td>0.45</td> <td>0.80</td> <td>0.95</td> <td>0.95</td> <td>1.00</td> <td>1.00</td> </tr> </tbody> </table> <table border="1" data-bbox="485 1070 1474 1144"> <thead> <tr> <th>Frequency f (Hz)</th> <th>125</th> <th>250</th> <th>500</th> <th>1000</th> <th>2000</th> <th>4000</th> </tr> </thead> <tbody> <tr> <td><math>\alpha_p</math> Other colours</td> <td>0.50</td> <td>0.80</td> <td>0.90</td> <td>0.90</td> <td>1.00</td> <td>1.00</td> </tr> </tbody> </table> NRC = <b>0.90</b> as per ASTM C 423	Frequency f (Hz)	125	250	500	1000	2000	4000	$\alpha_p$ Black	0.45	0.80	0.95	0.95	1.00	1.00	Frequency f (Hz)	125	250	500	1000	2000	4000	$\alpha_p$ Other colours	0.50	0.80	0.90	0.90	1.00	1.00								
Frequency f (Hz)	125	250	500	1000	2000	4000																															
$\alpha_p$ Black	0.45	0.80	0.95	0.95	1.00	1.00																															
Frequency f (Hz)	125	250	500	1000	2000	4000																															
$\alpha_p$ Other colours	0.50	0.80	0.90	0.90	1.00	1.00																															
<b>Sound attenuation</b>	EN ISO 10848-2 $D_{n,f,w} = 28$ dB as per EN ISO 717-1 CAC = <b>29 dB</b> as per ASTM E 413-10																																				
<b>Sound reduction</b>	EN ISO 10140-2 $R_w = 14$ dB as per EN ISO 717-1																																				
<b>Fire reaction</b>	Euroclass <b>A2-s1, d0</b> as per EN 13501-1 RUS <b>KM1 (G1, V1, D1, T1)</b> as per 123-FZ																																				
<b>Thermal conductivity</b>	$\lambda = 0.040$ W/mk as per EN 12667																																				
<b>Air permeability</b>	<b>PM1</b> ( $\leq 30$ m <sup>3</sup> /hm <sup>2</sup> ) as per DIN 18177																																				
<b>Humidity resistance</b>	<b>95% RH</b>																																				
<b>Indoor air quality</b>	<table border="0"> <tr> <td></td> <td></td> </tr> <tr> <td>A+</td> <td>E1</td> </tr> </table>			A+	E1																																
																																					
A+	E1																																				
<b>Cleanability</b>	<table border="0"> <tr> <td></td> <td></td> </tr> </table>																																				
																																					
<b>Sustainability</b>	<table border="0"> <tr> <td></td> <td></td> <td></td> </tr> <tr> <td>43%</td> <td>EC 1272/2008 Annex O</td> <td><a href="http://www.blauer-engel.de/uz132">www.blauer-engel.de/uz132</a></td> </tr> </table>				43%	EC 1272/2008 Annex O	<a href="http://www.blauer-engel.de/uz132">www.blauer-engel.de/uz132</a>																														
																																					
43%	EC 1272/2008 Annex O	<a href="http://www.blauer-engel.de/uz132">www.blauer-engel.de/uz132</a>																																			

<sup>VO</sup> Options with this icon are available from our **Vario Design** range. Products may vary from country to country. Please contact your local sales representative. For further information and legal notice, please visit our website.



# EXPERIENCE MORE POSSIBILITIES



## **AMF THERMATEX® Varioline**

With AMF THERMATEX® Varioline, the individual design possibilities are almost limitless.

Whichever architectural look and feel you have in mind, you can choose from a selection of mineral tiles with wood, concrete or metal pattern surfaces to achieve the desired visual aesthetic.

Individual motif designs are also available to help customise and enhance the ambience of any space.

Choose from any of the following solutions - AMF THERMATEX® Varioline Motif, Varioline Metal, Varioline Wood, Varioline Symetra and Varioline Colour to meet the acoustic, aesthetic and fire performance needs of your project.



Varioline Motif

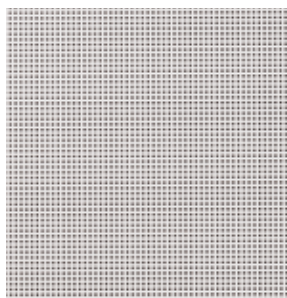

Varioline Metal



Varioline Wood

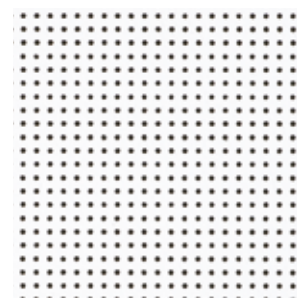

Varioline Symetra



# Smooth White Acoustic

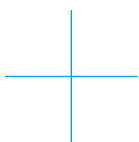

THE SMOOTH WHITE ACOUSTIC RANGE HAS THE WIDEST CHOICE OF EDGES, MODULES AND ACOUSTIC OPTIONS.

Designed to provide flexibility and complete noise control for every space – whether it's high sound absorption, high sound attenuation or a balance of both. Thanks to the smooth white surface, these aesthetically pleasing ceilings also offer high levels of light reflectance and energy saving benefits.





## DATASHEET

# AMF THERMATEX<sup>®</sup> Acoustic



- The laminated finish of AMF THERMATEX<sup>®</sup> Acoustic creates a smooth, white appearance and provides good levels of sound absorption and excellent sound attenuation
- Good sound absorption (0.65 (H)  $\alpha_w$ )
- Excellent sound attenuation (40 dB; SL2)

- High sound attenuation (38 dB; Board, Tegular 24/90, Tegular 15/90, Vector, Finesse)
- Excellent light reflectance (88%)
- ISO 4
- Ideal for retail, offices and meeting rooms, installation rooms or production areas

DATASHEET

AMF THERMATEX® Acoustic

<b>Edge details</b> Additional edge details on request		Board 	Tegular 24/90 	Tegular 15/90 	SL2 	Vector 	Finesse 	
<b>Thickness (mm)</b>		19	19	19	19	24	19	
<b>Dimensions (mm)</b>		600 x 600 625 x 625 1200 x 600 1250 x 625	600 x 600 625 x 625 1200 x 600	600 x 600 1200 x 600	1200 x 300 1500 x 300 1800 x 300 2000 x 300 2500 x 300	600 x 600 625 x 625 1200 x 600	600 x 600 625 x 625 1200 x 600 1250 x 625	
<b>System</b>		Exposed demountable - System C			Semi-concealed planks, demountable - System I.3 Semi-concealed planks - Bandraster, demountable - System I.2 Semi-concealed planks - Corridor, demountable - System F.2	Semi-concealed tiles, demountable - System C	Concealed, demountable - System A.2 / A.3	
<b>Weight</b>		5.0 - 8.6 kg / m <sup>2</sup>						
<b>Colour</b>		 White						
<b>Sound absorption</b>		EN ISO 354 <span style="float: right;"><math>\alpha_w = 0.65</math> (H) as per EN ISO 11654 - <b>Class C</b></span>						
		Frequency f (Hz)	125	250	500	1000	2000	4000
		$\alpha_p$ Board, Tegular 24/90, Tegular 15/90, Finesse, SL2	0.50	0.45	0.60	0.85	0.95	0.95
		$\alpha_p$ Vector	0.45	0.40	0.60	0.80	0.90	1.00
		NRC = <b>0.70</b> as per ASTM C 423						
<b>Sound attenuation</b>		EN ISO 10848-2 $D_{n,f,w} = 38$ dB (Board, Tegular 24/90, Tegular 15/90, Vector, Finesse) as per EN ISO 717-1 $D_{n,f,w} = 40$ dB (SL2) as per EN ISO 717-1						
		CAC = <b>39</b> dB (Board, Tegular 24/90, Tegular 15/90, Vector, Finesse) as per ASTM E 413-10						
<b>Sound reduction</b>		EN ISO 10140-2 $R_w = 22$ dB as per EN ISO 717-1						
<b>Fire reaction</b>		Euroclass <b>A2-s1, d0</b> as per EN 13501-1 <b>Class A</b> as per ASTM E 84						
<b>Light reflectance</b>		<b>88%</b>						
<b>Thermal conductivity</b>		$\lambda = 0.060$ W/mk as per EN 12667						
<b>Air permeability</b>		<b>PM1</b> ( $\leq 30$ m <sup>3</sup> /hm <sup>2</sup> ) as per DIN 18177						
<b>Humidity resistance</b>		<b>95% RH</b>						
<b>Clean room</b>		<b>ISO 4</b> as per EN ISO 14644-1						
<b>Indoor air quality</b>		 A+	 E1					
<b>Cleanability</b>								
<b>Sustainability</b>		 EN ISO 14021	 EN ISO 14025	 EC 1272/2008 Annex Q	 BRONZE			
		35 - 36.9%						

Products may vary from country to country.  
Please contact your local sales representative.  
For further information and legal notice, please visit our website.





## DATASHEET

# AMF THERMATEX<sup>®</sup> dB Acoustic



- AMF THERMATEX<sup>®</sup> dB Acoustic is the ideal solution for spaces requiring excellent sound attenuation and good sound absorption. It provides a simple yet timeless design finish to any space
- Good sound absorption (0.65 (H)  $\alpha_w$ )
- Excellent sound attenuation (24mm thickness: 41 dB - 30mm thickness: 43dB)
- Excellent light reflectance (88%)
- ISO 4
- Ideal for offices, meeting rooms and learning applications or corridors

DATASHEET

# AMF THERMATEX® dB Acoustic

<b>Edge details</b> Additional edge details on request		Board 	Tegular 24/90 	Tegular 15/90 																					
<b>Thickness (mm)</b>		24, 30	24	24																					
<b>Dimensions (mm)</b>		600 x 600	600 x 600	600 x 600																					
<b>System</b>		Exposed demountable - System C																							
<b>Weight</b>		8.6 - 10.6 kg / m <sup>2</sup>																							
<b>Colour</b>		 White																							
<b>Sound absorption</b>		<p>EN ISO 354 <span style="float: right;"><math>\alpha_w = \mathbf{0.65 (H)}</math> as per EN ISO 11654 - <b>Class C</b></span></p> <table border="1"> <thead> <tr> <th>Frequency f (Hz)</th> <th>125</th> <th>250</th> <th>500</th> <th>1000</th> <th>2000</th> <th>4000</th> </tr> </thead> <tbody> <tr> <td><math>\alpha_p</math> Board (24mm), Tegular 24/90, Tegular 15/90</td> <td>0.40</td> <td>0.45</td> <td>0.60</td> <td>0.80</td> <td>0.95</td> <td>0.95</td> </tr> <tr> <td><math>\alpha_p</math> Board (30mm)</td> <td>0.35</td> <td>0.40</td> <td>0.65</td> <td>0.85</td> <td>0.90</td> <td>0.95</td> </tr> </tbody> </table> <p>NRC = <b>0.70</b> as per ASTM C 423</p>			Frequency f (Hz)	125	250	500	1000	2000	4000	$\alpha_p$ Board (24mm), Tegular 24/90, Tegular 15/90	0.40	0.45	0.60	0.80	0.95	0.95	$\alpha_p$ Board (30mm)	0.35	0.40	0.65	0.85	0.90	0.95
Frequency f (Hz)	125	250	500	1000	2000	4000																			
$\alpha_p$ Board (24mm), Tegular 24/90, Tegular 15/90	0.40	0.45	0.60	0.80	0.95	0.95																			
$\alpha_p$ Board (30mm)	0.35	0.40	0.65	0.85	0.90	0.95																			
<b>Sound attenuation</b>		<p>EN ISO 10848-2 <span style="float: right;"><math>D_{n,f,w} = \mathbf{43 dB}</math> (30mm) as per EN ISO 717-1</span></p> <p><math>D_{n,f,w} = \mathbf{41 dB}</math> (24mm) as per EN ISO 717-1 <span style="float: right;"><math>D_{n,f,w} = \mathbf{43 dB}</math> (30mm) as per EN ISO 717-1</span></p> <p>CAC = <b>43 dB</b> (24mm) as per ASTM E 413-10</p>																							
<b>Sound reduction</b>		<p>EN ISO 10140-2 <span style="float: right;"><math>R_w = \mathbf{25 dB}</math> (30mm) as per EN ISO 717-1</span></p> <p><math>R_w = \mathbf{24 dB}</math> (24mm) as per EN ISO 717-1 <span style="float: right;"><math>R_w = \mathbf{25 dB}</math> (30mm) as per EN ISO 717-1</span></p>																							
<b>Fire reaction</b>		Euroclass <b>A2-s1, d0</b> as per EN 13501-1 <b>Class A</b> as per ASTM E 84																							
<b>Light reflectance</b>		<b>88%</b>																							
<b>Thermal conductivity</b>		$\lambda = \mathbf{0.075 W/mk}$ as per EN 12667																							
<b>Air permeability</b>		<b>PM1</b> ( $\leq 30 \text{ m}^3/\text{hm}^2$ ) as per DIN 18177																							
<b>Humidity resistance</b>		<b>95% RH</b>																							
<b>Clean room</b>		<b>ISO 4</b> as per EN ISO 14644-1																							
<b>Indoor air quality</b>		 A+	 E1																						
<b>Cleanability</b>																									
<b>Sustainability</b>		 36.9 - 37%	 EN ISO 14025	 EC 1272/2008 Annex Q																					
			 M1	 <a href="http://www.blauer-engel.de/uz132">www.blauer-engel.de/uz132</a>																					

Products may vary from country to country.  
Please contact your local sales representative.  
For further information and legal notice, please visit our website.



## DATASHEET

# AMF THERMATEX® Alpha HD 19mm

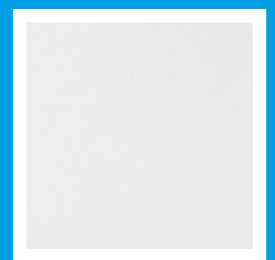

- AMF THERMATEX® Alpha HD 19mm offers a modern, white appearance and is the optimal solution for spaces that need a combination of excellent sound absorption and good sound attenuation
- Excellent sound absorption (0.90 a<sub>w</sub>)
- Good sound attenuation (34 dB)
- Excellent light reflectance (88%)
- ISO 4
- Ideal for offices, classrooms, learning applications and corridors

DATASHEET

# AMF THERMATEX® Alpha HD 19mm

Edge details Additional edge details on request		Board	Tegular 24/90	Tegular 15/90	SL2	Finesse		
Thickness (mm)		19	19	19	19	19		
Dimensions (mm)		600 x 600 625 x 625 675 x 675 1200 x 300 1200 x 600 1250 x 625 1500 x 600 1800 x 600	600 x 600 625 x 625 675 x 675 1200 x 300 1200 x 600 1250 x 625 1500 x 600 1800 x 600	600 x 600 625 x 625 675 x 675 1200 x 300 1200 x 600 1250 x 625 1350 x 300 1350 x 600 1500 x 600 1800 x 600	1350 x 300 1350 x 600 1500 x 300 1800 x 300 2000 x 300	600 x 600 625 x 625 1200 x 600 1250 x 625		
System		Exposed demountable - System C		Exposed, demountable - System C Exposed - Bandraster, demountable - System I.3 Exposed - Corridor, demountable - System F.3	Semi-concealed planks, demountable - System I.3 Semi-concealed planks - Bandraster, demountable - System I.2 Semi-concealed planks - Corridor, demountable - System F.2	Concealed, demountable - System A.2 / A.3		
Weight		5.2 kg / m²						
Colour		 White						
Sound absorption		EN ISO 354 $\alpha_w = \mathbf{0.90}$ as per EN ISO 11654 - <b>Class A</b>						
		Frequency $f$ (Hz)	125	250	500	1000	2000	4000
		$\alpha_p$	0.50	0.70	0.80	0.90	1.00	1.00
		NRC = <b>0.85</b> as per ASTM C 423						
Sound attenuation		EN ISO 10848-2						
		$D_{n,f,w} = \mathbf{34 dB}$ as per EN ISO 717-1				CAC = <b>35 dB</b> as per ASTM E 413-10		
Sound reduction		EN ISO 10140-2 $R_w = \mathbf{17 dB}$ as per EN ISO 717-1						
Fire reaction		Euroclass <b>A2-s1, d0</b> as per EN 13501-1						
Light reflectance		<b>88%</b>						
Thermal conductivity		$\lambda = \mathbf{0.060 W/mk}$ as per EN 12667						
Air permeability		<b>PM1</b> ( $\leq 30 m^3/hm^2$ ) as per DIN 18177						
Humidity resistance		<b>95% RH</b>						
Clean room		<b>ISO 4</b> as per EN ISO 14644-1						
Indoor air quality								
		A+	E1					
Cleanability								
Sustainability								
		49.1%	EN ISO 14025	EC 1272/2008 Annex Q				<a href="http://www.blauer-engel.de/uz132">www.blauer-engel.de/uz132</a>

Products may vary from country to country.  
Please contact your local sales representative.  
For further information and legal notice, please visit our website.





## DATASHEET

# AMF THERMATEX® Alpha HD 30mm



- AMF THERMATEX® Alpha HD 30mm offers a modern, white appearance and is the optimal solution for spaces that need excellent sound absorption and sound attenuation
- Excellent sound absorption (0.90  $\alpha_w$ )
- Excellent sound attenuation (40 dB)

- Excellent light reflectance (88%)
- ISO 4
- Ideal for offices, classrooms and learning applications

DATASHEET

# AMF THERMATEX® Alpha HD 30mm

<b>Edge details</b> Additional edge details on request		Board 	Tegular 24/90 	Tegular 15/90 	SL2 	Finesse 		
<b>Thickness (mm)</b>		30	30	30	30	30		
<b>Dimensions (mm)</b>		600 x 600 625 x 625 675 x 675 1200 x 600 1250 x 625	600 x 600 625 x 625 675 x 675 1200 x 600 1250 x 625	600 x 600 625 x 625 675 x 675 1200 x 600 1250 x 625 1350 x 300 1350 x 600	1350 x 300 1350 x 600 1500 x 300 1800 x 300 2000 x 300	600 x 600 625 x 625 1200 x 600 1250 x 625		
<b>System</b>		Exposed demountable - System C	Exposed, demountable - System C Exposed - Bandraster, demountable - System I.3 Exposed - Corridor, demountable - System F.3	Exposed, demountable - System C Exposed - Bandraster, demountable - System I.3 Exposed - Corridor, demountable - System F.3	Semi-concealed planks, demountable - System I.3 Semi-concealed planks - Bandraster, demountable - System I.2 Semi-concealed planks - Corridor, demountable - System F.2	Concealed, demountable - System A.2 / A.3		
<b>Weight</b>		8.2 kg / m <sup>2</sup>						
<b>Colour</b>		 White						
<b>Sound absorption</b>		EN ISO 354 <span style="float: right;"><math>\alpha_w = 0.90</math> as per EN ISO 11654 - <b>Class A</b></span>						
		Frequency f (Hz)	125	250	500	1000	2000	4000
		$\alpha_p$	0.55	0.70	0.85	1.00	1.00	1.00
		NRC = <b>0.90</b> as per ASTM C 423						
<b>Sound attenuation</b>		EN ISO 10848-2 $D_{n,f,w} = 40$ dB as per EN ISO 717-1 <span style="float: right;">CAC = <b>41</b> dB as per ASTM E 413-10</span>						
<b>Sound reduction</b>		EN ISO 10140-2 $R_w = 22$ dB as per EN ISO 717-1						
<b>Fire reaction</b>		Euroclass <b>A2-s1, d0</b> as per EN 13501-1						
<b>Light reflectance</b>		<b>88%</b>						
<b>Thermal conductivity</b>		$\lambda = 0.060$ W/mk as per EN 12667						
<b>Air permeability</b>		<b>PM1</b> ( $\leq 30$ m <sup>3</sup> /hm <sup>2</sup> ) as per DIN 18177						
<b>Humidity resistance</b>		<b>95% RH</b>						
<b>Clean room</b>		<b>ISO 4</b> as per EN ISO 14644-1						
<b>Indoor air quality</b>		 A+	 E1					
<b>Cleanability</b>								
<b>Sustainability</b>		 49.9%		 EC 1272/2008 Annex G				<a href="http://www.blauer-engel.de/uz132">www.blauer-engel.de/uz132</a>

Products may vary from country to country.  
Please contact your local sales representative.  
For further information and legal notice, please visit our website.



© Victor Sajara Photography

## DATASHEET

# AMF THERMATEX® Alpha HD 35mm



- AMF THERMATEX® Alpha HD 35mm offers a modern, white appearance and is the optimal solution for spaces that need excellent sound absorption and sound attenuation
- Excellent sound absorption ( $0.90 \alpha_w$ )

- Excellent sound attenuation (42 dB)
- Excellent light reflectance (88%)
- ISO 4
- Ideal for offices, classrooms and learning applications

DATASHEET

AMF THERMATEX® Alpha HD 35mm

<b>Edge details</b> Additional edge details on request		Board 	Tegular 24/90 	Tegular 15/90 	SL2 														
<b>Thickness (mm)</b>		35	35	35	35														
<b>Dimensions (mm)</b>		600 x 600 625 x 625 1200 x 600 1250 x 625	600 x 600 625 x 625 1200 x 600 1250 x 625	600 x 600 625 x 625 1200 x 600 1250 x 625 1350 x 300 1350 x 600	1350 x 300 1350 x 600 1500 x 300 1800 x 300 2000 x 300														
<b>System</b>		Exposed demountable - System C		Exposed, demountable - System C Exposed - Bandraster, demountable - System I.3 Exposed - Corridor, demountable - System F.3		Semi-concealed planks, demountable - System I.3 Semi-concealed planks - Bandraster, demountable - System I.2 Semi-concealed planks - Corridor, demountable - System F.2													
<b>Weight</b>		9.5 kg / m <sup>2</sup>																	
<b>Colour</b>		 White																	
<b>Sound absorption</b>		EN ISO 354 <span style="float: right;"><math>\alpha_w = 0.90</math> as per EN ISO 11654 - <b>Class A</b></span> Frequency <i>f</i> (Hz) <table border="1" style="display: inline-table; vertical-align: middle;"><tr><td>125</td><td>250</td><td>500</td><td>1000</td><td>2000</td><td>4000</td></tr></table> $\alpha_p$ <table border="1" style="display: inline-table; vertical-align: middle;"><tr><td>0.40</td><td>0.65</td><td>0.85</td><td>1.00</td><td>1.00</td><td>1.00</td></tr></table> NRC = <b>0.85</b> as per ASTM C 423						125	250	500	1000	2000	4000	0.40	0.65	0.85	1.00	1.00	1.00
125	250	500	1000	2000	4000														
0.40	0.65	0.85	1.00	1.00	1.00														
<b>Sound attenuation</b>		EN ISO 10848-2 $D_{n,f,w} = 42$ dB as per EN ISO 717-1 <span style="float: right;">CAC = <b>44</b> dB as per ASTM E 413-10</span>																	
<b>Sound reduction</b>		EN ISO 10140-2 $R_w = 25$ dB as per EN ISO 717-1																	
<b>Fire reaction</b>		Euroclass <b>A2-s1, d0</b> as per EN 13501-1																	
<b>Light reflectance</b>		<b>88%</b>																	
<b>Thermal conductivity</b>		$\lambda = 0.060$ W/mk as per EN 12667																	
<b>Air permeability</b>		<b>PM1</b> ( $\leq 30$ m <sup>3</sup> /hm <sup>2</sup> ) as per DIN 18177																	
<b>Humidity resistance</b>		<b>95% RH</b>																	
<b>Clean room</b>		<b>ISO 4</b> as per EN ISO 14644-1																	
<b>Indoor air quality</b>		 A+	 E1																
<b>Cleanability</b>																			
<b>Sustainability</b>		 50.4%		 EC 1272/2008 Annex G															

Products may vary from country to country.  
Please contact your local sales representative.  
For further information and legal notice, please visit our website.





## DATASHEET

# AMF THERMATEX<sup>®</sup> Alpha One



- AMF THERMATEX<sup>®</sup> Alpha One offers a modern, white appearance and is the optimal solution for spaces that need excellent sound absorption
- Excellent sound absorption (1.00  $\alpha_w$ )
- Excellent light reflectance (88%)
- ISO 4
- Ideal for offices, classrooms and learning applications

DATASHEET

# AMF THERMATEX® Alpha One

<b>Edge details</b> Additional edge details on request		Board 	Tegular 24/90 	Tegular 15/90 				
<b>Thickness (mm)</b>		24	24	24				
<b>Dimensions (mm)</b>		600 x 600 625 x 625 1200 x 600	600 x 600 625 x 625 1200 x 600	600 x 600 625 x 625 1200 x 600				
<b>System</b>		Exposed demountable - System C						
<b>Weight</b>		4.0 kg / m <sup>2</sup>						
<b>Colour</b>		 White						
<b>Sound absorption</b>		EN ISO 354 <span style="float: right;"><math>\alpha_w = 1.00</math> as per EN ISO 11654 - <b>Class A</b></span>						
		Frequency <i>f</i> (Hz)	125	250	500	1000	2000	4000
		$\alpha_p$	0.55	0.85	1.00	0.95	1.00	1.00
		NRC = <b>1.00</b> as per ASTM C 423						
<b>Sound attenuation</b>		EN ISO 10848-2 $D_{n,f,w} = 29$ dB as per EN ISO 717-1						
<b>Sound reduction</b>		EN ISO 10140-2 $R_w = 17$ dB as per EN ISO 717-1						
<b>Fire reaction</b>		Euroclass <b>A2-s1, d0</b> as per EN 13501-1 <b>Class A</b> as per ASTM E 84						
<b>Light reflectance</b>		<b>88%</b>						
<b>Thermal conductivity</b>		$\lambda = 0.040$ W/mk as per EN 12667						
<b>Air permeability</b>		<b>PM1</b> ( $\leq 30$ m <sup>3</sup> /hm <sup>2</sup> ) as per DIN 18177						
<b>Humidity resistance</b>		<b>95% RH</b>						
<b>Clean room</b>		<b>ISO 4</b> as per EN ISO 14644-1						
<b>Indoor air quality</b>		 A+	 E1					
<b>Cleanability</b>								
<b>Sustainability</b>		 50.8%		 EC 1272/2008 Annex Q	 MATERIALS EMISSION CLASS FOR BUILDING			<a href="http://www.blauer-engel.de/uz132">www.blauer-engel.de/uz132</a>

Products may vary from country to country.  
Please contact your local sales representative.  
For further information and legal notice, please visit our website.



# AMF THERMATEX® Alpha

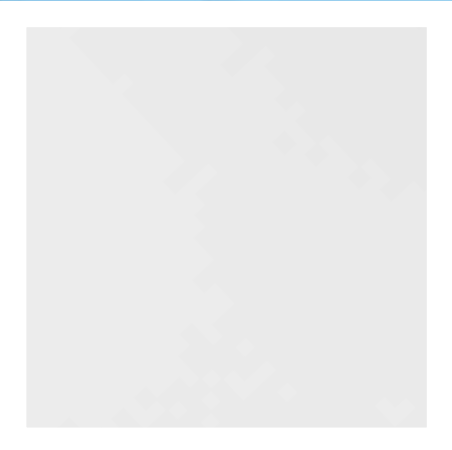

- AMF THERMATEX® Alpha offers a modern, white appearance and is the optimal solution for spaces that need excellent sound absorption
- Excellent sound absorption (0.95  $\alpha_w$ )
- Excellent light reflectance (88%)
- ISO 4
- Ideal for offices, classrooms and learning applications



# AMF THERMATEX® ALPHA

<b>Edge details</b> Additional edge details on request		Board 	Tegular 24/90 	Tegular 15/90 														
<b>Thickness (mm)</b>		19	19	19														
<b>Dimensions (mm)</b> Additional sizes on request		600 x 600 625 x 625 1200 x 600 1250 x 625	600 x 600 625 x 625 1200 x 600	600 x 600 625 x 625 1200 x 600														
<b>System</b>		Exposed demountable - System C																
<b>Weight</b>		3.3 kg / m <sup>2</sup>																
<b>Colour</b>		White																
<b>Sound absorption</b>		EN ISO 354 $\alpha_w = 0.95$ as per EN ISO 11654 - <b>Class A</b> <table border="1"> <thead> <tr> <th>Frequency f (Hz)</th> <th>125</th> <th>250</th> <th>500</th> <th>1000</th> <th>2000</th> <th>4000</th> </tr> </thead> <tbody> <tr> <td><math>\alpha_p</math></td> <td>0.50</td> <td>0.80</td> <td>0.90</td> <td>0.90</td> <td>1.00</td> <td>1.00</td> </tr> </tbody> </table> NRC = <b>0.90</b> as per ASTM C 423			Frequency f (Hz)	125	250	500	1000	2000	4000	$\alpha_p$	0.50	0.80	0.90	0.90	1.00	1.00
Frequency f (Hz)	125	250	500	1000	2000	4000												
$\alpha_p$	0.50	0.80	0.90	0.90	1.00	1.00												
<b>Sound attenuation</b>		EN ISO 10848-2 $D_{n,f,w} = 28 \text{ dB}$ as per EN ISO 717-1 $D_{n,f,w} = 29 \text{ dB}$ as per ASTM E 413-10																
<b>Sound reduction</b>		EN ISO 10140-2 $R_w = 14 \text{ dB}$ as per EN ISO 717-1																
<b>Fire reaction</b>		Euroclass <b>A2-s1, d0</b> as per EN 13501-1 <b>Class A</b> as per ASTM E 84 RUS <b>KM1 (G1, V1, D1, T1)</b> as per 123-FZ																
<b>Light reflectance</b>		<b>88%</b>																
<b>Thermal conductivity</b>		$\lambda = 0.040 \text{ W/mk}$ as per EN 12667																
<b>Air permeability</b>		<b>PM1</b> ( $\leq 30 \text{ m}^3/\text{hm}^2$ ) as per DIN 18177																
<b>Humidity resistance</b>		<b>95% RH</b>																
<b>Clean room</b>		<b>ISO 4</b> as per EN ISO 14644-1																
<b>Indoor air quality</b>		 A+	 E1	 IACG														
<b>Cleanability</b>		 																
<b>Sustainability</b>		 EN ISO 14021 43%	 EPD EN ISO 14025	 BIOSOLUBLE WOOL EC 1272/2008 Annex G														
			 M1 EMISSION CLASS FOR BUILDING MATERIALS	 BLUE ANGEL THE GREEN LABEL <a href="http://www.blauer-engel.de/uz132">www.blauer-engel.de/uz132</a>														

Products may vary from country to country.  
 Please contact your local sales representative.  
 For further information and legal notice, please visit our website.





## ARMSTRONG PERLA



- Armstrong PERLA is a C2C Bronze certified range with a smooth laminated finish providing balanced acoustic performance of both sound absorption and sound attenuation
- Good sound absorption (0.65(H)  $\alpha_w$ ) and sound attenuation (36 dB)
- Excellent light reflectance (88%)
- ISO 5
- Ideal for office and learning applications



# ARMSTRONG PERLA

<b>Edge details</b> Additional edge details on request	 Board 	Regular 24 	Regular 15/90 														
<b>Thickness (mm)</b>	 17	17	17														
<b>Dimensions (mm)</b> Additional sizes on request	 600 x 600	600 x 600	600 x 600														
<b>System</b>	 Exposed demountable - System C																
<b>Weight</b>	 4.6 kg / m <sup>2</sup>																
<b>Colour</b>	 White																
<b>Sound absorption</b>	 EN ISO 354 $\alpha_w = \mathbf{0.65(H)}$ as per EN ISO 11654 - <b>Class C</b> <table border="1" data-bbox="464 875 1453 954"> <thead> <tr> <th>Frequency f (Hz)</th> <th>125</th> <th>250</th> <th>500</th> <th>1000</th> <th>2000</th> <th>4000</th> </tr> </thead> <tbody> <tr> <td><math>\alpha_p</math></td> <td>0.40</td> <td>0.45</td> <td>0.60</td> <td>0.80</td> <td>0.90</td> <td>0.90</td> </tr> </tbody> </table> NRC = <b>0.70</b> as per ASTM C 423			Frequency f (Hz)	125	250	500	1000	2000	4000	$\alpha_p$	0.40	0.45	0.60	0.80	0.90	0.90
Frequency f (Hz)	125	250	500	1000	2000	4000											
$\alpha_p$	0.40	0.45	0.60	0.80	0.90	0.90											
<b>Sound attenuation</b>	 EN ISO 10848-2 $D_{n,f,w} = \mathbf{36 dB}$ as per EN ISO 717-1 CAC = <b>37 dB</b> as per ASTM E 413-10																
<b>Sound reduction</b>	 EN ISO 10140-2 $R_w = \mathbf{18 dB}$ as per EN ISO 717-1																
<b>Fire reaction</b>	 Euroclass <b>A2-s1, d0</b> as per EN 13501-1 RUS <b>KM1 (G1, V1, D1, T1)</b> as per 123-FZ																
<b>Light reflectance</b>	 <b>88%</b>																
<b>Thermal conductivity</b>	 $\lambda = \mathbf{0.060 W/mk}$ as per EN 12667																
<b>Air permeability</b>	 <b>PM1 (<math>\leq 30 \text{ m}^3/\text{hm}^2</math>)</b> as per DIN 18177																
<b>Humidity resistance</b>	 <b>95% RH</b>																
<b>Clean room</b>	 <b>ISO 5</b> as per EN ISO 14644-1																
<b>Indoor air quality</b>	  A+  E1  IACG																
<b>Cleanability</b>	  																
<b>Sustainability</b>	 EN ISO 14021  EPD EN ISO 14025  MOODLE WOOD EC 1272/2008 Annex C  M1  BLUE ANGEL <a href="http://www.blauer-engel.de/uz132">www.blauer-engel.de/uz132</a>  CRADLE TO CRADLE BRONZE 39 - 41%																

Products may vary from country to country.  
 Please contact your local sales representative.  
 For further information and legal notice, please visit our website.



## ARMSTRONG PERLA dB



- Armstrong PERLA dB is a C2C Bronze certified range with a smooth laminated finish providing enhanced sound attenuation performance for improving the privacy between adjacent spaces
- Good sound absorption (0.60(H)  $\alpha_w$ )
- Excellent light reflectance (88%)
- ISO 5
- Ideal for individual offices





# ARMSTRONG PERLA dB

<b>Edge details</b> Additional edge details on request		Board 	Tegular 24 	Tegular 15/90 														
<b>Thickness (mm)</b>		19	19	19														
<b>Dimensions (mm)</b> Additional sizes on request		600 x 600	600 x 600	600 x 600														
<b>System</b>		Exposed demountable - System C																
<b>Weight</b>		8.1 kg / m <sup>2</sup>																
<b>Colour</b>		White																
<b>Sound absorption</b>		EN ISO 354 $\alpha_w = \mathbf{0.60(H)}$ as per EN ISO 11654 - <b>Class C</b> <table border="1"> <thead> <tr> <th>Frequency f (Hz)</th> <th>125</th> <th>250</th> <th>500</th> <th>1000</th> <th>2000</th> <th>4000</th> </tr> </thead> <tbody> <tr> <td><math>\alpha_p</math></td> <td>0.40</td> <td>0.40</td> <td>0.55</td> <td>0.75</td> <td>0.85</td> <td>0.95</td> </tr> </tbody> </table> NRC = <b>0.65</b> as per ASTM C 423			Frequency f (Hz)	125	250	500	1000	2000	4000	$\alpha_p$	0.40	0.40	0.55	0.75	0.85	0.95
Frequency f (Hz)	125	250	500	1000	2000	4000												
$\alpha_p$	0.40	0.40	0.55	0.75	0.85	0.95												
<b>Sound attenuation</b>		EN ISO 10848-2 $D_{n,f,w} = \mathbf{41 dB}$ as per EN ISO 717-1 CAC = <b>42 dB</b> as per ASTM E 413-10																
<b>Sound reduction</b>		EN ISO 10140-2 $R_w = \mathbf{21 dB}$ as per EN ISO 717-1																
<b>Fire reaction</b>		Euroclass <b>A2-s1, d0</b> as per EN 13501-1 RUS <b>KM1 (G1, V1, D1, T1)</b> as per 123-FZ																
<b>Light reflectance</b>		<b>88%</b>																
<b>Thermal conductivity</b>		$\lambda = \mathbf{0.075 W/mk}$ as per EN 12667																
<b>Air permeability</b>		<b>PM1 (<math>\leq 30 m^3/hm^2</math>)</b> as per DIN 18177																
<b>Humidity resistance</b>		<b>95% RH</b>																
<b>Clean room</b>		<b>ISO 5</b> as per EN ISO 14644-1																
<b>Indoor air quality</b>		 A+	 E1	 IACG														
<b>Cleanability</b>																		
<b>Sustainability</b>		 EN ISO 14021 39%	 EN ISO 14025	 IC 1272/2008 Annex C  M1  ULITE AMDEI  cradle to cradle BRONZE <a href="http://www.blauer-engel.de/uz132">www.blauer-engel.de/uz132</a>														

Products may vary from country to country.  
 Please contact your local sales representative.  
 For further information and legal notice, please visit our website.





## ARMSTRONG PERLA OP 0.95

- Armstrong PERLA OP 0.95 is a Cradle to Cradle Certified® Bronze range with a smooth laminated finish and excellent Class A sound absorption, making it ideal for open plan areas
- Excellent sound absorption (0.95  $\alpha_w$ )
- PERLA OP 19mm planks are available, see separate datasheet
- Good light reflectance (85%)
- ISO 5
- Ideal for open spaces (call centres, libraries, cafeterias, etc.)



# ARMSTRONG PERLA OP 0.95

<b>Edge details</b> Additional edge details on request	 Board 	Tegular 24 	Tegular 15/90 														
<b>Thickness (mm)</b>	 15	15	15														
<b>Dimensions (mm)</b> Additional sizes on request	 600 x 600 675 x 675 1200 x 600	600 x 600 675 x 675 1200 x 600	600 x 600 675 x 675 1200 x 600														
<b>System</b>	 Exposed demountable - System C																
<b>Weight</b>	 2.4 - 2.6 kg/m <sup>2</sup>																
<b>Colour</b>	 White																
<b>Sound absorption</b>	 EN ISO 354 $\alpha_w = 0.95$ as per EN ISO 11654 - <b>Class A</b> <table border="1" data-bbox="467 913 1452 992"> <thead> <tr> <th>Frequency f (Hz)</th> <th>125</th> <th>250</th> <th>500</th> <th>1000</th> <th>2000</th> <th>4000</th> </tr> </thead> <tbody> <tr> <td><math>\alpha_p</math> Board, Tegular</td> <td>0.45</td> <td>0.80</td> <td>0.95</td> <td>0.90</td> <td>1.00</td> <td>1.00</td> </tr> </tbody> </table> NRC = <b>0.90</b> as per ASTM C 423			Frequency f (Hz)	125	250	500	1000	2000	4000	$\alpha_p$ Board, Tegular	0.45	0.80	0.95	0.90	1.00	1.00
Frequency f (Hz)	125	250	500	1000	2000	4000											
$\alpha_p$ Board, Tegular	0.45	0.80	0.95	0.90	1.00	1.00											
<b>Sound attenuation</b>	 EN ISO 10848-2 $D_{n,f,w} = 25$ dB as per EN ISO 717-1 CAC = <b>25 dB</b> as per ASTM E 413-10																
<b>Sound reduction</b>	 EN ISO 10140-2 $R_w = 12$ dB as per EN ISO 717-1																
<b>Fire reaction</b>	 Euroclass <b>A2-s1, d0</b> as per EN 13501-1 <b>Class A</b> as per ASTM E 84 RUS <b>KM1 (G1, V1, D1, T1)</b> as per 123-FZ																
<b>Light reflectance</b>	 <b>85%</b>																
<b>Thermal conductivity</b>	 $\lambda = 0.040$ W/mk as per EN 12667																
<b>Humidity resistance</b>	 <b>95% RH</b>																
<b>Clean room</b>	 <b>ISO 5</b> as per EN ISO 14644-1																
<b>Indoor air quality</b>	 <table border="0" data-bbox="467 1597 818 1709"> <tr> <td></td> <td></td> <td></td> </tr> <tr> <td>A+</td> <td>E1</td> <td>IACG</td> </tr> </table>						A+	E1	IACG								
																	
A+	E1	IACG															
<b>Cleanability</b>	  																
<b>Sustainability</b>	    44 - 66%																

Products may vary from country to country.  
 Please contact your local sales representative.  
 For further information and legal notice, please visit our website.



## ARMSTRONG PERLA OP 19mm

- Armstrong PERLA OP 19mm Planks provide a smooth white laminated finish, and with excellent Class A sound absorption and good sound attenuation, they are the ideal solution for both open plan and corridor applications
- Excellent sound absorption (0.90  $\alpha_w$ ) and good sound attenuation (34 dB)
- Good light reflectance (85%)
- ISO 5
- Ideal for open spaces (call centres, libraries, cafeterias, etc.) as well as corridors



# ARMSTRONG PERLA OP 19mm

<b>Edge details</b> Additional edge details on request	 Board 	SL2 														
<b>Thickness (mm)</b>	 19	19														
<b>Dimensions (mm)</b> Additional sizes on request	 1500 x 600 1800 x 600	1500 x 300 1800 x 300														
<b>System</b>	 Exposed demountable - System C Exposed - Bandraster, demountable - System I.3 Exposed - Corridor, demountable - System F.3	Semi-concealed planks, demountable - System I.3 Semi-concealed planks - Bandraster, demountable - System I.2 Semi-concealed planks - Corridor, demountable - System F.2														
<b>Weight</b>	 5.2 kg / m <sup>2</sup>															
<b>Colour</b>	 White															
<b>Sound absorption</b>	 EN ISO 354 $\alpha_w = 0.90$ as per EN ISO 11654 - <b>Class A</b> <table border="1" data-bbox="467 927 1453 1010"> <thead> <tr> <th>Frequency f (Hz)</th> <th>125</th> <th>250</th> <th>500</th> <th>1000</th> <th>2000</th> <th>4000</th> </tr> </thead> <tbody> <tr> <td><math>\alpha_p</math></td> <td>0.45</td> <td>0.70</td> <td>0.80</td> <td>0.90</td> <td>1.00</td> <td>1.00</td> </tr> </tbody> </table> NRC = <b>0.85</b> as per ASTM C 423		Frequency f (Hz)	125	250	500	1000	2000	4000	$\alpha_p$	0.45	0.70	0.80	0.90	1.00	1.00
Frequency f (Hz)	125	250	500	1000	2000	4000										
$\alpha_p$	0.45	0.70	0.80	0.90	1.00	1.00										
<b>Sound attenuation</b>	 EN ISO 10848-2 $D_{n,f,w} = 34$ dB as per EN ISO 717-1 CAC = <b>35 dB</b> as per ASTM E 413-10															
<b>Fire reaction</b>	 Euroclass <b>A2-s1, d0</b> as per EN 13501-1 RUS <b>KM1 (G1, V1, D1, T1)</b> as per 123-FZ															
<b>Light reflectance</b>	 <b>85%</b>															
<b>Thermal conductivity</b>	 $\lambda = 0.060$ W/mk as per EN 12667															
<b>Air permeability</b>	 <b>PM1 (<math>\leq 30</math> m<sup>3</sup>/hm<sup>2</sup>)</b> as per DIN 18177															
<b>Humidity resistance</b>	 <b>95% RH</b>															
<b>Clean room</b>	 <b>ISO 5</b> as per EN ISO 14644-1															
<b>Indoor air quality</b>	  A+  E1  IACG															
<b>Cleanability</b>	 															
<b>Sustainability</b>	 EN ISO 14021 38%  EN ISO 14025  INNOVATIVE WOOL ISO 272/2008 Annex G  M1 CLASS 100 BUILDING MATERIALS - EMISSION  BLUE ANGEL THE GERMAN ECOLABEL <a href="http://www.blauer-engel.de/uz132">www.blauer-engel.de/uz132</a>  cradle to cradle BRONZE															

Products may vary from country to country.  
 Please contact your local sales representative.  
 For further information and legal notice, please visit our website.













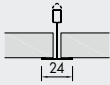
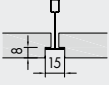

## ARMSTRONG PERLA OP 1.00

- Armstrong PERLA OP 1.00 is a C2C Bronze certified range with a smooth laminated finish and offers excellent sound absorption ( $1.00 \alpha_w$ ), making it ideal for open plan areas
- Excellent sound absorption ( $1.00 \alpha_w$ )
- Good light reflectance (85%)
- ISO 4
- Ideal for open spaces (call centres, libraries, cafeterias, etc.)



# ARMSTRONG PERLA OP 1.00

<b>Edge details</b> Additional edge details on request	 Board 	Tegular 24 	Tegular 15/90 														
<b>Thickness (mm)</b>	 20	20	20														
<b>Dimensions (mm)</b> Additional sizes on request	 600 x 600 675 x 675 1200 x 600	600 x 600 675 x 675 1200 x 600	600 x 600 675 x 675 1200 x 600														
<b>System</b>	 Exposed demountable - System C																
<b>Weight</b>	 3.1 kg / m <sup>2</sup>																
<b>Colour</b>	 White																
<b>Sound absorption</b>	 EN ISO 354 $\alpha_w = \mathbf{1.00}$ as per EN ISO 11654 - <b>Class A</b> <table border="1" data-bbox="459 875 1453 949"> <thead> <tr> <th>Frequency f (Hz)</th> <th>125</th> <th>250</th> <th>500</th> <th>1000</th> <th>2000</th> <th>4000</th> </tr> </thead> <tbody> <tr> <td><math>\alpha_p</math></td> <td>0.50</td> <td>0.85</td> <td>0.95</td> <td>0.95</td> <td>1.00</td> <td>1.00</td> </tr> </tbody> </table> NRC = <b>0.95</b> as per ASTM C 423			Frequency f (Hz)	125	250	500	1000	2000	4000	$\alpha_p$	0.50	0.85	0.95	0.95	1.00	1.00
Frequency f (Hz)	125	250	500	1000	2000	4000											
$\alpha_p$	0.50	0.85	0.95	0.95	1.00	1.00											
<b>Sound attenuation</b>	 EN ISO 10848-2 $D_{n,f,w} = \mathbf{25\ dB}$ as per EN ISO 717-1 CAC = <b>25 dB</b> as per ASTM E 413-10																
<b>Sound reduction</b>	 EN ISO 10140-2 $R_w = \mathbf{12\ dB}$ as per EN ISO 717-1																
<b>Fire reaction</b>	 Euroclass <b>A2-s1, d0</b> as per EN 13501-1 RUS <b>KM1 (G1, V1, D1, T1)</b> as per 123-FZ																
<b>Light reflectance</b>	 <b>85%</b>																
<b>Thermal conductivity</b>	 $\lambda = \mathbf{0.040\ W/mk}$ as per EN 12667																
<b>Humidity resistance</b>	 <b>95% RH</b>																
<b>Clean room</b>	 <b>ISO 4</b> as per EN ISO 14644-1																
<b>Indoor air quality</b>	 <div style="display: flex; justify-content: space-around; align-items: center;"> <div style="text-align: center;">   <b>A+</b> </div> <div style="text-align: center;">   <b>E1</b> </div> <div style="text-align: center;">   <b>IACG</b> </div> </div>																
<b>Cleanability</b>																	
<b>Sustainability</b>	 <div style="display: flex; justify-content: space-around; align-items: center;"> <div style="text-align: center;">   <b>73%</b> </div> <div style="text-align: center;">   <b>EN ISO 14025</b> </div> <div style="text-align: center;">   <b>Woolmark</b> </div> <div style="text-align: center;">   <b>cradle to cradle</b>  <b>BRONZE</b> </div> </div>																

Products may vary from country to country.  
 Please contact your local sales representative.  
 For further information and legal notice, please visit our website.



## DATASHEET

# Antaris



- Antaris is a white, laminated mineral tile and offers Class A sound absorption. Antaris provides fire protection and a hygienic ceiling solution
- Excellent sound absorption (0.90  $\alpha_w$ )
- High light reflectance (86%)
- ISO 5
- Ideal for retail, offices and meeting rooms, installation rooms or production areas

DATASHEET

Antaris

<b>Edge details</b> Additional edge details on request		Board 	Tegular 24/90 	Tegular 15/90 				
<b>Thickness (mm)</b>		15	15	15				
<b>Dimensions (mm)</b> Additional sizes on request		600 x 600 675 x 675 1200 x 600	600 x 600 675 x 675 1200 x 600	600 x 600 675 x 675 1200 x 600				
<b>System</b>		Exposed demountable - System C						
<b>Weight</b>		2.9 kg / m <sup>2</sup>						
<b>Colour</b>		 White						
<b>Sound absorption</b>		EN ISO 354 $\alpha_w = \mathbf{0.90}$ as per EN ISO 11654 - <b>Class A</b>						
		Frequency f (Hz)	125	250	500	1000	2000	4000
		$\alpha_p$	0.50	0.80	0.85	0.85	1.00	1.00
		NRC = <b>0.90</b> as per ASTM C 423						
<b>Sound attenuation</b>		EN ISO 10848-2 $D_{n,f,w} = \mathbf{28 dB}$ as per EN ISO 717-1		CAC = <b>29 dB</b> as per ASTM E 413-10				
<b>Sound reduction</b>		EN ISO 10140-2 $R_w = \mathbf{13 dB}$ as per EN ISO 717-1						
<b>Fire reaction</b>		Euroclass <b>A2-s1, d0</b> as per EN 13501-1 <b>Class A</b> as per ASTM E 84						
<b>Light reflectance</b>		<b>86%</b>						
<b>Thermal conductivity</b>		$\lambda = \mathbf{0.040 W/mk}$ as per EN 12667						
<b>Humidity resistance</b>		<b>95% RH</b>						
<b>Clean room</b>		<b>ISO 5</b> as per EN ISO 14644-1						
<b>Indoor air quality</b>		 A+	 E1					
<b>Cleanability</b>								
<b>Sustainability</b>		 43%		 EC 1272/2008 Annex Q				<a href="http://www.blauer-engel.de/uz132">www.blauer-engel.de/uz132</a>

Products may vary from country to country.  
Please contact your local sales representative.  
For further information and legal notice, please visit our website.





## DATASHEET

# Antaris C



- Antaris C tiles are made from a new generation biosoluble mineral wool, clay and starch and offers excellent fire resistance. The smooth, white laminate finish provides good levels of sound absorption for acoustic comfort
- Good sound absorption ( $0.70 \alpha_w$ )
- High light reflectance (86%)
- ISO 5
- Ideal for retail, offices and meeting rooms, installation rooms or production areas

# DATASHEET

## Antaris C

<b>Edge details</b> Additional edge details on request		Board 	Tegular 24 	Tegular 15 				
<b>Thickness (mm)</b>		13	13	13				
<b>Dimensions (mm)</b> Additional sizes on request		600 x 600 1200 x 600	600 x 600	600 x 600				
<b>System</b>		Exposed demountable - System C						
<b>Weight</b>		3.0 kg / m <sup>2</sup>						
<b>Colour</b>		 White						
<b>Sound absorption</b>		EN ISO 354 $\alpha_w = \mathbf{0.70}$ as per EN ISO 11654 - <b>Class C</b>						
		Frequency f (Hz)	125	250	500	1000	2000	4000
		$\alpha_p$	0.40	0.55	0.60	0.75	0.95	1.00
		NRC = <b>0.70</b> as per ASTM C 423						
<b>Sound attenuation</b>		EN ISO 10848-2 $D_{n,f,w} = \mathbf{30 dB}$ as per EN ISO 717-1			CAC = <b>30 dB</b> as per ASTM E 413-10			
<b>Sound reduction</b>		EN ISO 10140-2 $R_w = \mathbf{18 dB}$ as per EN ISO 717-1						
<b>Fire reaction</b>		Euroclass <b>A2-s1, d0</b> as per EN 13501-1						
<b>Light reflectance</b>		<b>86%</b>						
<b>Thermal conductivity</b>		$\lambda = \mathbf{0.060 W/mk}$ as per EN 12667						
<b>Humidity resistance</b>		<b>90% RH</b>						
<b>Clean room</b>		<b>ISO 5</b> as per EN ISO 14644-1						
<b>Indoor air quality</b>		 A+	 E1					
<b>Cleanability</b>								
<b>Sustainability</b>		 EN ISO 14021 43%	 BIOSOLUBLE WOOL EC 1272/2008 Annex G	 M1+ PARTS EMISSION CLASS FOR BUILDING MATERIALS	 www.blauer-engel.de/luz132			

Products may vary from country to country.  
Please contact your local sales representative.  
For further information and legal notice, please visit our website.





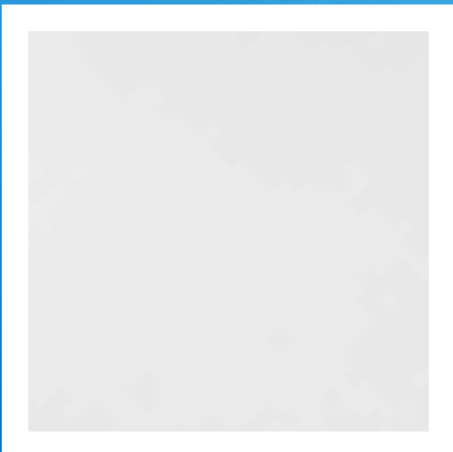

## AMF THERMATEX® Thermofon

- AMF THERMATEX® Thermofon features a smooth, white laminated finish and modern design visual. It provides high sound absorption for enhanced acoustic comfort
- High sound absorption (0.80 (H)  $\alpha_w$ )
- Excellent light reflectance (88%)
- ISO 4
- Ideal for offices, classrooms and learning applications



# AMF THERMATEX® THERMOFON

<b>Edge details</b> Additional edge details on request		Board 	Tegular 24/90 	Tegular 15/90 														
<b>Thickness (mm)</b>		15	15	15														
<b>Dimensions (mm)</b> Additional sizes on request		600 x 600 625 x 625 1200 x 600 1250 x 625	600 x 600 625 x 625 1200 x 600	600 x 600 625 x 625 1200 x 600														
<b>System</b>		Exposed demountable - System C																
<b>Weight</b>		2.9 kg / m <sup>2</sup>																
<b>Colour</b>		White																
<b>Sound absorption</b>		EN ISO 354 $\alpha_w = \mathbf{0.80 (H)}$ as per EN ISO 11654 - <b>Class B</b> <table border="1"> <thead> <tr> <th>Frequency f (Hz)</th> <th>125</th> <th>250</th> <th>500</th> <th>1000</th> <th>2000</th> <th>4000</th> </tr> </thead> <tbody> <tr> <td><math>\alpha_p</math></td> <td>0.55</td> <td>0.75</td> <td>0.75</td> <td>0.80</td> <td>0.95</td> <td>1.00</td> </tr> </tbody> </table> NRC = <b>0.85</b> as per ASTM C 423			Frequency f (Hz)	125	250	500	1000	2000	4000	$\alpha_p$	0.55	0.75	0.75	0.80	0.95	1.00
Frequency f (Hz)	125	250	500	1000	2000	4000												
$\alpha_p$	0.55	0.75	0.75	0.80	0.95	1.00												
<b>Sound attenuation</b>		EN ISO 10848-2 $D_{n,f,w} = \mathbf{28 dB}$ as per EN ISO 717-1 $CAC = \mathbf{29 dB}$ as per ASTM E 413-10																
<b>Sound reduction</b>		EN ISO 10140-2 $R_w = \mathbf{13 dB}$ as per EN ISO 717-1																
<b>Fire reaction</b>		Euroclass <b>A2-s1, d0</b> as per EN 13501-1 <b>Class A</b> as per ASTM E 84 RUS <b>KM1 (G1, V1, D1, T1)</b> as per 123-FZ																
<b>Light reflectance</b>		<b>88%</b>																
<b>Thermal conductivity</b>		$\lambda = \mathbf{0.040 W/mk}$ as per EN 12667																
<b>Humidity resistance</b>		<b>95% RH</b>																
<b>Clean room</b>		<b>ISO 4</b> as per EN ISO 14644-1																
<b>Indoor air quality</b>		 A+	 E1	 IACG														
<b>Cleanability</b>																		
<b>Sustainability</b>	 EN ISO 14021 42%	 EN ISO 14025	 EC 1272/2008 Annex 2	 M1	 <a href="http://www.blauer-engel.de/uz132">www.blauer-engel.de/uz132</a>													

Products may vary from country to country.  
Please contact your local sales representative.  
For further information and legal notice, please visit our website.









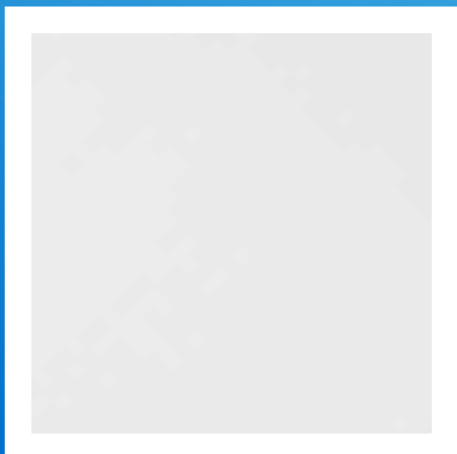



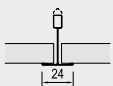
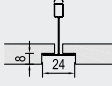
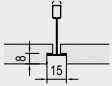















## AMF TOPIQ® Prime

- AMF TOPIQ® Prime is a very light stone wool panel with a modern, smooth surface.
- Excellent sound absorption (0.95  $\alpha_w$ )
- Excellent light reflectance (88%)
- ISO 5
- Ideal for offices, retail, classrooms, learning applications and underground garages



# AMF TOPIQ® PRIME

<b>Edge details</b> Additional edge details on request		Board 	Tegular 24/90 	Tegular 15/90 														
<b>Thickness (mm)</b>		15	15	15														
<b>Dimensions (mm)</b> Additional sizes on request		600 x 600 625 x 625 1200 x 600 1250 x 625	600 x 600 625 x 625 1200 x 600	600 x 600 625 x 625 1200 x 600														
<b>System</b>		Exposed demountable - System C																
<b>Weight</b>		2.1 kg / m <sup>2</sup>																
<b>Colour</b>		White																
<b>Sound absorption</b>		EN ISO 354 $\alpha_w = \mathbf{0.95}$ as per EN ISO 11654 - <b>Class A</b> <table border="1"> <thead> <tr> <th>Frequency f (Hz)</th> <th>125</th> <th>250</th> <th>500</th> <th>1000</th> <th>2000</th> <th>4000</th> </tr> </thead> <tbody> <tr> <td><math>\alpha_p</math></td> <td>0.50</td> <td>0.85</td> <td>0.95</td> <td>0.90</td> <td>1.00</td> <td>1.00</td> </tr> </tbody> </table> NRC = <b>0.90</b> as per ASTM C 423			Frequency f (Hz)	125	250	500	1000	2000	4000	$\alpha_p$	0.50	0.85	0.95	0.90	1.00	1.00
Frequency f (Hz)	125	250	500	1000	2000	4000												
$\alpha_p$	0.50	0.85	0.95	0.90	1.00	1.00												
<b>Sound attenuation</b>		EN ISO 10848-2 $D_{n,f,w} = \mathbf{24 dB}$ as per EN ISO 717-1 CAC = <b>24 dB</b> as per ASTM E 413-10																
<b>Sound reduction</b>		EN ISO 10140-2 $R_w = \mathbf{13 dB}$ as per EN ISO 717-1																
<b>Fire reaction</b>		Euroclass <b>A1</b> as per EN 13501-1 <b>Class A</b> as per ASTM E 84 RUS <b>KM2 (G1, V2, D1, T1)</b> as per 123-FZ																
<b>Light reflectance</b>		<b>88%</b>																
<b>Humidity resistance</b>		<b>100% RH</b>																
<b>Clean room</b>		<b>ISO 5</b> as per EN ISO 14644-1																
<b>Indoor air quality</b>		 A	 E1	 IAC														
<b>Cleanability</b>																		
<b>Sustainability</b>	 EN ISO 14021 32-33%	 BIOSOLUBLE WOOL EC 1272/2008 Annex G	 M1 EMMISSION CLASS FOR BUILDING MATERIALS	 BLUE ANGEL THE GERMAN ECOCERT														

Products may vary from country to country.  
 Please contact your local sales representative.  
 For further information and legal notice, please visit our website.



## AMF TOPIQ® Efficient Pro

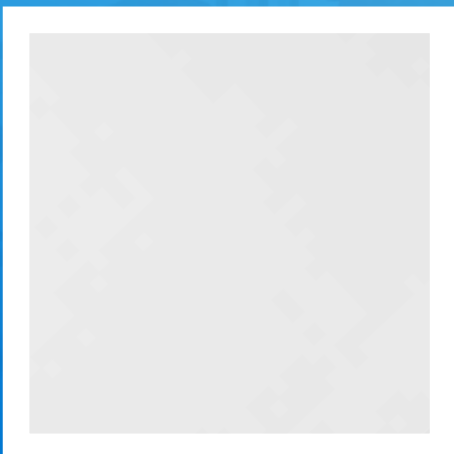

- AMF TOPIQ® Efficient Pro is a very light stone wool panel with a modern, smooth surface.
- Excellent sound absorption (1.00  $\alpha_w$ )
- Excellent light reflectance (88%)
- ISO 4
- Ideal for offices, classrooms, learning applications and underground garages



# AMF TOPIQ® EFFICIENT PRO

<b>Edge details</b> Additional edge details on request		Board 	Tegular 24/90 	Tegular 15/90 														
<b>Thickness (mm)</b>		20	20	20														
<b>Dimensions (mm)</b> Additional sizes on request		600 x 600 625 x 625 1200 x 600	600 x 600 625 x 625 1200 x 600	600 x 600 625 x 625 1200 x 600														
<b>System</b>		Exposed demountable - System C																
<b>Weight</b>		2.8 kg / m <sup>2</sup>																
<b>Colour</b>		White																
<b>Sound absorption</b>		EN ISO 354 $\alpha_w = 1.00$ as per EN ISO 11654 - <b>Class A</b> <table border="1"> <thead> <tr> <th>Frequency <i>f</i> (Hz)</th> <th>125</th> <th>250</th> <th>500</th> <th>1000</th> <th>2000</th> <th>4000</th> </tr> </thead> <tbody> <tr> <td><math>\alpha_p</math></td> <td>0.45</td> <td>0.90</td> <td>1.00</td> <td>0.95</td> <td>1.00</td> <td>1.00</td> </tr> </tbody> </table> NRC = <b>0.95</b> as per ASTM C 423			Frequency <i>f</i> (Hz)	125	250	500	1000	2000	4000	$\alpha_p$	0.45	0.90	1.00	0.95	1.00	1.00
Frequency <i>f</i> (Hz)	125	250	500	1000	2000	4000												
$\alpha_p$	0.45	0.90	1.00	0.95	1.00	1.00												
<b>Sound attenuation</b>		EN ISO 10848-2 $D_{n,f,w} = 25 \text{ dB}$ as per EN ISO 717-1 CAC = <b>25 dB</b> as per ASTM E 413-10																
<b>Sound reduction</b>		EN ISO 10140-2 $R_w = 15 \text{ dB}$ as per EN ISO 717-1																
<b>Fire reaction</b>		Euroclass <b>A1</b> as per EN 13501-1 RUS <b>KM2 (G1, V2, D1, T1)</b> as per 123-FZ																
<b>Light reflectance</b>		<b>88%</b>																
<b>Humidity resistance</b>		<b>100% RH</b>																
<b>Clean room</b>		<b>ISO 4</b> as per EN ISO 14644-1																
<b>Indoor air quality</b>		 A	 E1	 IAC														
<b>Cleanability</b>																		
<b>Sustainability</b>		 33%	 EC 1272/2008 Annex 6	 <a href="http://www.blauer-engel.de/uz132">www.blauer-engel.de/uz132</a>														

Products may vary from country to country.  
Please contact your local sales representative.  
For further information and legal notice, please visit our website.

# Healthcare & Hygiene

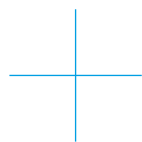





UNDER CONSTANT SCRUTINY AND DEMANDING THE HIGHEST LEVELS OF COMFORT AND CLEANLINESS, HEALTHCARE SETTINGS GO THROUGH CONTINUAL CHANGES TO ENSURE THE BEST POSSIBLE ENVIRONMENT FOR PATIENTS AND HEALTHCARE PROFESSIONALS.

Reaching the essential criteria for individual risk zones, our easy-to-clean products deliver a strong acoustic performance, with impressive sound-absorbing and sound-blocking properties to help create privacy, as well as bring in daylight to reduce in-patient time.



# ARMSTRONG BIOGUARD ACOUSTIC OP



- Armstrong BIOGUARD ACOUSTIC OP is suitable for demanding healthcare applications requiring Class A sound absorption and stringent cleaning methods: dry steam and damp cloth using standard detergents. It does not contribute to the growth of MRSA
- Excellent sound absorption (0.95  $\alpha_w$ )
- Good light reflectance (85%)
- ISO 3
- Ideal for healthcare environments with severe risk of infection



# ARMSTRONG BIOGUARD ACOUSTIC OP

<b>Edge details</b> Additional edge details on request		Board 	Tegular 24 	Tegular 15/90 														
<b>Thickness (mm)</b>		20	20	20														
<b>Dimensions (mm)</b> Additional sizes on request		600 x 600 1200 x 600	600 x 600 1200 x 600	600 x 600 1200 x 600														
<b>System</b>		Exposed demountable - System C																
<b>Weight</b>		3.3 kg / m <sup>2</sup>																
<b>Colour</b>		White																
<b>Sound absorption</b>		EN ISO 354 $\alpha_w = \mathbf{0.95}$ as per EN ISO 11654 - <b>Class A</b> <table border="1"> <thead> <tr> <th>Frequency f (Hz)</th> <th>125</th> <th>250</th> <th>500</th> <th>1000</th> <th>2000</th> <th>4000</th> </tr> </thead> <tbody> <tr> <td><math>\alpha_p</math></td> <td>0.55</td> <td>0.85</td> <td>0.95</td> <td>0.90</td> <td>1.00</td> <td>1.00</td> </tr> </tbody> </table> NRC = <b>0.95</b> as per ASTM C 423			Frequency f (Hz)	125	250	500	1000	2000	4000	$\alpha_p$	0.55	0.85	0.95	0.90	1.00	1.00
Frequency f (Hz)	125	250	500	1000	2000	4000												
$\alpha_p$	0.55	0.85	0.95	0.90	1.00	1.00												
<b>Sound attenuation</b>		EN ISO 10848-2 $D_{n,f,w} = \mathbf{25\ dB}$ as per EN ISO 717-1 CAC = <b>25 dB</b> as per ASTM E 413-10																
<b>Fire reaction</b>		Euroclass <b>A2-s1, d0</b> as per EN 13501-1 <b>Class A</b> as per ASTM E 84 RUS <b>KM1 (G1, V1, D1, T1)</b> as per 123-FZ																
<b>Light reflectance</b>		<b>85%</b>																
<b>Thermal conductivity</b>		$\lambda = \mathbf{0.040\ W/mk}$ as per EN 12667																
<b>Humidity resistance</b>		<b>95% RH</b>																
<b>Clean room</b>		<b>ISO 3</b> as per EN ISO 14644-1																
<b>Indoor air quality</b>		 A+	 E1	 IACG														
<b>Cleanability</b>																		
<b>Sustainability</b>		 EN ISO 14021 70%	 EN ISO 14025	 Woolmark EC 1272/2008 Annex C														

Products may vary from country to country.  
Please contact your local sales representative.  
For further information and legal notice, please visit our website.



# ARMSTRONG BIOGUARD ACOUSTIC



- Armstrong BIOGUARD ACOUSTIC combines excellent cleanability, resistance to disinfectants and sound absorption. Along with its antimicrobial performance, it is an ideal solution for healthcare environments
- Good sound absorption (0.60(H)  $\alpha_w$ ) and sound attenuation (36 dB)
- Good light reflectance (85%)
- ISO 4
- Ideal for healthcare environments with average or severe risk of infection



# ARMSTRONG BIOGUARD ACOUSTIC

<b>Edge details</b> Additional edge details on request		Board 	Tegular 24 	Tegular 15 														
<b>Thickness (mm)</b>		17	17	17														
<b>Dimensions (mm)</b> Additional sizes on request		600 x 600 1200 x 600	600 x 600 1200 x 600	600 x 600 1200 x 600														
<b>System</b>		Exposed demountable - System C																
<b>Weight</b>		4.5 kg / m <sup>2</sup>																
<b>Colour</b>		White																
<b>Sound absorption</b>		EN ISO 354 $\alpha_w = \mathbf{0.60(H)}$ as per EN ISO 11654 - <b>Class C</b> <table border="1"> <thead> <tr> <th>Frequency f (Hz)</th> <th>125</th> <th>250</th> <th>500</th> <th>1000</th> <th>2000</th> <th>4000</th> </tr> </thead> <tbody> <tr> <td><math>\alpha_p</math></td> <td>0.35</td> <td>0.40</td> <td>0.50</td> <td>0.70</td> <td>0.85</td> <td>0.90</td> </tr> </tbody> </table> NRC = <b>0.60</b> as per ASTM C 423			Frequency f (Hz)	125	250	500	1000	2000	4000	$\alpha_p$	0.35	0.40	0.50	0.70	0.85	0.90
Frequency f (Hz)	125	250	500	1000	2000	4000												
$\alpha_p$	0.35	0.40	0.50	0.70	0.85	0.90												
<b>Sound attenuation</b>		EN ISO 10848-2 $D_{n,f,w} = \mathbf{36\ dB}$ as per EN ISO 717-1 CAC = <b>37 dB</b> as per ASTM E 413-10																
<b>Sound reduction</b>		EN ISO 10140-2 $R_w = \mathbf{18\ dB}$ as per EN ISO 717-1																
<b>Fire reaction</b>		Euroclass <b>A2-s1, d0</b> as per EN 13501-1 RUS <b>KM1 (G1, V1, D1, T1)</b> as per 123-FZ																
<b>Light reflectance</b>		<b>85%</b>																
<b>Thermal conductivity</b>		$\lambda = \mathbf{0.060\ W/mk}$ as per EN 12667																
<b>Humidity resistance</b>		<b>95% RH</b>																
<b>Clean room</b>		<b>ISO 4</b> as per EN ISO 14644-1																
<b>Indoor air quality</b>		 A+	 E1	 IACG														
<b>Cleanability</b>																		
<b>Sustainability</b>	 EN ISO 14021 42%																	

Products may vary from country to country.  
Please contact your local sales representative.  
For further information and legal notice, please visit our website.













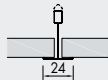
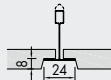
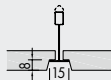















## ARMSTRONG BIOGUARD PLAIN 15mm

- Armstrong BIOGUARD PLAIN combines excellent cleanability and resistance to disinfectants. Along with its antimicrobial performance, it is an ideal solution for healthcare environments
- Good sound attenuation (35 dB)
- Excellent light reflectance (87%)
- ISO 5
- Ideal for healthcare environments with average or severe risk of infection



# ARMSTRONG BIOGUARD PLAIN 15mm

<b>Edge details</b> Additional edge details on request	 Board 	Tegular 24 	Tegular 15 														
<b>Thickness (mm)</b>	 15	15	15														
<b>Dimensions (mm)</b> Additional sizes on request	 600 x 600 1200 x 600	600 x 600 1200 x 600	600 x 600 1200 x 600														
<b>System</b>	 Exposed demountable - System C																
<b>Weight</b>	 3.5 - 3.6 kg / m <sup>2</sup>																
<b>Colour</b>	 White																
<b>Sound absorption</b>	 EN ISO 354 $\alpha_w = \mathbf{0.20(L)}$ as per EN ISO 11654 - <b>Class E</b> <table border="1" data-bbox="462 862 1452 929"> <thead> <tr> <th>Frequency f (Hz)</th> <th>125</th> <th>250</th> <th>500</th> <th>1000</th> <th>2000</th> <th>4000</th> </tr> </thead> <tbody> <tr> <td><math>\alpha_p</math></td> <td>0.40</td> <td>0.25</td> <td>0.15</td> <td>0.15</td> <td>0.20</td> <td>0.30</td> </tr> </tbody> </table> NRC = <b>0.20</b> as per ASTM C 423			Frequency f (Hz)	125	250	500	1000	2000	4000	$\alpha_p$	0.40	0.25	0.15	0.15	0.20	0.30
Frequency f (Hz)	125	250	500	1000	2000	4000											
$\alpha_p$	0.40	0.25	0.15	0.15	0.20	0.30											
<b>Sound attenuation</b>	 EN ISO 10848-2 $D_{n,f,w} = \mathbf{35\ dB}$ as per EN ISO 717-1 CAC = <b>35 dB</b> as per ASTM E 413-10																
<b>Sound reduction</b>	 EN ISO 10140-2 $R_w = \mathbf{19\ dB}$ as per EN ISO 717-1																
<b>Fire reaction</b>	 Euroclass <b>A2-s1, d0</b> as per EN 13501-1 RUS <b>KM1 (G1, V1, D1, T1)</b> as per 123-FZ																
<b>Light reflectance</b>	 <b>87%</b>																
<b>Thermal conductivity</b>	 $\lambda = \mathbf{0.060\ W/mk}$ as per EN 12667																
<b>Humidity resistance</b>	 <b>95% RH</b>																
<b>Clean room</b>	 <b>ISO 5</b> as per EN ISO 14644-1																
<b>Indoor air quality</b>	   A+      E1      IACG																
<b>Cleanability</b>	    																
<b>Sustainability</b>	  EN ISO 14021      EN ISO 14025 31 - 42%																

Products may vary from country to country.  
 Please contact your local sales representative.  
 For further information and legal notice, please visit our website.







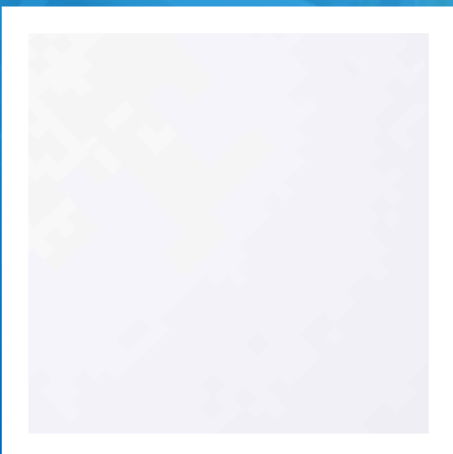



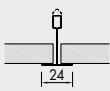
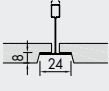
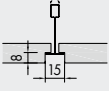











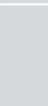

# ARMSTRONG SANIGUARD

- Armstrong SANIGUARD fulfils all hygienic requirements for healthcare applications and does not contribute to the growth of MRSA. It offers a smooth laminated finish and Class A sound absorption
- Excellent sound absorption (0.95  $\alpha_w$ )
- Good light reflectance (85%)
- ISO 5
- Ideal for healthcare environments with average risk of infection



# ARMSTRONG SANIGUARD

<b>Edge details</b> Additional edge details on request		Board 	Regular 24 	Regular 15/90 														
<b>Thickness (mm)</b>		15	15	15														
<b>Dimensions (mm)</b> Additional sizes on request		600 x 600 1200 x 600	600 x 600	600 x 600														
<b>System</b>		Exposed demountable - System C																
<b>Weight</b>		2.5 kg / m <sup>2</sup>																
<b>Colour</b>		White																
<b>Sound absorption</b>		EN ISO 354 $\alpha_w = 0.95$ as per EN ISO 11654 - <b>Class A</b> <table border="1" data-bbox="459 875 1453 954"> <thead> <tr> <th>Frequency f (Hz)</th> <th>125</th> <th>250</th> <th>500</th> <th>1000</th> <th>2000</th> <th>4000</th> </tr> </thead> <tbody> <tr> <td><math>\alpha_p</math></td> <td>0.50</td> <td>0.80</td> <td>0.95</td> <td>0.85</td> <td>0.95</td> <td>1.00</td> </tr> </tbody> </table> NRC = <b>0.90</b> as per ASTM C 423			Frequency f (Hz)	125	250	500	1000	2000	4000	$\alpha_p$	0.50	0.80	0.95	0.85	0.95	1.00
Frequency f (Hz)	125	250	500	1000	2000	4000												
$\alpha_p$	0.50	0.80	0.95	0.85	0.95	1.00												
<b>Sound attenuation</b>		EN ISO 10848-2 $D_{n,f,w} = 25 \text{ dB}$ as per EN ISO 717-1 CAC = <b>25 dB</b> as per ASTM E 413-10																
<b>Fire reaction</b>		Euroclass <b>A2-s1, d0</b> as per EN 13501-1 RUS <b>KM1 (G1, V1, D1, T1)</b> as per 123-FZ																
<b>Light reflectance</b>		<b>85%</b>																
<b>Thermal conductivity</b>		$\lambda = 0.040 \text{ W/mk}$ as per EN 12667																
<b>Humidity resistance</b>		<b>95% RH</b>																
<b>Clean room</b>		<b>ISO 5</b> as per EN ISO 14644-1																
<b>Indoor air quality</b>		 A+	 E1	 IACG														
<b>Cleanability</b>																		
<b>Sustainability</b>		 EN ISO 14021	 EN ISO 14025	 RESOLUBLE WOOL EC 227/2008 Annex C														

Products may vary from country to country.  
 Please contact your local sales representative.  
 For further information and legal notice, please visit our website.





## AMF THERMATEX® Aquatec

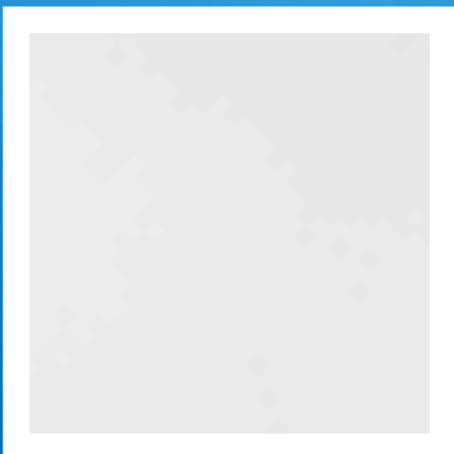

- AMF THERMATEX® Aquatec is the optimal solution for high humidity areas of up to 100% RH. It offers excellent sound absorption, and is suitable for high pressure water cleaning. Its high-quality design makes it the ideal solution for hygiene and healthcare environments
- Excellent sound absorption (0.90  $\alpha_w$ )
- Excellent light reflectance (88%)
- ISO 3
- Ideal for healthcare environments, laboratories, treatment rooms, locker rooms or shower areas





# AMF THERMATEX® AQUATEC

<b>Edge details</b> Additional edge details on request		Board 	Tegular 24/90 	Tegular 15/90 	Finesse 														
<b>Thickness (mm)</b>		19	19	19	19														
<b>Dimensions (mm)</b> Additional sizes on request		600 x 600 625 x 625	600 x 600 625 x 625	600 x 600 625 x 625	600 x 600 625 x 625														
<b>System</b>		Exposed demountable - System C			Concealed, demountable - System A.2 / A.3														
<b>Weight</b>		5.2 kg / m <sup>2</sup>																	
<b>Colour</b>		White																	
<b>Sound absorption</b>		EN ISO 354 $\alpha_w = 0.90$ as per EN ISO 11654 - <b>Class A</b> <table border="1"> <thead> <tr> <th>Frequency f (Hz)</th> <th>125</th> <th>250</th> <th>500</th> <th>1000</th> <th>2000</th> <th>4000</th> </tr> </thead> <tbody> <tr> <td><math>\alpha_p</math></td> <td>0.60</td> <td>0.70</td> <td>0.85</td> <td>0.90</td> <td>1.00</td> <td>1.00</td> </tr> </tbody> </table> NRC = <b>0.90</b> as per ASTM C 423				Frequency f (Hz)	125	250	500	1000	2000	4000	$\alpha_p$	0.60	0.70	0.85	0.90	1.00	1.00
Frequency f (Hz)	125	250	500	1000	2000	4000													
$\alpha_p$	0.60	0.70	0.85	0.90	1.00	1.00													
<b>Sound attenuation</b>		EN ISO 10848-2 $D_{n,f,w} = 29$ dB as per EN ISO 717-1		CAC = <b>29 dB</b> as per ASTM E 413-10															
<b>Sound reduction</b>		EN ISO 10140-2 $R_w = 16$ dB as per EN ISO 717-1																	
<b>Fire reaction</b>		Euroclass <b>A2-s1, d0</b> as per EN 13501-1 <b>Class A</b> as per ASTM E 84			RUS <b>KM1 (G1, V1, D1, T1)</b> as per 123-FZ														
<b>Light reflectance</b>		<b>88%</b>																	
<b>Thermal conductivity</b>		$\lambda = 0.060$ W/mk as per EN 12667																	
<b>Air permeability</b>		<b>PM1</b> ( $\leq 30$ m <sup>3</sup> /hm <sup>2</sup> ) as per DIN 18177																	
<b>Humidity resistance</b>		<b>100% RH</b>																	
<b>Clean room</b>		<b>ISO 3</b> as per EN ISO 14644-1																	
<b>Indoor air quality</b>		 A+	 E1	 IACG	 EUROFINS GOLD CERTIFIED PRODUCT														
<b>Cleanability</b>																			
<b>Sustainability</b>		 EN ISO 14021	 EN ISO 14025	 BIOSOLUBLE WOOL EC 1272/2008 Annex Q	 BLUE ANGEL THE GERMAN STANDARD														
		35%																	
		<a href="http://www.blauer-engel.de/uz132">www.blauer-engel.de/uz132</a>																	

Products may vary from country to country.  
 Please contact your local sales representative.  
 For further information and legal notice, please visit our website.







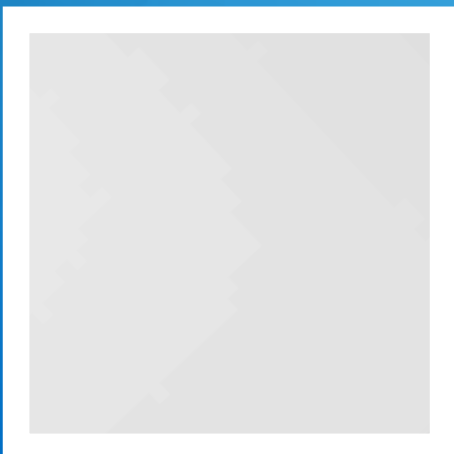



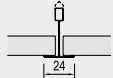











## AMF THERMATEX® Thermaclean

- AMF THERMATEX® Thermaclean combines excellent cleanability with good resistance to germs and fungi. It has a laminated finish with a white vinyl foil, that ensures a timeless look
- Good sound attenuation (34 dB)
- ISO 4
- Ideal for healthcare environments, laboratories, treatment rooms, intensive care units



# AMF THERMATEX® THERMACLEAN

<b>Edge details</b> Additional edge details on request	 Board 														
<b>Thickness (mm)</b>	 15														
<b>Dimensions (mm)</b> Additional sizes on request	 600 x 600 625 x 625														
<b>System</b>	 Exposed demountable - System C														
<b>Weight</b>	 3.6 kg / m <sup>2</sup>														
<b>Colour</b>	 White														
<b>Sound absorption</b>	EN ISO 354 $\alpha_w = 0.10$ (L) as per EN ISO 11654 <table border="1" data-bbox="464 869 1453 936"> <thead> <tr> <th>Frequency f (Hz)</th> <th>125</th> <th>250</th> <th>500</th> <th>1000</th> <th>2000</th> <th>4000</th> </tr> </thead> <tbody> <tr> <td><math>\alpha_p</math></td> <td>0.35</td> <td>0.20</td> <td>0.10</td> <td>0.10</td> <td>0.10</td> <td>0.10</td> </tr> </tbody> </table> NRC = 0.15 as per ASTM C 423	Frequency f (Hz)	125	250	500	1000	2000	4000	$\alpha_p$	0.35	0.20	0.10	0.10	0.10	0.10
Frequency f (Hz)	125	250	500	1000	2000	4000									
$\alpha_p$	0.35	0.20	0.10	0.10	0.10	0.10									
<b>Sound attenuation</b>	 EN ISO 10848-2 $D_{n,f,w} = 34$ dB as per EN ISO 717-1          CAC = 36 dB as per ASTM E 413-10														
<b>Sound reduction</b>	 EN ISO 10140-2 $R_w = 19$ dB as per EN ISO 717-1														
<b>Fire reaction</b>	 Euroclass <b>A2-s3, d0</b> as per EN 13501-1          RUS <b>KM1 (G1, V1, D1, T1)</b> as per 123-FZ														
<b>Light reflectance</b>	 <b>81%</b>														
<b>Thermal conductivity</b>	 $\lambda = 0.060$ W/mk as per EN 12667														
<b>Air permeability</b>	 <b>PM1</b> ( $\leq 30$ m <sup>3</sup> /hm <sup>2</sup> ) as per DIN 18177														
<b>Humidity resistance</b>	 <b>95% RH</b>														
<b>Clean room</b>	 <b>ISO 4</b> as per EN ISO 14644-1														
<b>Indoor air quality</b>	  A+          E1														
<b>Cleanability</b>	  														
<b>Sustainability</b>	  45%          BIODEGRADABLE WOOL <small>EN ISO 14021</small> <small>EC 1272/2008 Annex G</small>														

Products may vary from country to country.  
 Please contact your local sales representative.  
 For further information and legal notice, please visit our website.





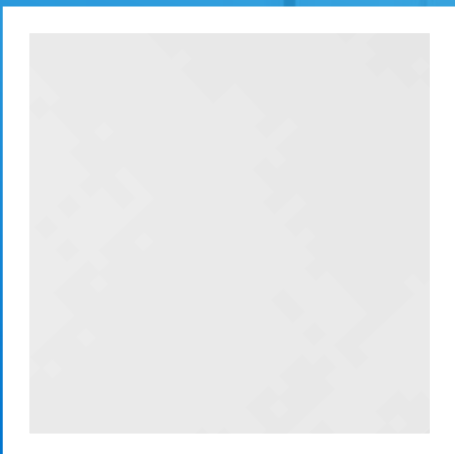







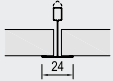
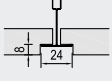
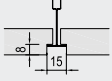











## AMF TOPIQ® Efficient Pro Hygena



- AMF TOPIQ® Efficient Pro Hygena is a very light stone wool panel with a modern, smooth surface. The surface is washable and anti-microbial (resistant to the growth of germs, bacteria and fungi)
- Excellent sound absorption (1.00  $\alpha_w$ )
- Excellent light reflectance (88%)
- ISO 4
- Ideal for healthcare facilities in general, kitchens, food industries, laboratories, etc.



# AMF TOPIQ® EFFICIENT PRO HYGENA

<b>Edge details</b> Additional edge details on request	 	Tegular 24/90 	Tegular 15/90 														
<b>Thickness (mm)</b>	 20	20	20														
<b>Dimensions (mm)</b> Additional sizes on request	 600 x 600 1200 x 600	600 x 600 625 x 625	600 x 600 625 x 625														
<b>System</b>	 Exposed demountable - System C																
<b>Weight</b>	 2.8 kg / m <sup>2</sup>																
<b>Colour</b>	 White																
<b>Sound absorption</b>	 EN ISO 354 $\alpha_w = \mathbf{1.00}$ as per EN ISO 11654 - <b>Class A</b> <table border="1" data-bbox="467 875 1453 947"> <thead> <tr> <th>Frequency <i>f</i> (Hz)</th> <th>125</th> <th>250</th> <th>500</th> <th>1000</th> <th>2000</th> <th>4000</th> </tr> </thead> <tbody> <tr> <td><math>\alpha_p</math></td> <td>0.45</td> <td>0.90</td> <td>1.00</td> <td>0.95</td> <td>1.00</td> <td>1.00</td> </tr> </tbody> </table> NRC = <b>0.95</b> as per ASTM C 423			Frequency <i>f</i> (Hz)	125	250	500	1000	2000	4000	$\alpha_p$	0.45	0.90	1.00	0.95	1.00	1.00
Frequency <i>f</i> (Hz)	125	250	500	1000	2000	4000											
$\alpha_p$	0.45	0.90	1.00	0.95	1.00	1.00											
<b>Sound attenuation</b>	 EN ISO 10848-2 $D_{n,f,w} = \mathbf{25\ dB}$ as per EN ISO 717-1 <span style="float: right;"><math>CAC = \mathbf{25\ dB}</math> as per ASTM E 413-10</span>																
<b>Sound reduction</b>	 EN ISO 10140-2 $R_w = \mathbf{15\ dB}$ as per EN ISO 717-1																
<b>Fire reaction</b>	 Euroclass <b>A1</b> as per EN 13501-1 <span style="float: right;">RUS <b>KM2 (G1, V2, D1, T1)</b> as per 123-FZ</span>																
<b>Light reflectance</b>	 <b>88%</b>																
<b>Humidity resistance</b>	 <b>100% RH</b>																
<b>Clean room</b>	 <b>ISO 4</b> as per EN ISO 14644-1																
<b>Indoor air quality</b>	 <div style="display: flex; justify-content: space-around;"> <div data-bbox="467 1449 555 1561">  <p>A</p> </div> <div data-bbox="595 1449 683 1561">  <p>E1</p> </div> </div>																
<b>Cleanability</b>	   																
<b>Sustainability</b>	  EN ISO 14021 33%																





# ARMSTRONG NEWTONE



- Armstrong NEWTONE is a hydrated calcium silicate ceiling tile offering 100% RH performance and is suitable for use in areas subject to extremes of humidity and temperature
- High sound attenuation (37 dB)
- Ideal for spas and water parks



# ARMSTRONG NEWTONE

<b>Edge details</b> Additional edge details on request	 Board 														
<b>Thickness (mm)</b>	 6														
<b>Dimensions (mm)</b> Additional sizes on request	 600 x 600														
<b>System</b>	 Exposed demountable - System C														
<b>Weight</b>	 8.0 kg / m <sup>2</sup>														
<b>Colour</b>	 White														
<b>Sound absorption</b>	 EN ISO 354 $\alpha_w = \mathbf{0.10(L)}$ as per EN ISO 11654 - <b>Class N/A</b> <table border="1" data-bbox="464 862 1453 936"> <thead> <tr> <th>Frequency f (Hz)</th> <th>125</th> <th>250</th> <th>500</th> <th>1000</th> <th>2000</th> <th>4000</th> </tr> </thead> <tbody> <tr> <td><math>\alpha_p</math></td> <td>0.25</td> <td>0.15</td> <td>0.10</td> <td>0.10</td> <td>0.10</td> <td>0.05</td> </tr> </tbody> </table> NRC = <b>0.10</b> as per ASTM C 423	Frequency f (Hz)	125	250	500	1000	2000	4000	$\alpha_p$	0.25	0.15	0.10	0.10	0.10	0.05
Frequency f (Hz)	125	250	500	1000	2000	4000									
$\alpha_p$	0.25	0.15	0.10	0.10	0.10	0.05									
<b>Sound attenuation</b>	 EN ISO 10848-2 $D_{n,f,w} = \mathbf{37\ dB}$ as per EN ISO 717-1														
<b>Fire reaction</b>	 Euroclass <b>A1-s1,d0</b> as per EN 13501-1 RUS <b>KMO (NG)</b> as per 123-FZ														
<b>Light reflectance</b>	 <b>84%</b>														
<b>Humidity resistance</b>	 <b>100% RH</b>														
<b>Indoor air quality</b>	  A+                      E1														
<b>Cleanability</b>	   														

In all environments where humidity conditions could regularly reach and/or exceed 90% RH we recommend the use of 24mm corrosive resistant grid and associated accessories.

# Classic Plain

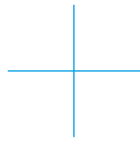

OUR CLASSIC MINERAL RANGE IS AVAILABLE IN PLAIN WHITE, OFFERING MORE REFLECTED DAYLIGHT AND HIGH LEVELS OF SOUND ATTENUATION FOR EXCELLENT ROOM TO ROOM PRIVACY.



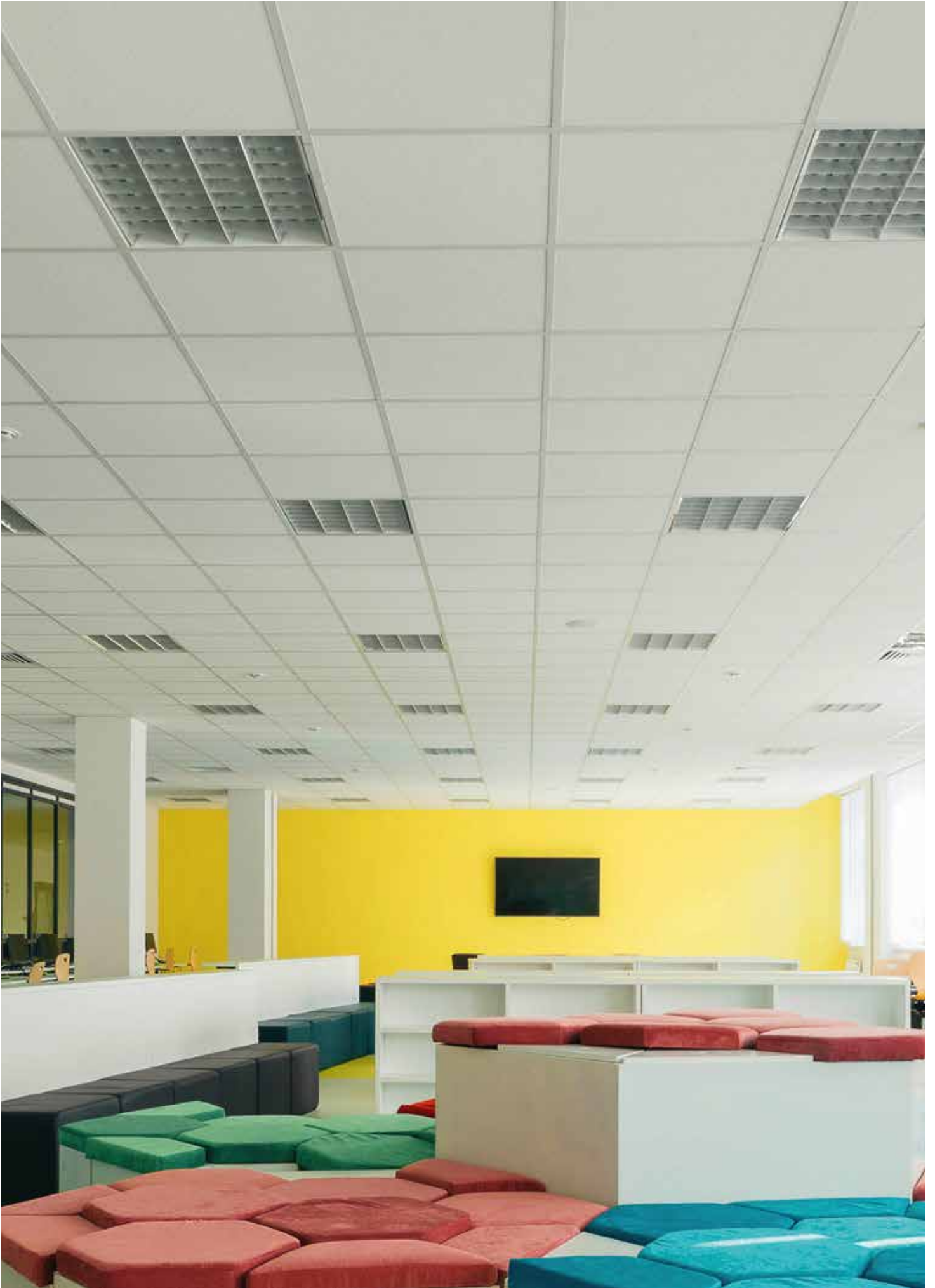



# PLAIN

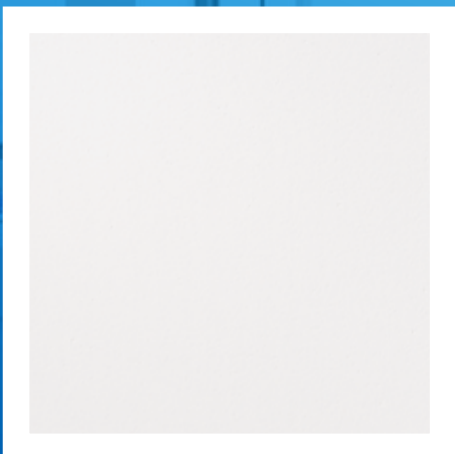









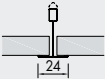
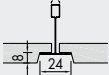
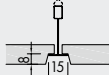











- PLAIN offers a smooth white surface that meets today's trends for cleaner finishes, whilst maximising light reflectance
- Good sound attenuation (34 dB)
- Excellent light reflectance (88%)
- Ideal for retail environments





# PLAIN

<b>Edge details</b> Additional edge details on request	 Board 	Tegular 24 	Tegular 15 														
<b>Thickness (mm)</b>	 15	15	15														
<b>Dimensions (mm)</b> Additional sizes on request	 600 x 600 1200 x 600	600 x 600 1200 x 600	600 x 600 1200 x 600														
<b>System</b>	 Exposed demountable - System C																
<b>Weight</b>	 3.6 - 3.8 kg / m <sup>2</sup>																
<b>Colour</b>	 White																
<b>Sound absorption</b>	 EN ISO 354 $\alpha_w = \mathbf{0.20(L)}$ as per EN ISO 11654 - <b>Class E</b> <table border="1" data-bbox="464 880 1453 954"> <thead> <tr> <th>Frequency f (Hz)</th> <th>125</th> <th>250</th> <th>500</th> <th>1000</th> <th>2000</th> <th>4000</th> </tr> </thead> <tbody> <tr> <td><math>\alpha_p</math></td> <td>0.30</td> <td>0.25</td> <td>0.15</td> <td>0.15</td> <td>0.25</td> <td>0.30</td> </tr> </tbody> </table> NRC = <b>0.20</b> as per ASTM C 423			Frequency f (Hz)	125	250	500	1000	2000	4000	$\alpha_p$	0.30	0.25	0.15	0.15	0.25	0.30
Frequency f (Hz)	125	250	500	1000	2000	4000											
$\alpha_p$	0.30	0.25	0.15	0.15	0.25	0.30											
<b>Sound attenuation</b>	 EN ISO 10848-2 $D_{n,f,w} = \mathbf{34\ dB}$ as per EN ISO 717-1 <span style="float: right;"><math>CAC = \mathbf{35\ dB}</math> as per ASTM E 413-10</span>																
<b>Fire reaction</b>	 Euroclass <b>A2-s1, d0</b> as per EN 13501-1 <b>Class A</b> as per ASTM E 84 <span style="float: right;"><b>RUS KM1 (G1, V1, D1, T1)</b> as per 123-FZ</span>																
<b>Light reflectance</b>	 <b>88%</b>																
<b>Thermal conductivity</b>	 $\lambda = \mathbf{0.060\ W/mK}$ as per EN 12667																
<b>Humidity resistance</b>	 <b>95% RH</b>																
<b>Clean room</b>	 <b>ISO 4</b> as per EN ISO 14644-1																
<b>Indoor air quality</b>	 A+	 E1	 IACG														
<b>Cleanability</b>																	
<b>Sustainability</b>	 EN ISO 14021 31 - 48%	 EN ISO 14025	 BIOSOLUBLE WOOL EC 1272/2008 Annex D														

Products may vary from country to country.  
 Please contact your local sales representative.  
 For further information and legal notice, please visit our website.











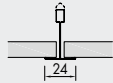











## ARMSTRONG RETAIL

- Armstrong RETAIL offers a smooth, unperforated contemporary visual that provides energy savings due to its high level of light reflectance
- Excellent light reflectance (87%)
- Ideal for retail environments



# ARMSTRONG RETAIL

<b>Edge details</b> Additional edge details on request	 Board 														
<b>Thickness (mm)</b>	 12														
<b>Dimensions (mm)</b> Additional sizes on request	 600 x 600 1200 x 600														
<b>System</b>	 Exposed demountable - System C														
<b>Weight</b>	 3.1 kg / m <sup>2</sup>														
<b>Colour</b>	 White														
<b>Sound absorption</b>	 EN ISO 354 $\alpha_w = \mathbf{0.15(L)}$ as per EN ISO 11654 - <b>Class E</b> <table border="1" data-bbox="459 862 1452 936"> <thead> <tr> <th>Frequency f (Hz)</th> <th>125</th> <th>250</th> <th>500</th> <th>1000</th> <th>2000</th> <th>4000</th> </tr> </thead> <tbody> <tr> <td><math>\alpha_p</math></td> <td>0.30</td> <td>0.25</td> <td>0.15</td> <td>0.10</td> <td>0.10</td> <td>0.20</td> </tr> </tbody> </table> NRC = <b>0.15</b> as per ASTM C 423	Frequency f (Hz)	125	250	500	1000	2000	4000	$\alpha_p$	0.30	0.25	0.15	0.10	0.10	0.20
Frequency f (Hz)	125	250	500	1000	2000	4000									
$\alpha_p$	0.30	0.25	0.15	0.10	0.10	0.20									
<b>Sound attenuation</b>	 EN ISO 10848-2 $D_{n,f,w} = \mathbf{31\ dB}$ as per EN ISO 717-1 CAC = <b>31 dB</b> as per ASTM E 413-10														
<b>Fire reaction</b>	 Euroclass <b>A2-s1, d0</b> as per EN 13501-1 RUS <b>KM1 (G1, V1, D1, T1)</b> as per 123-FZ														
<b>Light reflectance</b>	 <b>87%</b>														
<b>Thermal conductivity</b>	 $\lambda = \mathbf{0.060\ W/mk}$ as per EN 12667														
<b>Humidity resistance</b>	 <b>90% RH</b>														
<b>Indoor air quality</b>	  A+                      E1														
<b>Cleanability</b>	 														
<b>Sustainability</b>	    46% <a href="http://www.blauer-engel.de/uz132">www.blauer-engel.de/uz132</a>														

Products may vary from country to country.  
 Please contact your local sales representative.  
 For further information and legal notice, please visit our website.



# Classic Sanded

WITH A FINELY TEXTURED SURFACE, THE SANDED CLASSIC MINERAL CEILING SOLUTION PROVIDES A PERFECT BALANCE OF LIGHT REFLECTANCE AND ACOUSTIC PERFORMANCE TO ENHANCE COMFORT.

















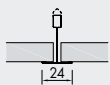
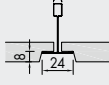
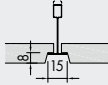
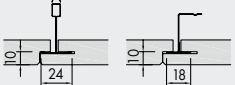









# ARMSTRONG SAHARA



- Armstrong SAHARA features a lightly textured and microperforated surface combining good sound absorption and sound attenuation performance
- Good sound absorption (0.60  $\alpha_w$ ) and sound attenuation (34 dB)
- Good light reflectance (85%)
- Ideal for office and learning applications



# ARMSTRONG SAHARA

<b>Edge details</b> Additional edge details on request	 <div style="display: flex; justify-content: space-around;"> <div style="text-align: center;"> <p>Board</p>  </div> <div style="text-align: center;"> <p>Tegular 24</p>  </div> <div style="text-align: center;"> <p>Tegular 15</p>  </div> <div style="text-align: center;"> <p>SL2</p>  </div> </div>																							
<b>Thickness (mm)</b>	 <div style="display: flex; justify-content: space-around;"> <div style="text-align: center;">15</div> <div style="text-align: center;">15</div> <div style="text-align: center;">15</div> <div style="text-align: center;">19</div> </div>																							
<b>Dimensions (mm)</b> Additional sizes on request	 <div style="display: flex; justify-content: space-around;"> <div style="text-align: center;"> <p>600 x 600 675 x 675 1200 x 600 1500 x 300 1800 x 300</p> </div> <div style="text-align: center;"> <p>600 x 600 675 x 675 1200 x 600</p> </div> <div style="text-align: center;"> <p>600 x 600 675 x 675 1200 x 600 1200 x 300</p> </div> <div style="text-align: center;"> <p>1500 x 300 1800 x 300 2500 x 300</p> </div> </div>																							
<b>System</b>	 <div style="display: flex; justify-content: space-between;"> <div style="width: 65%;"> <p>Exposed demountable - System C            Exposed - Bandraster, demountable - System I.3            Exposed - Corridor, demountable - System F.3</p> </div> <div style="width: 30%;"> <p>Semi-concealed planks, demountable - System I.3            Semi-concealed planks - Bandraster, demountable - System I.2            Semi-concealed - Corridor, demountable - System F.2</p> </div> </div>																							
<b>Weight</b>	 <p>3.7 - 5.0 kg / m<sup>2</sup> (15 - 19mm)</p>																							
<b>Colour</b>	 <p>White</p>																							
<b>Sound absorption</b>	 <p>EN ISO 354  <math>\alpha_w = 0.60</math> as per EN ISO 11654 - <b>Class C</b></p> <table border="1" style="width: 100%; border-collapse: collapse;"> <thead> <tr> <th colspan="2">Frequency <i>f</i> (Hz)</th> <th>125</th> <th>250</th> <th>500</th> <th>1000</th> <th>2000</th> <th>4000</th> </tr> </thead> <tbody> <tr> <td rowspan="2"><math>\alpha_p</math></td> <td>Board, Tegular</td> <td>0.45</td> <td>0.40</td> <td>0.55</td> <td>0.65</td> <td>0.65</td> <td>0.60</td> </tr> <tr> <td>SL2</td> <td>0.35</td> <td>0.45</td> <td>0.60</td> <td>0.65</td> <td>0.55</td> <td>0.45</td> </tr> </tbody> </table> <p>NRC = <b>0.55</b> as per ASTM C 423</p>	Frequency <i>f</i> (Hz)		125	250	500	1000	2000	4000	$\alpha_p$	Board, Tegular	0.45	0.40	0.55	0.65	0.65	0.60	SL2	0.35	0.45	0.60	0.65	0.55	0.45
Frequency <i>f</i> (Hz)		125	250	500	1000	2000	4000																	
$\alpha_p$	Board, Tegular	0.45	0.40	0.55	0.65	0.65	0.60																	
	SL2	0.35	0.45	0.60	0.65	0.55	0.45																	
<b>Sound attenuation</b>	 <div style="display: flex; justify-content: space-between;"> <div style="width: 48%;"> <p>EN ISO 10848-2  <math>D_{n,f,w} = 34 \text{ dB}</math> (15mm) as per EN ISO 717-1            CAC = <b>35 dB</b> (15mm) as per ASTM E 413-10</p> </div> <div style="width: 48%;"> <p><math>D_{n,f,w} = 38 \text{ dB}</math> (19mm) as per EN ISO 717-1            CAC = <b>39 dB</b> (19mm) as per ASTM E 413-10</p> </div> </div>																							
<b>Sound reduction</b>	 <div style="display: flex; justify-content: space-between;"> <div style="width: 48%;"> <p>EN ISO 10140-2  <math>R_w = 17 \text{ dB}</math> (15mm) as per EN ISO 717-1</p> </div> <div style="width: 48%;"> <p><math>R_w = 21 \text{ dB}</math> (19mm) as per EN ISO 717-1</p> </div> </div>																							
<b>Fire reaction</b>	 <div style="display: flex; justify-content: space-between;"> <div style="width: 48%;"> <p>Euroclass <b>A2-s1, d0</b> as per EN 13501-1</p> </div> <div style="width: 48%;"> <p>RUS <b>KM1 (G1, V1, D1, T1)</b> as per 123-FZ</p> </div> </div>																							
<b>Light reflectance</b>	 <p><b>85%</b></p>																							
<b>Thermal conductivity</b>	 <p><math>\lambda = 0.060 \text{ W/mk}</math> as per EN 12667</p>																							
<b>Humidity resistance</b>	 <p><b>95% RH</b></p>																							
<b>Indoor air quality</b>	<div style="display: flex; justify-content: space-around; align-items: center;"> <div style="text-align: center;">  <p>A+</p> </div> <div style="text-align: center;">  <p>E1</p> </div> <div style="text-align: center;">  <p>IACG</p> </div> </div>																							
<b>Cleanability</b>	<div style="display: flex; justify-content: space-around;">   </div>																							
<b>Sustainability</b>	<div style="display: flex; justify-content: space-around; align-items: center;"> <div style="text-align: center;">  <p>EN ISO 14021</p> </div> <div style="text-align: center;">  <p>EN ISO 14025</p> </div> <div style="text-align: center;">  <p>Woolmark</p> </div> </div> <p>37 - 43%</p>																							

Products may vary from country to country.  
 Please contact your local sales representative.  
 For further information and legal notice, please visit our website.



## AMF THERMATEX® Feinstratos

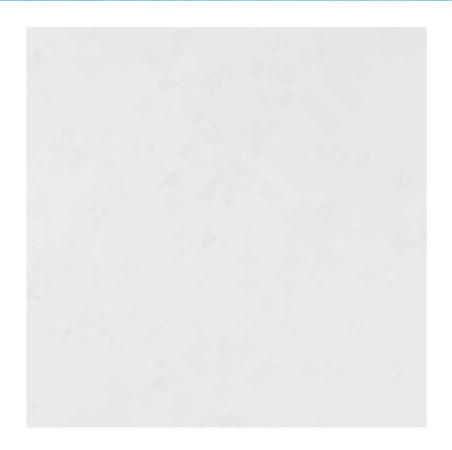

- AMF THERMATEX® Feinstratos creates an even, uniform ceiling appearance due to its finely textured surface
- Good sound attenuation (34 dB)
- Good light reflectance (85%)
- Ideal for retail, meeting rooms, installation rooms or production areas



# AMF THERMATEX® FEINSTRATOS

<b>Edge details</b> Additional edge details on request		Board 	Tegular 24 	Tegular 15 	Finesse 	SL2 	K2C2 				
<b>Thickness (mm)</b>		15	15	15	19	19	15				
<b>Dimensions (mm)</b> Additional sizes on request		600 x 600 625 x 625 1200 x 600 1250 x 625 1800 x 300 2500 x 300	600 x 600 625 x 625 1200 x 600	600 x 600 625 x 625 1200 x 600	600 x 600	2000 x 312,5 2500 x 312,5	2000 x 312,5 2500 x 312,5				
<b>System</b>		Exposed demountable - System C Exposed - Bandraster, demountable - System I.3 Exposed - Corridor, demountable - System F.3			Concealed, demountable - System A.2 / A.3	Semi-concealed planks, demountable - System I.3 Semi-concealed planks - Bandraster, demountable - System I.2 Semi-concealed planks - Corridor, demountable - System F.2	Semi-concealed planks, non-demountable - System I.3 Semi-concealed planks - Bandraster, non-demountable - System I.1 Semi-concealed planks - Corridor, non-demountable - System F.1				
<b>Weight</b>		3.8 - 5.0 kg / m <sup>2</sup>									
<b>Colour</b>		White									
<b>Sound absorption</b>		EN ISO 354 $\alpha_w = 0.20$ as per EN ISO 11654 - <b>Class E</b> Frequency $f$ (Hz)									
					125	250	500	1000	2000	4000	
					$\alpha_p$	0.35	0.20	0.15	0.15	0.20	0.20
		NRC = <b>0.15</b> as per ASTM C 423									
<b>Sound attenuation</b>		EN ISO 10848-2 $D_{n,f,w} = 34$ dB (Board, Tegular 24, Tegular 15, K2C2) CAC = <b>35</b> dB (Board, Tegular 24, Tegular 15, K2C2)				$D_{n,f,w} = 38$ dB (Finesse, SL2) as per EN ISO 717-1 CAC = <b>38</b> dB (Finesse, SL2) as per ASTM E 413-10					
<b>Sound reduction</b>		EN ISO 10140-2 $R_w = 21$ dB as per EN ISO 717-1									
<b>Fire reaction</b>		Euroclass <b>A2-s1, d0</b> as per EN 13501-1			RUS <b>KM1 (G1, V1, D1, T1)</b> as per 123-FZ						
<b>Light reflectance</b>		<b>85%</b>									
<b>Thermal conductivity</b>		$\lambda = 0.060$ W/mk as per EN 12667									
<b>Humidity resistance</b>		<b>95% RH</b>									
<b>Indoor air quality</b>											
<b>Cleanability</b>											
<b>Sustainability</b>											
		37-43%									

Products may vary from country to country.  
Please contact your local sales representative.  
For further information and legal notice, please visit our website.





## AMF THERMATEX® Feinstratos Micro



- AMF THERMATEX® Feinstratos Micro features a finely textured surface and creates an even, uniform ceiling appearance with good sound absorption
- Good sound absorption (0.60  $\alpha_w$ )
- Good to high sound attenuation (34-38 dB)
- Good light reflectance (85%)
- Ideal for retail, offices and meeting rooms, installation rooms or production areas





# AMF THERMATEX® FEINSTRATOS MICRO

<b>Edge details</b> Additional edge details on request		Board 	Tegular 24 	Tegular 15 	Finesse 	SL2 	K2C2 														
<b>Thickness (mm)</b>		15, 19	15, 19	15	19	19	15														
<b>Dimensions (mm)</b> Additional sizes on request		600 x 600 625 x 625 1200 x 600 1250 x 625	600 x 600 625 x 625 1200 x 600	600 x 600 625 x 625 1200 x 600	600 x 600 625 x 625 1200 x 600	1500 x 300 1800 x 300 2000 x 312,5 2500 x 300 2500 x 312,5	2000 x 312,5 2500 x 312,5														
<b>System</b>		Exposed demountable - System C			Concealed, demountable - System A.2 / A.3	Semi-concealed planks, demountable - System I.3 Semi-concealed planks - Bandraster, demountable - System I.2 Semi-concealed planks - Corridor, demountable - System F.2	Semi-concealed planks, non-demountable - System I.3 Semi-concealed planks - Bandraster, non-demountable - System I.1 Semi-concealed planks - Corridor, non-demountable - System F.1														
<b>Weight</b>		3.9 - 5.0 kg / m <sup>2</sup>																			
<b>Colour</b>		White																			
<b>Sound absorption</b>		EN ISO 354 $\alpha_w = \mathbf{0.60}$ as per EN ISO 11654 - <b>Class C</b> <table border="1"> <thead> <tr> <th>Frequency f (Hz)</th> <th>125</th> <th>250</th> <th>500</th> <th>1000</th> <th>2000</th> <th>4000</th> </tr> </thead> <tbody> <tr> <td><math>\alpha_p</math></td> <td>0.50</td> <td>0.50</td> <td>0.55</td> <td>0.70</td> <td>0.65</td> <td>0.50</td> </tr> </tbody> </table> NRC = <b>0.60</b> as per ASTM C 423						Frequency f (Hz)	125	250	500	1000	2000	4000	$\alpha_p$	0.50	0.50	0.55	0.70	0.65	0.50
Frequency f (Hz)	125	250	500	1000	2000	4000															
$\alpha_p$	0.50	0.50	0.55	0.70	0.65	0.50															
<b>Sound attenuation</b>		EN ISO 10848-2 $D_{n,f,w} = \mathbf{34 dB}$ Board, Tegular 24, Tegular 15, K2C2 (15mm) as per EN ISO 717-1 $D_{n,f,w} = \mathbf{38 dB}$ Board, Tegular 24, Finesse, SL2 (19mm) as per EN ISO 717-1 CAC = <b>35 dB</b> (15mm) CAC = <b>38 dB</b> (19mm) as per ASTM E 413-10																			
<b>Sound reduction</b>		EN ISO 10140-2 $R_w = \mathbf{21 dB}$ as per EN ISO 717-1																			
<b>Fire reaction</b>		Euroclass <b>A2-s1, d0</b> as per EN 13501-1 <b>Class A</b> as per ASTM E 84				RUS <b>KM1 (G1, V1, D1, T1)</b> as per 123-FZ															
<b>Light reflectance</b>		<b>85%</b>																			
<b>Thermal conductivity</b>		$\lambda = \mathbf{0.060 W/mk}$ as per EN 12667																			
<b>Humidity resistance</b>		<b>95% RH</b>																			
<b>Indoor air quality</b>		 A+	 E1	 IACG																	
<b>Cleanability</b>																					
<b>Sustainability</b>		 EN ISO 14021	 EN ISO 14025	 EC 1272/2008 Annex G	37-43%																

Products may vary from country to country.  
Please contact your local sales representative.  
For further information and legal notice, please visit our website.







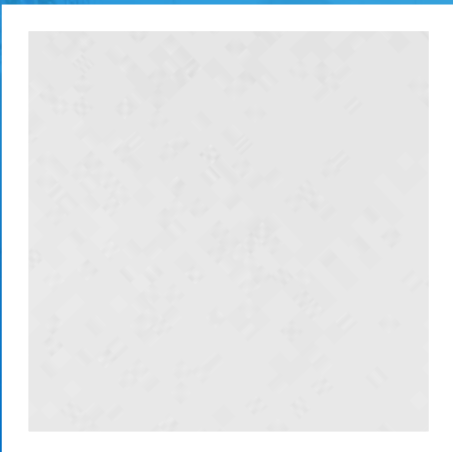



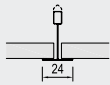

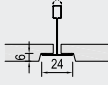











# AMF ECOMIN Orbit

- AMF ECOMIN Orbit is a cost-effective ceiling solution with a fine textured surface.
- Good light reflectance (85%)
- Ideal for retail environments



# AMF ECOMIN ORBIT

<b>Edge details</b> Additional edge details on request	 Board 	 Tegular 24 														
<b>Thickness (mm)</b>	 13	 14														
<b>Dimensions (mm)</b> Additional sizes on request	 600 x 600 1200 x 600	 600 x 600 1200 x 600														
<b>System</b>	 Exposed demountable - System C															
<b>Weight</b>	 3.2 - 3.3 kg / m <sup>2</sup>															
<b>Colour</b>	 White															
<b>Sound absorption</b>	 EN ISO 354 $\alpha_w = \mathbf{0.20 (L)}$ as per EN ISO 11654 - <b>Class E</b> <table border="1" data-bbox="464 887 1453 958"> <thead> <tr> <th>Frequency <i>f</i> (Hz)</th> <th>125</th> <th>250</th> <th>500</th> <th>1000</th> <th>2000</th> <th>4000</th> </tr> </thead> <tbody> <tr> <td><math>\alpha_p</math></td> <td>0.40</td> <td>0.30</td> <td>0.15</td> <td>0.15</td> <td>0.20</td> <td>0.20</td> </tr> </tbody> </table> NRC = <b>0.20</b> as per ASTM C 423		Frequency <i>f</i> (Hz)	125	250	500	1000	2000	4000	$\alpha_p$	0.40	0.30	0.15	0.15	0.20	0.20
Frequency <i>f</i> (Hz)	125	250	500	1000	2000	4000										
$\alpha_p$	0.40	0.30	0.15	0.15	0.20	0.20										
<b>Fire reaction</b>	 Euroclass <b>A2-s1, d0</b> as per EN 13501-1															
<b>Light reflectance</b>	 <b>85%</b>															
<b>Thermal conductivity</b>	 $\lambda = \mathbf{0.060 W/mk}$ as per EN 12667															
<b>Humidity resistance</b>	 <b>70% RH</b>															
<b>Indoor air quality</b>	  A+      E1															
<b>Cleanability</b>	 															
<b>Sustainability</b>	 EN ISO 14021 31-40%  EN ISO 14025  BIOSOLUBLE WOOL EC 1272/2008 Annex G															







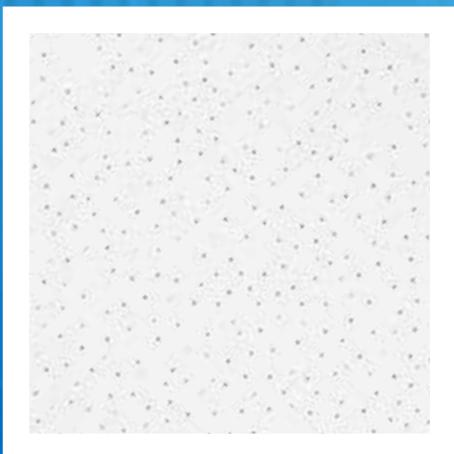



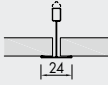
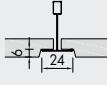











# ARMSTRONG FERIA

- Armstrong FERIA features a perforated, lightly granulated surface offering a good combination of sound absorption and sound attenuation
- Good light reflectance (85%)



# ARMSTRONG FERIA

<b>Edge details</b> Additional edge details on request	 Board 	Tegular 24 														
<b>Thickness (mm)</b>	 14	14														
<b>Dimensions (mm)</b> Additional sizes on request	 600 x 600 1200 x 600	600 x 600														
<b>System</b>	 Exposed demountable - System C															
<b>Weight</b>	 3.3 kg / m <sup>2</sup>															
<b>Colour</b>	 White															
<b>Sound absorption</b>	 EN ISO 354 $\alpha_w = 0.50$ as per EN ISO 11654 - <b>Class D</b> <table border="1" data-bbox="464 862 1453 936"> <thead> <tr> <th>Frequency f (Hz)</th> <th>125</th> <th>250</th> <th>500</th> <th>1000</th> <th>2000</th> <th>4000</th> </tr> </thead> <tbody> <tr> <td><math>\alpha_p</math></td> <td>0.35</td> <td>0.40</td> <td>0.50</td> <td>0.60</td> <td>0.55</td> <td>0.50</td> </tr> </tbody> </table> NRC = <b>0.50</b> as per ASTM C 423		Frequency f (Hz)	125	250	500	1000	2000	4000	$\alpha_p$	0.35	0.40	0.50	0.60	0.55	0.50
Frequency f (Hz)	125	250	500	1000	2000	4000										
$\alpha_p$	0.35	0.40	0.50	0.60	0.55	0.50										
<b>Sound attenuation</b>	 EN ISO 10848-2 $D_{n,f,w} = 32 \text{ dB}$ as per EN ISO 717-1 CAC = <b>32 dB</b> as per ASTM E 413-10															
<b>Fire reaction</b>	 Euroclass <b>A2-s1, d0</b> as per EN 13501-1 RUS <b>KM1 (G1, V1, D1, T1)</b> as per 123-FZ															
<b>Light reflectance</b>	 <b>85%</b>															
<b>Thermal conductivity</b>	 $\lambda = 0.060 \text{ W/mk}$ as per EN 12667															
<b>Humidity resistance</b>	 <b>90% RH</b>															
<b>Indoor air quality</b>	  A+  E1															
<b>Cleanability</b>	 															
<b>Sustainability</b>	 EN ISO 14021 33%  EN ISO 14025  WOODSOLUBLE WOOL BS 5272:2009 Annex C															

Products may vary from country to country.  
 Please contact your local sales representative.  
 For further information and legal notice, please visit our website.













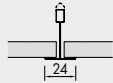









# ARMSTRONG SAVANNA

- Armstrong SAVANNA features a plain and lightly granulated surface for contemporary design
- Good light reflectance (85%)



# ARMSTRONG SAVANNA

<b>Edge details</b> Additional edge details on request	 Board 														
<b>Thickness (mm)</b>	 12														
<b>Dimensions (mm)</b> Additional sizes on request	 600 x 600														
<b>System</b>	 Exposed demountable - System C														
<b>Weight</b>	 3.4 kg / m <sup>2</sup>														
<b>Sound absorption</b>	 EN ISO 354 $\alpha_w = \mathbf{0.15(L)}$ as per EN ISO 11654 - <b>Class E</b> <table border="1" data-bbox="462 795 1452 869"> <thead> <tr> <th>Frequency <i>f</i> (Hz)</th> <th>125</th> <th>250</th> <th>500</th> <th>1000</th> <th>2000</th> <th>4000</th> </tr> </thead> <tbody> <tr> <td><math>\alpha_p</math></td> <td>0.30</td> <td>0.25</td> <td>0.15</td> <td>0.10</td> <td>0.10</td> <td>0.20</td> </tr> </tbody> </table> NRC = <b>0.15</b> as per ASTM C 423	Frequency <i>f</i> (Hz)	125	250	500	1000	2000	4000	$\alpha_p$	0.30	0.25	0.15	0.10	0.10	0.20
Frequency <i>f</i> (Hz)	125	250	500	1000	2000	4000									
$\alpha_p$	0.30	0.25	0.15	0.10	0.10	0.20									
<b>Sound attenuation</b>	 EN ISO 10848-2 $D_{n,f,w} = \mathbf{31\ dB}$ as per EN ISO 717-1 CAC = <b>31 dB</b> as per ASTM E 413-10														
<b>Fire reaction</b>	 Euroclass <b>A2-s1, d0</b> as per EN 13501-1 RUS <b>KM1 (G1, V1, D1, T1)</b> as per 123-FZ														
<b>Light reflectance</b>	 <b>85%</b>														
<b>Thermal conductivity</b>	 $\lambda = \mathbf{0.060\ W/mk}$ as per EN 12667														
<b>Humidity resistance</b>	 Up to <b>90% RH</b>														
<b>Indoor air quality</b>	  A+                      E1														
<b>Cleanability</b>	 														
<b>Sustainability</b>	    40% <a href="http://www.blauer-engel.de/uz132">www.blauer-engel.de/uz132</a>														

Products may vary from country to country.  
 Please contact your local sales representative.  
 For further information and legal notice, please visit our website.

# Classic Fissured/ Perforated

CHOOSE A FISSURED SURFACE FROM THE CLASSIC MINERAL RANGE TO ENJOY ITS UNIQUE COMBINATION OF SUPERIOR SOUND ABSORPTION AND SOUND ATTENUATION FOR IMPROVED INTELLIGIBILITY.



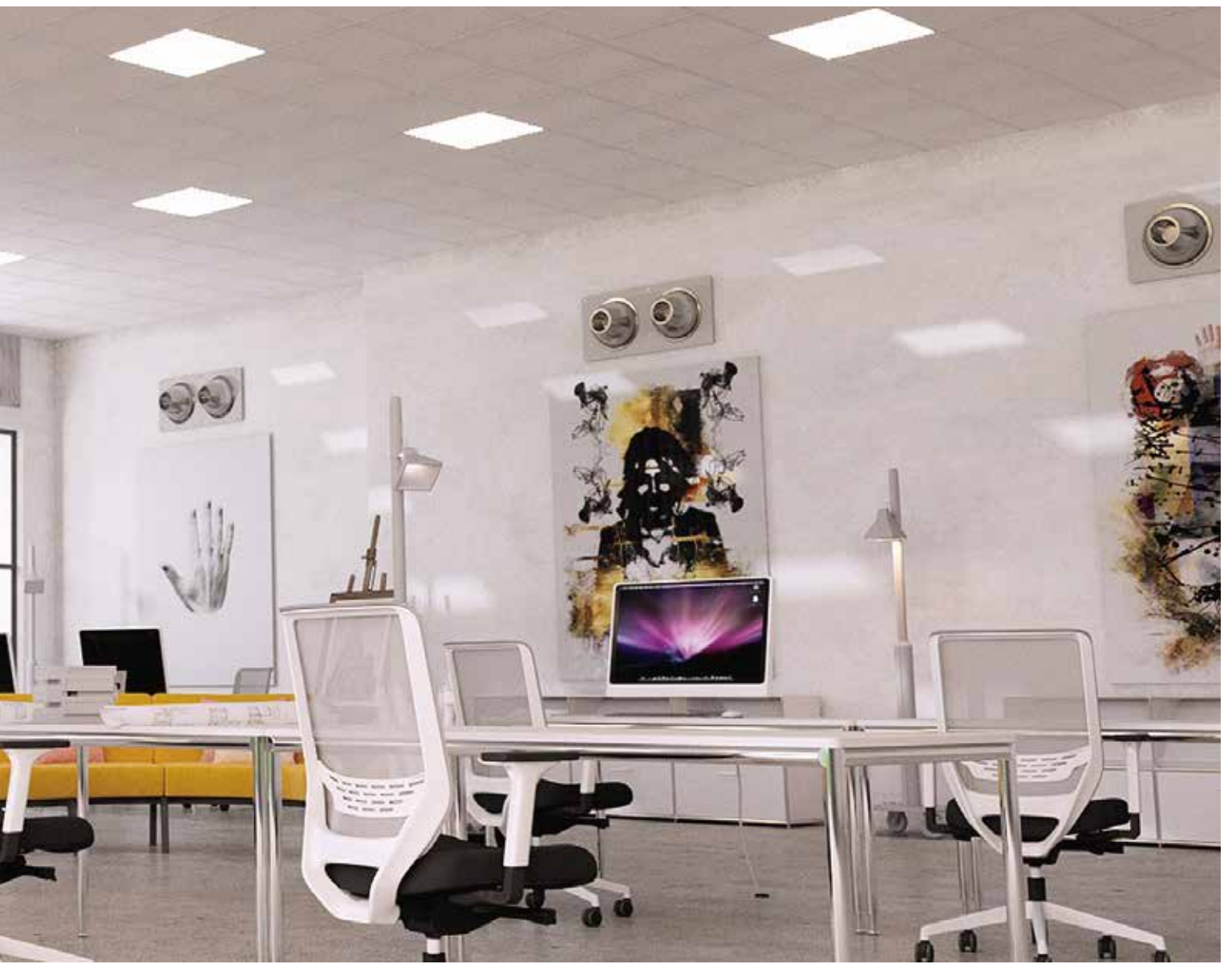





## DATASHEET

# Star 15mm



- Star 15mm features fine, uneven perforations with a smooth surface finish, and meets the needs for a modern, elegant design visual
- Good sound absorption ( $0.60 \alpha_w$ )
- Good sound attenuation (34 dB)
- Excellent light reflectance (88%)
- Ideal for retail, offices and meeting rooms, installation rooms or production areas



DATASHEET

Star 15mm

<b>Edge details</b> Additional edge details on request		Board 	Tegular 24 	Tegular 15 	K2C2 			
<b>Thickness (mm)</b>		15	15	15	15			
<b>Dimensions (mm)</b> Additional sizes on request		600 x 600 625 x 625 1200 x 600 1250 x 625 2500 x 300	600 x 600 625 x 625 1200 x 600	600 x 600 625 x 625 1200 x 600	2000 x 312,5 2500 x 312,5			
<b>System</b>		Exposed demountable - System C Exposed - Bandraster, demountable - System I.3 Exposed - Corridor, demountable - System F.3			Semi-concealed planks, non-demountable - System I.3			
<b>Weight</b>		3.6 - 3.8 kg / m <sup>2</sup>						
<b>Colour</b>		 White						
<b>Sound absorption</b>		EN ISO 354 $\alpha_w = \mathbf{0.60}$ as per EN ISO 11654 - <b>Class C</b>						
		Frequency f (Hz)	125	250	500	1000	2000	4000
		$\alpha_p$	0.45	0.50	0.55	0.70	0.65	0.50
		NRC = <b>0.60</b> as per ASTM C 423						
<b>Sound attenuation</b>		EN ISO 10848-2 $D_{n,f,w} = \mathbf{34 dB}$ as per EN ISO 717-1				CAC = <b>35 dB</b> as per ASTM E 413-10		
<b>Sound reduction</b>		EN ISO 10140-2 $R_w = \mathbf{21 dB}$ as per EN ISO 717-1						
<b>Fire reaction</b>		Euroclass <b>A2-s1, d0</b> as per EN 13501-1 <b>Class A</b> as per ASTM E 84						
<b>Light reflectance</b>		<b>88%</b>						
<b>Thermal conductivity</b>		$\lambda = \mathbf{0.060 W/mk}$ as per EN 12667						
<b>Humidity resistance</b>		<b>95% RH</b>						
<b>Indoor air quality</b>		 A+	 E1					
<b>Cleanability</b>								
<b>Sustainability</b>		 EN ISO 14021 37-48%	 EN ISO 14025	 BIOSOLUBLE WOOL EC 1272/2008 Annex Q				





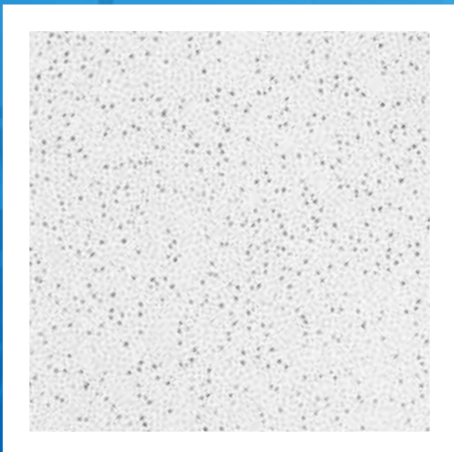







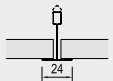

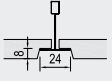

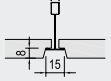











## AMF THERMATEX® Mercure



- AMF THERMATEX® Mercure is a white ceiling panel featuring fine perforations, creating a modern, high-quality surface finish
- Good sound absorption (0.60  $\alpha_w$ )
- Good light reflectance (85%)
- Ideal for retail, offices and meeting rooms, installation rooms or production areas



# AMF THERMATEX® MERCURE

<b>Edge details</b> Additional edge details on request	 Board 	 Tegular 24 	 Tegular 15 														
<b>Thickness (mm)</b>	 15	15	15														
<b>Dimensions (mm)</b> Additional sizes on request	 600 x 600 1200 x 600	600 x 600	600 x 600														
<b>System</b>	 Exposed demountable - System C																
<b>Weight</b>	 3.6 - 3.8 kg / m <sup>2</sup>																
<b>Colour</b>	 White																
<b>Sound absorption</b>	 EN ISO 354 $\alpha_w = 0.60$ as per EN ISO 11654 - <b>Class C</b> <table border="1" data-bbox="467 891 1452 958"> <thead> <tr> <th>Frequency <math>f</math> (Hz)</th> <th>125</th> <th>250</th> <th>500</th> <th>1000</th> <th>2000</th> <th>4000</th> </tr> </thead> <tbody> <tr> <td><math>\alpha_p</math></td> <td>0.45</td> <td>0.40</td> <td>0.50</td> <td>0.70</td> <td>0.70</td> <td>0.65</td> </tr> </tbody> </table> NRC = <b>0.60</b> as per ASTM C 423			Frequency $f$ (Hz)	125	250	500	1000	2000	4000	$\alpha_p$	0.45	0.40	0.50	0.70	0.70	0.65
Frequency $f$ (Hz)	125	250	500	1000	2000	4000											
$\alpha_p$	0.45	0.40	0.50	0.70	0.70	0.65											
<b>Sound attenuation</b>	 EN ISO 10848-2 $D_{n,f,w} = 32$ dB as per EN ISO 717-1 CAC = <b>32 dB</b> as per ASTM E 413-10																
<b>Sound reduction</b>	 EN ISO 10140-2 $R_w = 21$ dB as per EN ISO 717-1																
<b>Fire reaction</b>	 Euroclass <b>A2-s1, d0</b> as per EN 13501-1 <b>Class A</b> as per ASTM E 84 RUS <b>KM1 (G1, V1, D1, T1)</b> as per 123-FZ																
<b>Light reflectance</b>	 <b>85%</b>																
<b>Thermal conductivity</b>	 $\lambda = 0.060$ W/mk as per EN 12667																
<b>Humidity resistance</b>	 <b>95% RH</b>																
<b>Indoor air quality</b>	 <div style="display: flex; justify-content: space-around; align-items: center;"> <div style="text-align: center;">               A+           </div> <div style="text-align: center;">               E1           </div> <div style="text-align: center;">               IACG           </div> </div>																
<b>Cleanability</b>	 																
<b>Sustainability</b>	   37-48%																

Products may vary from country to country.  
 Please contact your local sales representative.  
 For further information and legal notice, please visit our website.

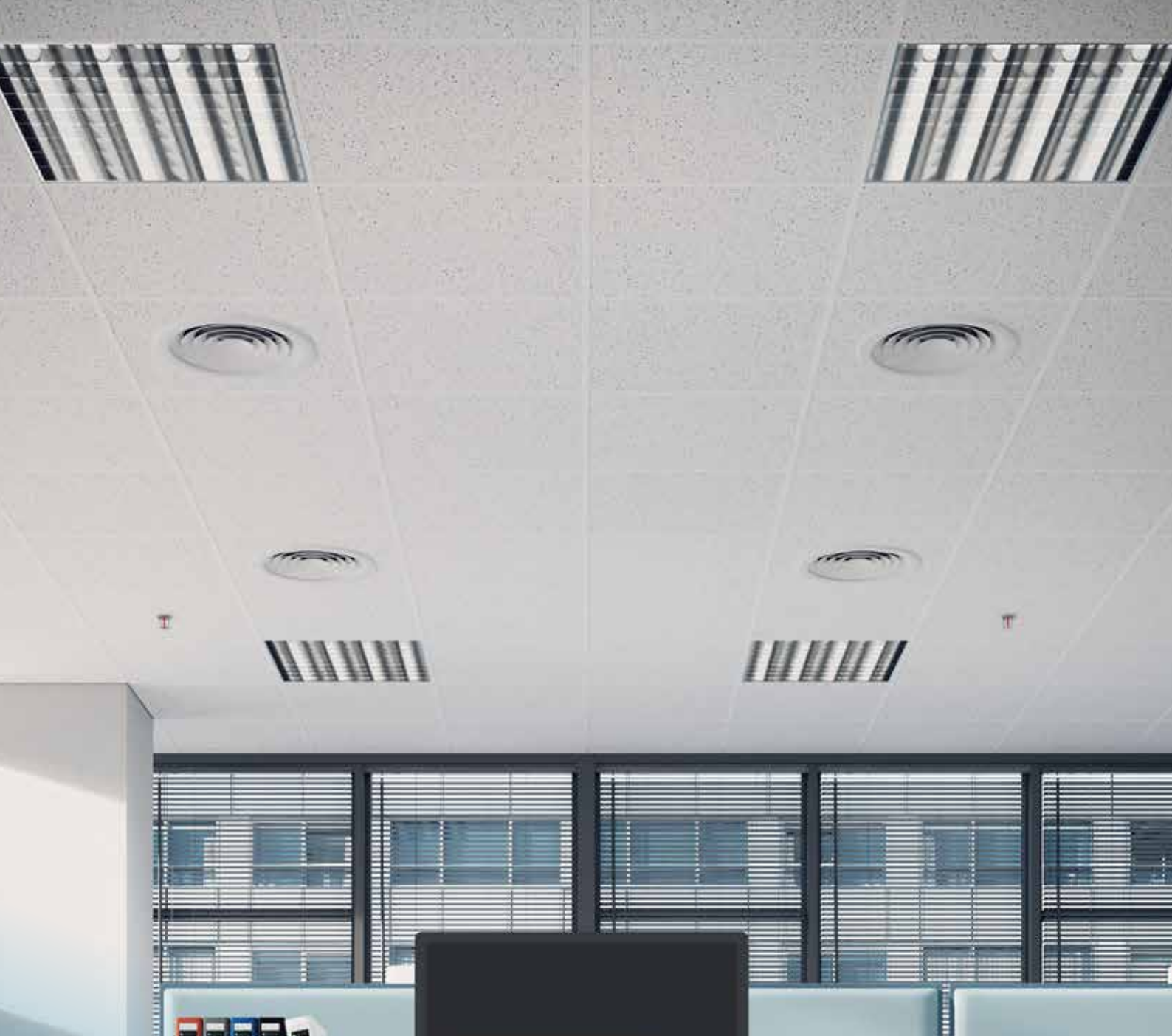









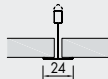
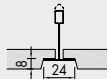
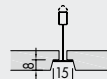











## ARMSTRONG FINE FISSURED

- Armstrong FINE FISSURED offers a non-directional surface and provides a cost-effective solution for Class C sound absorption
- Good sound absorption (0.60(H)  $\alpha_w$ )
- Good light reflectance (85%)
- Ideal for meeting rooms, circulation and waiting areas



# ARMSTRONG FINE FISSURED

<b>Edge details</b> Additional edge details on request	 Board 	Tegular 24 	Tegular 15 														
<b>Thickness (mm)</b>	 15 - 19	15 - 19	15														
<b>Dimensions (mm)</b> Additional sizes on request	 600 x 600 1200 x 600	600 x 600	600 x 600														
<b>System</b>	 Exposed demountable - System C																
<b>Weight</b>	 3.8 - 5.0 kg / m <sup>2</sup>																
<b>Colour</b>	 White																
<b>Sound absorption</b>	 EN ISO 354 $\alpha_w = \mathbf{0.60(H)}$ as per EN ISO 11654 - <b>Class C</b> <table border="1" data-bbox="459 862 1452 929"> <thead> <tr> <th>Frequency f (Hz)</th> <th>125</th> <th>250</th> <th>500</th> <th>1000</th> <th>2000</th> <th>4000</th> </tr> </thead> <tbody> <tr> <td><math>\alpha_p</math></td> <td>0.40</td> <td>0.40</td> <td>0.55</td> <td>0.75</td> <td>0.75</td> <td>0.75</td> </tr> </tbody> </table> NRC = <b>0.60</b> as per ASTM C 423			Frequency f (Hz)	125	250	500	1000	2000	4000	$\alpha_p$	0.40	0.40	0.55	0.75	0.75	0.75
Frequency f (Hz)	125	250	500	1000	2000	4000											
$\alpha_p$	0.40	0.40	0.55	0.75	0.75	0.75											
<b>Sound attenuation</b>	 EN ISO 10848-2 $D_{n,f,w} = \mathbf{32\ dB}$ (15mm) as per EN ISO 717-1 CAC = <b>32 dB</b> (15mm) as per ASTM E 413-10 $D_{n,f,w} = \mathbf{38\ dB}$ (19mm) as per EN ISO 717-1 CAC = <b>38 dB</b> (19mm) as per ASTM E 413-10																
<b>Fire reaction</b>	 Euroclass <b>A2-s1, d0</b> as per EN 13501-1 RUS <b>KM1 (G1, V1, D1, T1)</b> as per 123-FZ																
<b>Light reflectance</b>	 <b>85%</b>																
<b>Thermal conductivity</b>	 $\lambda = \mathbf{0.060\ W/mk}$ as per EN 12667																
<b>Humidity resistance</b>	 <b>95% RH</b>																
<b>Indoor air quality</b>	  A+  E1  IACG																
<b>Cleanability</b>																	
<b>Sustainability</b>	 EN ISO 14021  EN ISO 14025  100% WOLLEN WOLLE IC 5272/2008 Annex G 43 - 48%																

Products may vary from country to country.  
 Please contact your local sales representative.  
 For further information and legal notice, please visit our website.











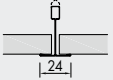
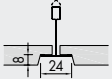

# ARMSTRONG CORTEGA

- Armstrong CORTEGA is a popular multi-directional fissured product
- Balanced acoustic solution with sound absorption  $(0.55(H) \alpha_w)$  and sound attenuation (32 dB)



# ARMSTRONG CORTEGA

<b>Edge details</b> Additional edge details on request	Board 	Tegular 24 														
<b>Thickness (mm)</b>	15	15														
<b>Dimensions (mm)</b> Additional sizes on request	600 x 600 1200 x 600	600 x 600														
<b>System</b>	Exposed demountable - System C															
<b>Weight</b>	3.6 - 3.8 kg/m <sup>2</sup>															
<b>Colour</b>	White															
<b>Sound absorption</b>	EN ISO 354 $\alpha_w = \mathbf{0.55(H)}$ as per EN ISO 11654 - <b>Class D</b> <table border="1" data-bbox="462 862 1452 929"> <thead> <tr> <th>Frequency f (Hz)</th> <th>125</th> <th>250</th> <th>500</th> <th>1000</th> <th>2000</th> <th>4000</th> </tr> </thead> <tbody> <tr> <td><math>\alpha_p</math></td> <td>0.30</td> <td>0.35</td> <td>0.50</td> <td>0.65</td> <td>0.70</td> <td>0.80</td> </tr> </tbody> </table> NRC = <b>0.55</b> as per ASTM C 423		Frequency f (Hz)	125	250	500	1000	2000	4000	$\alpha_p$	0.30	0.35	0.50	0.65	0.70	0.80
Frequency f (Hz)	125	250	500	1000	2000	4000										
$\alpha_p$	0.30	0.35	0.50	0.65	0.70	0.80										
<b>Sound attenuation</b>	EN ISO 10848-2 $D_{n,f,w} = \mathbf{32\ dB}$ as per EN ISO 717-1 CAC = <b>32 dB</b> as per ASTM E 413-10															
<b>Fire reaction</b>	Euroclass <b>A2-s1, d0</b> as per EN 13501-1	RUS <b>KM1 (G1, V1, D1, T1)</b> as per 123-FZ														
<b>Light reflectance</b>	<b>83%</b>															
<b>Thermal conductivity</b>	$\lambda = \mathbf{0.060\ W/mk}$ as per EN 12667															
<b>Humidity resistance</b>	<b>70% RH</b>															
<b>Indoor air quality</b>	 A+  E1  IACG															
<b>Cleanability</b>																
<b>Sustainability</b>	 EN ISO 14021 37%  EPD EN ISO 14025  Woolsoluble Wool															

Products may vary from country to country.  
 Please contact your local sales representative.  
 For further information and legal notice, please visit our website.



## AMF THERMATEX® Feinfresko

- AMF THERMATEX® Feinfresko features an uneven textured finish and offers good sound absorption for better acoustic comfort
- Good sound absorption (0.60 (H)  $\alpha_w$ )
- High sound attenuation (32 dB)
- Ideal for retail, offices and meeting rooms, installation rooms or production areas



# AMF THERMATEX® FEINFRESKO

<b>Edge details</b> Additional edge details on request	 Board 	Tegular 24 	Tegular 15 														
<b>Thickness (mm)</b>	 15	15	15														
<b>Dimensions (mm)</b> Additional sizes on request	 600 x 600 625 x 625 1200 x 600 1250 x 625	600 x 600 625 x 625	625 x 625														
<b>System</b>	 Exposed demountable - System C																
<b>Weight</b>	 3.6 - 3.8 kg / m <sup>2</sup>																
<b>Colour</b>	 White																
<b>Sound absorption</b>	 EN ISO 354 $\alpha_w = \mathbf{0.60 (H)}$ as per EN ISO 11654 - <b>Class C</b> <table border="1" data-bbox="467 891 1452 963"> <thead> <tr> <th>Frequency <math>f</math> (Hz)</th> <th>125</th> <th>250</th> <th>500</th> <th>1000</th> <th>2000</th> <th>4000</th> </tr> </thead> <tbody> <tr> <td><math>\alpha_p</math></td> <td>0.45</td> <td>0.40</td> <td>0.50</td> <td>0.70</td> <td>0.80</td> <td>0.75</td> </tr> </tbody> </table> NRC = <b>0.60</b> as per ASTM C 423			Frequency $f$ (Hz)	125	250	500	1000	2000	4000	$\alpha_p$	0.45	0.40	0.50	0.70	0.80	0.75
Frequency $f$ (Hz)	125	250	500	1000	2000	4000											
$\alpha_p$	0.45	0.40	0.50	0.70	0.80	0.75											
<b>Sound attenuation</b>	 EN ISO 10848-2 $D_{n,f,w} = \mathbf{32 dB}$ as per EN ISO 717-1 CAC = <b>32 dB</b> as per ASTM E 413-10																
<b>Sound reduction</b>	 EN ISO 10140-2 $R_w = \mathbf{21 dB}$ as per EN ISO 717-1																
<b>Fire reaction</b>	 Euroclass <b>A2-s1, d0</b> as per EN 13501-1 RUS <b>KM1 (G1, V1, D1, T1)</b> as per 123-FZ																
<b>Light reflectance</b>	 <b>83%</b>																
<b>Thermal conductivity</b>	 $\lambda = \mathbf{0.060 W/mk}$ as per EN 12667																
<b>Air permeability</b>	 <b>PM1</b> ( $\leq 30 \text{ m}^3/\text{hm}^2$ ) as per DIN 18177																
<b>Humidity resistance</b>	 <b>90% RH</b>																
<b>Indoor air quality</b>	  A+  E1  IACG																
<b>Cleanability</b>	 																
<b>Sustainability</b>	 EN ISO 14021  EPD EN ISO 14025  BIOSOLUBLE WOOL EC 1272/2008 Annex O 37-48%																

Products may vary from country to country.  
 Please contact your local sales representative.  
 For further information and legal notice, please visit our website.















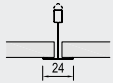







## AMF ECOMIN Filigran

- AMF ECOMIN Filigran is a cost-effective ceiling solution with a perforated surface, and is suitable for areas requiring good sound absorption
- High light reflectance (86%)
- Ideal for retail environments





# AMF ECOMIN FILIGRAN

<b>Edge details</b> Additional edge details on request	 Board 														
<b>Thickness (mm)</b>	 13														
<b>Dimensions (mm)</b> Additional sizes on request	 600 x 600 1200 x 600														
<b>System</b>	 Exposed demountable - System C														
<b>Weight</b>	 2.9 - 3.1 kg / m <sup>2</sup>														
<b>Colour</b>	 White														
<b>Sound absorption</b>	 EN ISO 354 $\alpha_w = 0.55$ as per EN ISO 11654 - <b>Class D</b> <table border="1" data-bbox="464 887 1453 958"> <thead> <tr> <th>Frequency <math>f</math> (Hz)</th> <th>125</th> <th>250</th> <th>500</th> <th>1000</th> <th>2000</th> <th>4000</th> </tr> </thead> <tbody> <tr> <td><math>\alpha_p</math></td> <td>0.45</td> <td>0.45</td> <td>0.45</td> <td>0.60</td> <td>0.60</td> <td>0.50</td> </tr> </tbody> </table> NRC = <b>0.50</b> as per ASTM C 423	Frequency $f$ (Hz)	125	250	500	1000	2000	4000	$\alpha_p$	0.45	0.45	0.45	0.60	0.60	0.50
Frequency $f$ (Hz)	125	250	500	1000	2000	4000									
$\alpha_p$	0.45	0.45	0.45	0.60	0.60	0.50									
<b>Fire reaction</b>	 Euroclass <b>A2-s1, d0</b> as per EN 13501-1 RUS <b>KM1 (G1, V1, D1, T1)</b> as per 123-FZ														
<b>Light reflectance</b>	 <b>86%</b>														
<b>Thermal conductivity</b>	 $\lambda = 0.060 \text{ W/mk}$ as per EN 12667														
<b>Humidity resistance</b>	 <b>70% RH</b>														
<b>Indoor air quality</b>	  A+      E1														
<b>Cleanability</b>	 														
<b>Sustainability</b>	   35-46%														













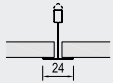







## AMF ECOMIN Planet



- AMF ECOMIN Planet is a cost effective ceiling solution that features a uniform textured finish. It provides good acoustic absorption for areas that require better acoustic comfort
- Good light reflectance (85%)
- Ideal for retail, offices and meeting rooms, installations rooms or production areas



# AMF ECOMIN PLANET

<b>Edge details</b> Additional edge details on request	 Board 														
<b>Thickness (mm)</b>	 13														
<b>Dimensions (mm)</b> Additional sizes on request	 600 x 600 1200 x 600														
<b>System</b>	 Exposed demountable - System C														
<b>Weight</b>	 2.9 - 3.1 kg / m <sup>2</sup>														
<b>Colour</b>	 White														
<b>Sound absorption</b>	 EN ISO 354 $\alpha_w = 0.55$ as per EN ISO 11654 - <b>Class D</b> <table border="1" data-bbox="467 887 1453 958"> <thead> <tr> <th>Frequency <math>f</math> (Hz)</th> <th>125</th> <th>250</th> <th>500</th> <th>1000</th> <th>2000</th> <th>4000</th> </tr> </thead> <tbody> <tr> <td><math>\alpha_p</math></td> <td>0.50</td> <td>0.40</td> <td>0.45</td> <td>0.65</td> <td>0.70</td> <td>0.65</td> </tr> </tbody> </table> NRC = <b>0.55</b> as per ASTM C 423	Frequency $f$ (Hz)	125	250	500	1000	2000	4000	$\alpha_p$	0.50	0.40	0.45	0.65	0.70	0.65
Frequency $f$ (Hz)	125	250	500	1000	2000	4000									
$\alpha_p$	0.50	0.40	0.45	0.65	0.70	0.65									
<b>Fire reaction</b>	 Euroclass <b>A2-s1, d0</b> as per EN 13501-1 RUS <b>KM1 (G1, V1, D1, T1)</b> as per 123-FZ														
<b>Light reflectance</b>	 <b>85%</b>														
<b>Thermal conductivity</b>	 $\lambda = 0.060$ W/mk as per EN 12667														
<b>Humidity resistance</b>	 <b>70% RH</b>														
<b>Indoor air quality</b>	  A+      E1														
<b>Cleanability</b>	 														
<b>Sustainability</b>	   35-46%														

Products may vary from country to country.  
 Please contact your local sales representative.  
 For further information and legal notice, please visit our website.





# Fire Protection

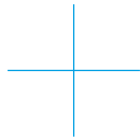

FIRE PERFORMANCE IS AN IMPORTANT CONSIDERATION FOR EVERY CEILING SYSTEM - NO MATTER HOW SIMPLE OR COMPLEX.

Our ceiling tiles are engineered to meet the most stringent industry standards. Select from a broad range of looks and acoustic options to meet your design and fire reaction requirements.



# EXPERIENCE MORE POSSIBILITIES



## AMF THERMATEX® Uno

### Uno EI 30

System Uno is a corridor span solution that offers independent fire protection EI 30 from above and below. If a fire occurs within the ceiling void, escape routes underneath remain free of smoke, flame and heat. Or if it occurs below the ceiling, the building structure and services in the ceiling void are protected. System Uno planks installed on a supporting perimeter construction can span up to 2.8m without suspension hangers, and are quick and easy to install.

The system offers good levels of sound absorption and is available in a variety of finishes.



# ARMSTRONG SUSPENSION SOLUTIONS "PRECISION MEETS PERFORMANCE"



**Knauf Ceiling Solutions suspension systems include a full range of solution and detailing for all ceiling suspension requirements. A full range of accessories is also available.**

## GENERAL SOLUTIONS

A range of standard exposed grid suspensions systems including Prelude 15, Prelude 24, Prelude 24 Sixty<sup>2</sup> for longer spans, Prelude 35 and Bandraster.

- **PEAKFORM** ▲

Most profiles in the Prelude range of grids feature the innovative Peakform design which is taller and engineered to create stronger, more stable suspension systems. The Peakform shape makes Main Runners and Cross Tees quicker and easier to cut.

- **PRELUDE UNIVERSAL MAIN RUNNER**

The Prelude Universal Main Runner supports the installation of either TL<sup>2</sup> or TL hook/butt cut Cross Tees or XL<sup>2</sup> stab/override Cross Tees from one simple inventory of Main Runners.

- **XL<sup>2</sup> CROSS TEES – "Click" installation**

Prelude XL<sup>2</sup> Cross Tees feature an advanced stab system that locates with an audible click, ensuring a solid installation at all times.

- **TL<sup>2</sup> CROSS TEES – "Hook" installation**

TL<sup>2</sup> is a highly engineered staked-on hook solution with a patented clip.

- **TL CROSS TEES – "Hook" installation**

Prelude TL Cross Tees in 15mm width feature an advanced an integrally formed hook nose.

Products may vary from country to country.  
Please contact your local sales representative.

## DESIGN SOLUTIONS



**PERFECTLINE XL<sup>2</sup>** is designed to create a crisp, clean look to provide an enhanced aesthetic. The channel profile finishes flush with the ceiling surface leaving a minimalist 3mm or 6mm reveal.

## SPECIFIC SOLUTIONS



- **Clean Room 24** is a unique co-extrusion of aluminium with a PVC gasket to create a better seal between tile and grid for clean room applications and “non-magnetic” environments.
- **Prelude 24 Corrosive Resistant** has a special paint finish and is designed for areas requiring enhanced corrosion resistance.
- **System Z** is a system providing an accessible semi-concealed appearance with ship-lap SL2 planks.
- **Seismic Rx<sup>®</sup>** is a specific installation method for Prelude 24 grid with XL<sup>2</sup> Cross Tees combined with specialist accessories.

## CORRIDOR SOLUTIONS



- Multiple corridor options from freespanning semi-concealed grid for corridors with SL2 demountable planks.

## AXIOM SOLUTIONS



- AXIOM Transitions, Profiles and accessories compliment the traditional range of perimeter angle trims. Create changes in level, perimeter lighting features or transition to a flush plasterboard perimeter.

# DONN®

## “COMPETENT AND COMPATIBLE”



**The proven DONN® DX technology with the patented gold clip has long been regarded as a guarantee for high quality ceiling grid substructures. A wide range of products guarantees consistent, flexible and certified system compatibility.**

### PRODUCT BENEFITS

- More stability, increased security, faster installation
- Three rib design for more rigidity
- Clear audible click-connection
- Compatible with all well-known acoustic ceiling tiles
- Create individual ceiling designs with alternative colour options for the capping: Black matt (LM), Metal 06 (D), Aluminium (A), Chrome (M), Gold (Q)., Additional RAL colours available on request.
- Wide range of system fire tests for all common soffit types according to the latest EN 1365-2 in conjunction with EN 1363-1

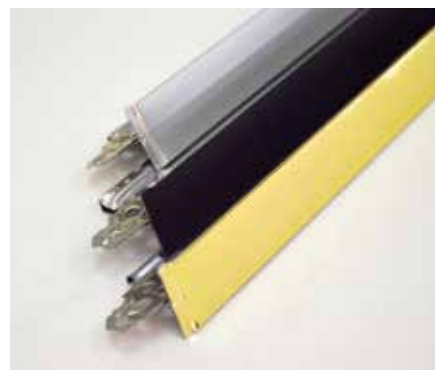

Products may vary from country to country.  
Please contact your local sales representative.



## STABLE AND SECURE CEILING GRID STRUCTURE

**The DX3® technology** with its patented rib design gives DX main runner and long cross tee ceiling grid structures even more rigidity. The profiles are dimensionally more stable and have greater torsional strength. This results in an easier and therefore faster installation and gives a stable and secure ceiling grid structure.

## PROVEN DONN® SYSTEM PORTFOLIO

### DX Standard

Create shadow gaps and reveals to highlight the modularity in a ceiling, with the DX Fineline system. The system features a box profile with a central groove (6.5mm width) along the exposed profile that creates a shadow gap of varying visibility, dependent on the rooms lighting conditions.

### Design & Aesthetic

An increasing number of ceiling constructions require special solutions, which cannot be achieved using conventional systems. These include, amongst others, wide span, heavy load, corridor and corrosion protected systems.

### Function & Creativity

All DX standard systems are characterised by a combination of subtle appearance and high efficiency. The systems are available in 24 and 15mm profile widths (visible area).



# AMF VENTATEC® “QUALITY AND FLEXIBILITY”



**High material quality and precise technical detailing characterise the standard of the profiles. The high performance product design guarantees the stability, safety and flexibility of the construction. In combination with AMF THERMATEX®, the result is a perfect ceiling solution to meet the highest requirements.**

## PRODUCT BENEFITS

- Modular system – Click (Joggled, Butt Cut)
- High stability due to stitching and ribbing
- Strong connection between main runners and cross tees as a result of the stainless steel end clips
- Easy to handle and simple to install
- Quick and easy removal of the cross tees
- Audible click confirms secure connection of Click-components
- Wide range of system fire tests for all common soffit types according to the latest EN 1365-2 in conjunction with EN 1363-1

Products may vary from country to country.  
Please contact your local sales representative.

## Individual and flexible ceiling grid structure

The AMF VENTATEC® ceiling suspension grid system offers maximum flexibility as a simple Click- construction, with high or low cross tees in both joggled and butt cut options. 24 or 15mm profile widths are available, the system can be individually adapted to many aesthetic and functional requirements.

## Certified in fire protection

We help our customers with tested fire protection systems in the ceiling area. The product and system developments introduced in recent years have been tested against the latest standards and test criteria taking all aspects of the ceiling construction (such as integrated lighting) into account. The result is a comprehensive portfolio of current fire tests with the AMF VENTATEC® grid system in combination with AMF THERMATEX® ceiling tiles protecting all relevant soffit types.



Due to reproduction processes colours shown in this catalogue may differ from the actual product colour. Product selection should always be made from Knauf Ceiling Solutions samples. All details and technical information stated in this brochure or other publicity material referring to Knauf Ceiling Solutions ceiling systems are based on test reports obtained under laboratory conditions. It is the responsibility of the customer to ensure that this data is suitable for the proposed application. All information provided is based on current technical data. Further relevant test reports, assessments and installation guidelines are available. All system details conform with current standards and are based on the use of Knauf Ceiling Solutions products and system components. Knauf Ceiling Solutions accepts no liability or responsibility for use of third party components, or for any variations to conditions stipulated in test data. Mixing of production batches is not recommended. All technical data is subject to change without prior notice and is governed by Knauf Ceiling Solutions Terms and Conditions of Sales. This catalogue supersedes all previous editions. Errors and omissions excepted. Printing errors excepted.

© Aemilie Deelder, AENA, Anke Müllerlein, Alan Jensen, Alexander Gorchakov, Alexander Orlov, Art Foto M, Baldauf & Baldauf Fotografie, Beat Buhler, Beppe Raso, Bernard Gallandi, Bettina Meckel Fotodesign, River Production, Boris Vezmar, BoysPlayNice, Braca Nadezdic, Clairelize Photography, Claude Fisicaro, Daniel Cheong, Daniel Hager, Dave Parker, David Frutos, David Güntsch, Egor Sachko, Eisma, Erieta Attali, Filip Dujardin, Filip Šlapal, Filippo di Pretoro, Foto Kushtrimi, Foto Lautenschlager, Fotostudio Eder, Francisco Urrutia, Frederic Schweizer, FUD, Grant Smith, Grigori Rassinier, Gunter Laznia, Bregenz, Hawkins\Brown - Francesco Montaguti, Hisao Suzuki, Horizon Photoworks, IAKW-AG, Andreas Hofer, Ilya Kovalev, Infinite 3D Limited, Insightful Environments, Intermontage, Bjorn Kiezenberg, Ivan Lambrev, Jack Hobhouse, Jakob Joachim, James Sleight Design Quorum, James Stephenson Photography, Jan Willem Schouten, Javier Ortega, Jiří Hloušek, Jiří Pařízek, Joao Morgado, Joel Knight, Johannes Malik, John Sturrock, Jordi Canosa, José Manuel Cutilas, Julia Stakhovskaya, Jurij Kobe, Kalibre, Kamen Valkanov, Katarzyna Ulanska, Kim Oliver, Klemen Razinger, Klomfar + Partner, Külli Salum, Laurent Wangermez, Lindman Photography, Lluís Sans, Luca Girardini, Ludwig Schedl, Marcel Van Hoorn, Matteo Zanardi, McAteer, Mecanoo, Michael van Oosten, Miguel de Guzmán, Miljenko Hegedić, Miran Kambič, Mitch van Leeuwen, Muller Fotografie, MVL Media Groep, Nail Ziyatdinov, Nike Bourgeois, Nina Boisch, Peter Matthews Photographer, Philip Durrant, Philippe Ruault, Piotr Kępka, Rafael Vargas, Raumundfunktion, Reinhard Ohner, Burghardt ZT GmbH, Rainer Tapper, Renato Izzi, rlc ag, Rob van Esch, Romain Boileux, Rudi Walti, Sandro Lendler, Sebastien Puiatti, Sergei Ananiev, Sergej Kadulin, Sergiy Kadulin Photography, Sergei Kobylko, Simon Garcia, Simon Miles, Siobhan Doran, Sonja Bell, SpheroVision, Studio A&D Architects, StudioVU, Szymon Polański, Tim Soar, Tom Green, U. Beuttemuller, U1, Valerian Wurzer, Vedrana Ergic, Walter Henisch, Wenzel, Wincasa AG, Zara Meller, Žiga Intihar.

YOUR CEILING  
OUR SOLUTIONS

**Knauf Ceilings Solutions GmbH & Co. KG**

Elsenthal 15,  
94481 Grafenau, Germany  
Phone: +49 8552 422-0  
Fax: +49 9323 318-881-856  
[www.knaufceilingsolutions.com](http://www.knaufceilingsolutions.com)  
E-Mail: [info.kcs@knauf.com](mailto:info.kcs@knauf.com)

Registered court: Passau district court,  
Registration No.: HRB 1023  
VAT No. pursuant to § 27a of the German VAT Act  
(Umsatzsteuergesetz): DE131249009  
Managing Director:  
Karl Wenig