

	Airbag		Stored gas inflator		Seat belt pretensioner		SRS control unit		Pedestrian protection active system
	Automatic rollover protection system		Gas strut / Preloaded spring		High strength zone		Zone requiring special attention		High voltage component
	Battery low-voltage		Ultra-capacitor, low voltage		Fuel tank		Gas tank		Safety value
	Battery pack, high-voltage		High voltage power cable		High voltage device that disconnects high voltage		Fuse box disabling high voltage		High voltage ultra capacitor

1. Identification / recognition



Brand Emblem

STARIA

Car model name



Brand Emblem

HTRAC

All Wheel Drive



2. Immobilisation / stabilisation / lifting

■ Immobilisation



1. push the P button
2. Pull the switch to set the parking brake.

AT(SBW) only

■ Lifting positions at car underbody

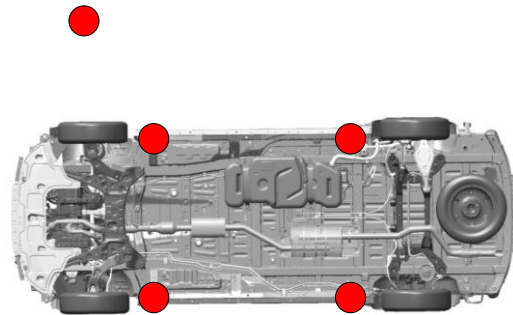
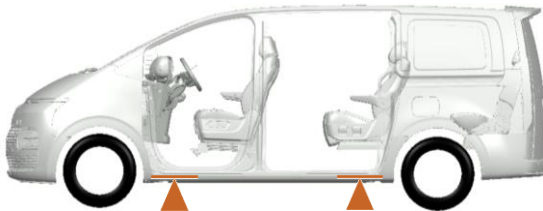

Do not place cribbing such as wooden blocks or rescue air lifting bags under the exhaust system, fuel system or high voltage power cables. The failure will cause of fire, electric shock or gas leak.

3. Disable direct hazards / safety regulations

■ Access to 12V battery

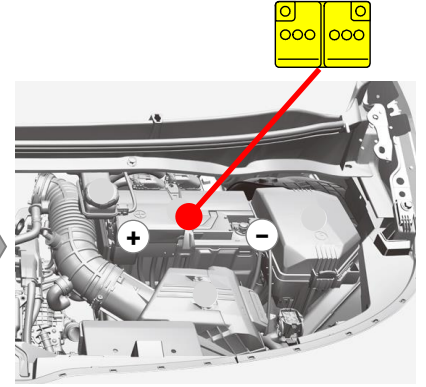
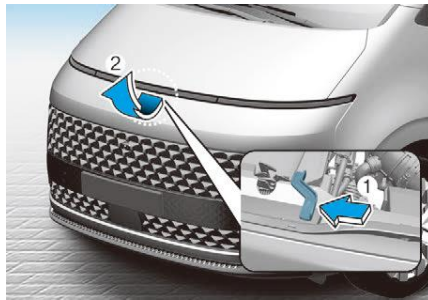
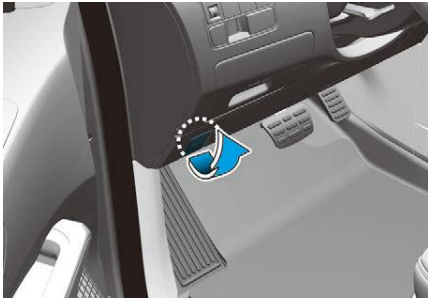
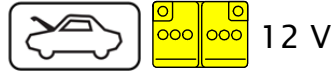

1. Pull the release lever to unlatch the hood. The hood should pop open slightly.

2. Go to the front of the vehicle, raise the hood slightly, push the secondary latch (1) up side and lift the hood (2).

Battery in the engine room

■ Disabling procedure

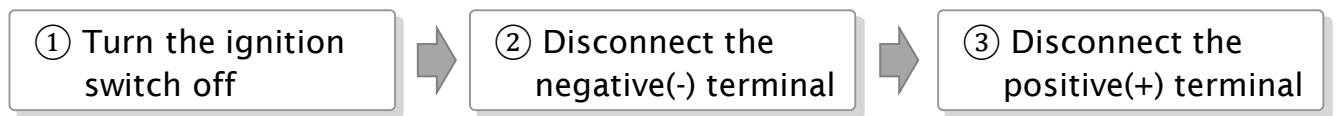

■ Glass

1 : Laminated
2-5 : Tempered



■ Vehicle body

Hardened Steel

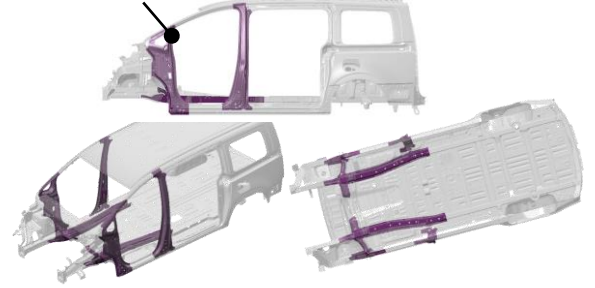

■ Steering column adjustment ■ Seat adjustment

Manual type

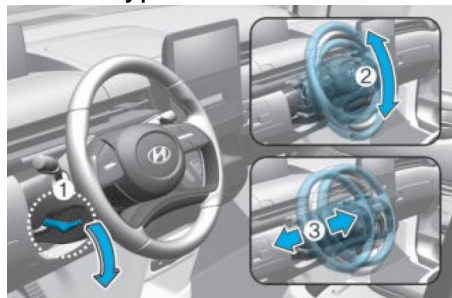

- Pull down the lock release lever(①)
- Adjust the steering wheel angle (②) and height(③)

1st row : Mechanical



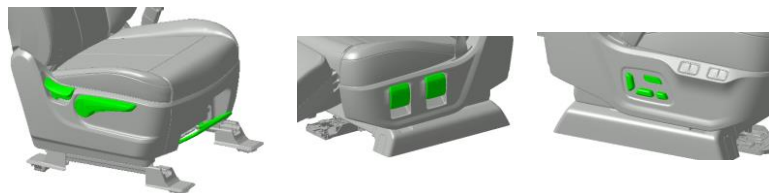

2nd row : Mechanical



3rd row : Mechanical

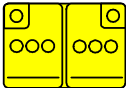

5. Stored energy / liquids / gases / solids

		<p>max. 75L</p>
		<p>12 V</p>

6. In case of fire

■ Gas Strut



Risk of missile effect of tailgate.

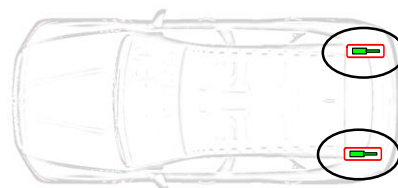

8. Towing / transportation / storage

OK :

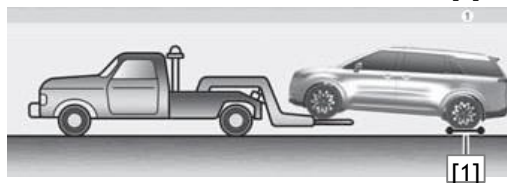
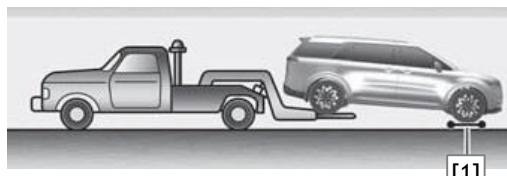
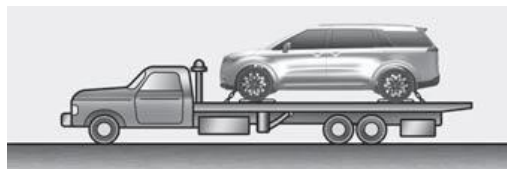

Not OK :



[1] : Dolly

Notice: AWD (All Wheel Drive) vehicle must be towed with all wheels off the ground, either on a flatbed tow truck or using dollies.