

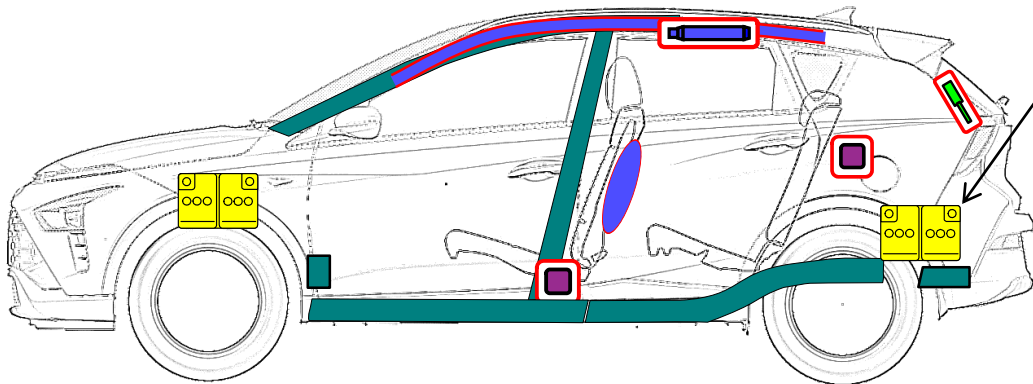

Hyundai BAYON mild hybrid 48V
5 doors
From March 2021

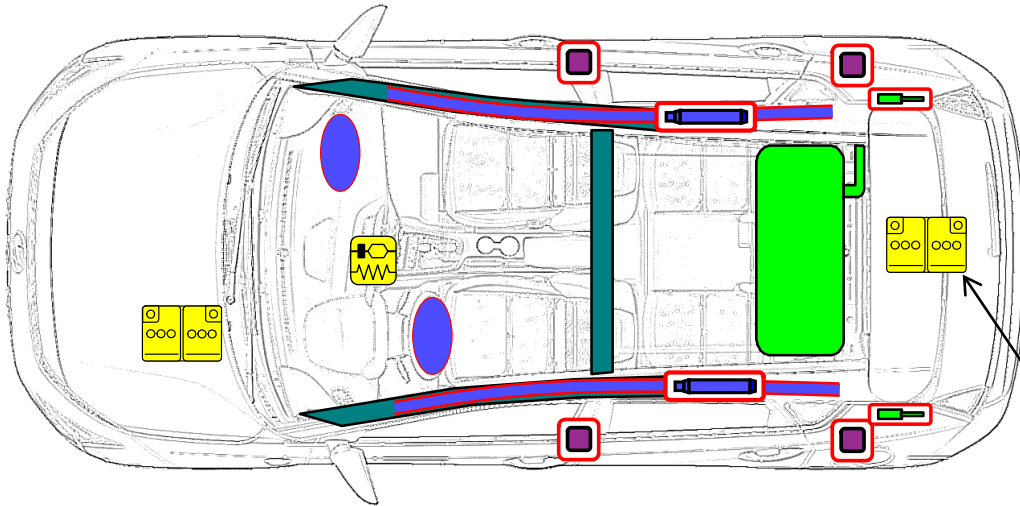

48V
Li-ion

	Airbag		Stored gas inflator		Seat belt pretensioner		SRS control unit		Pedestrian protection active system
	Automatic rollover protection system		Gas strut/Preloaded spring		High strength zone		Zone requiring special attention		
	Battery low voltage		Ultra capacitor, low voltage		Fuel tank		Gas tank		Safety valve
	High voltage battery pack		High voltage power cable/ component		High voltage disconnect		Fuse box disabling high voltage system		Ultra capacitor, high voltage

ID No.	Version No.	Version date	Page
NLH-BC3-RSM-01-202104	01	04/2021	1 of 4

1. Identification / recognition

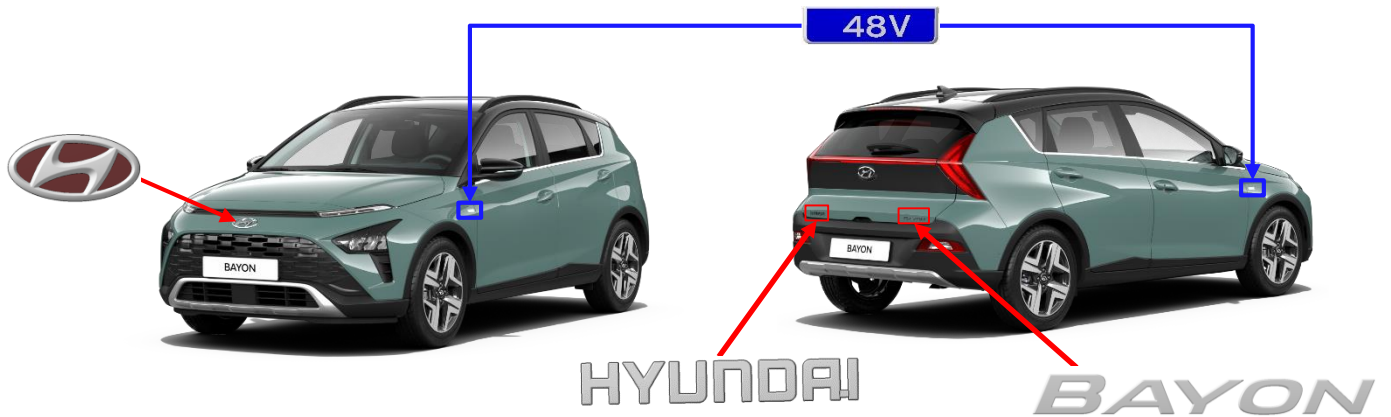

2. Immobilisation / stabilisation / lifting

■ Immobilisation



Pull up the parking brake as far as possible

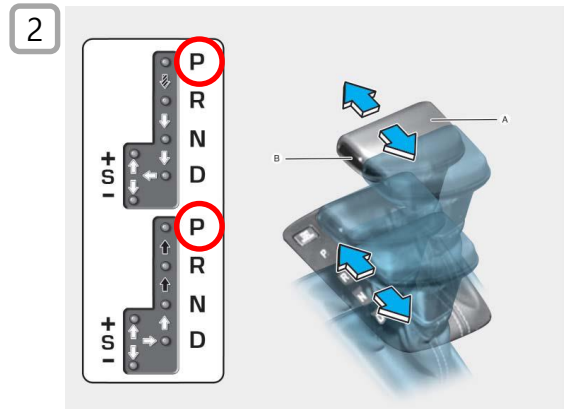

If automatic transmission: move shift lever to parking position (P)

■ Lifting positions at car underbody : ●

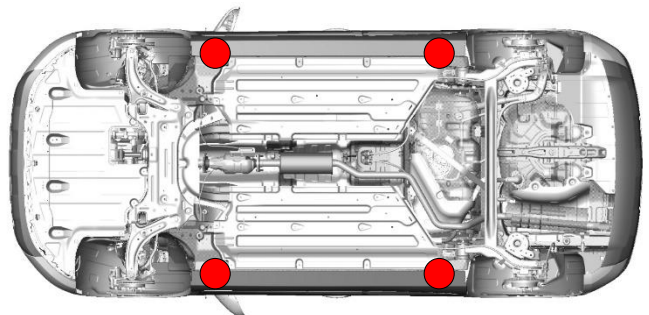
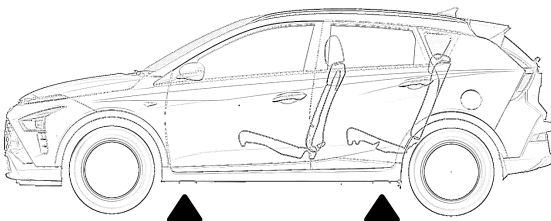

ID No.	Version No.	Version date	Page
NLH-BC3-RSM-01-202104	01	04/2021	2 of 4

3. Disable direct hazards / safety regulations

■ Access to 12V battery

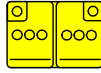

12 V

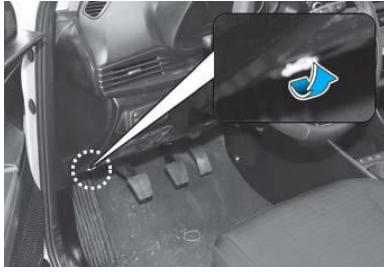

Pull the release lever to unlatch the hood. The hood should pop open slightly.

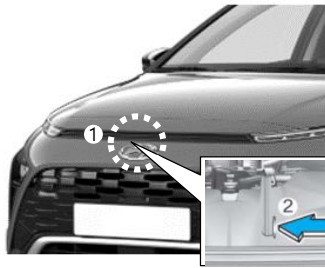

Raise the hood slightly, push the secondary latch up (1) inside of the hood center and lift the hood (2)

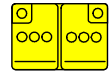
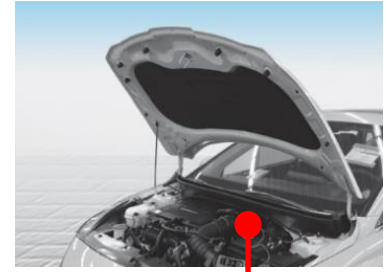

12 V

■ Disabling procedure

① Turn the ignition switch off



② Disconnect the negative(-) terminal



③ Disconnect the positive(+) terminal

■ Access to 48V battery



48 V (Li-ion)

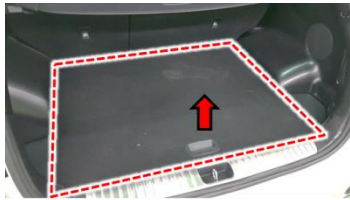

After opening the trunk, remove the luggage cover



After opening the luggage cover board remove luggage foam.



There is inlet/outlet duct and 48V battery system.

■ Disabling procedure

- ① Wait about 10 minutes after you turn off the engine.
- ② Disconnect the (-) cable from 12V battery in the hood.
- ③ Disconnect the 12V (+) cable from 48V Battery pack.
- ④ Disconnect the 48V (-) cable and (+) cable in order.
- ⑤ Disconnect the BMS EXTN wire.

4. Access to the occupants

■ Glass

1 : Laminated
2-5 : Tempered



■ Vehicle body

Hardened Steel

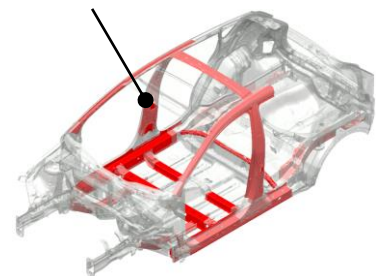

	ID No.	Version No.	Version date	Page
	NLH-BC3-RSM-01-202104	01	04/2021	3 of 4

5. Stored energy / liquids / gases / solids

■ Fuel Tank

40ℓ

■ Battery



12 V



48 V (Li-ion)

6. In case of fire

■ Gas Strut



- Risk of missile effect of tailgate.

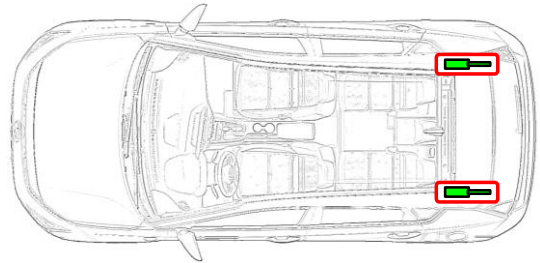

7. In case of submersion

Do not touch any of the 48V components or cables, as doing so poses an electrocution hazard. Work on the vehicle only after the vehicle has been pulled out of the water.

8. Towing / transportation / storage

■ OK

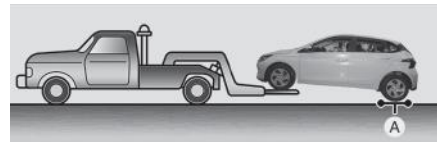
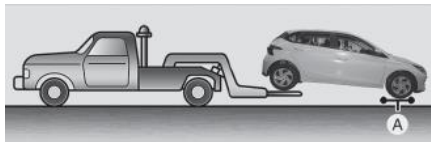
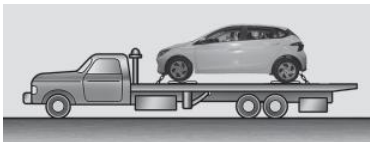

[A]: Dolly

■ NOT OK



ID No.

NLH-BC3-RSM-01-202104

Version No.

01

Version date

04/2021

Page

4 of 4