

# supersonic **r**

## Dyson Supersonic r™ Professional hair dryer User manual

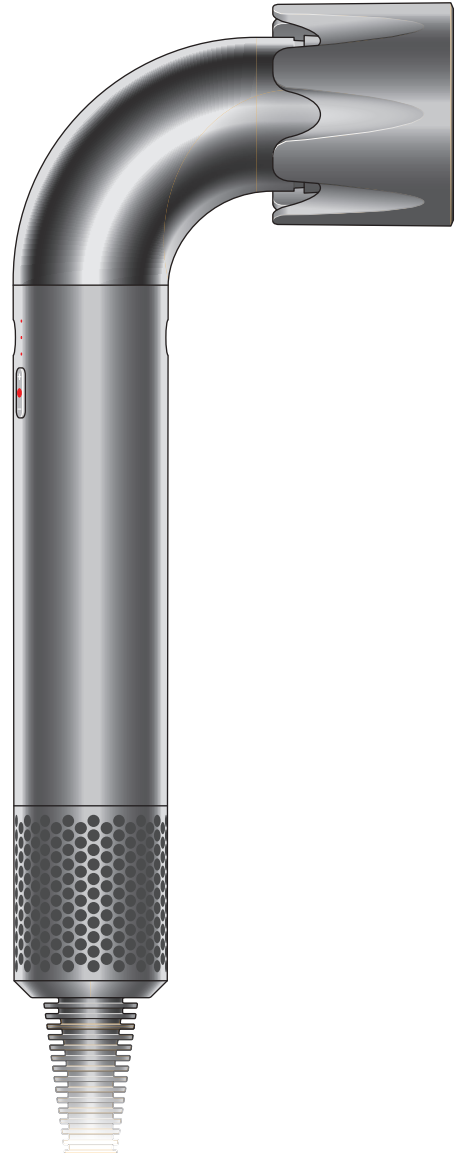

---

### Contents

In the box

Functions

Getting started

Using your Dyson Supersonic r™  
Professional hair dryer

Taking care of your machine

**dyson**

# In the box

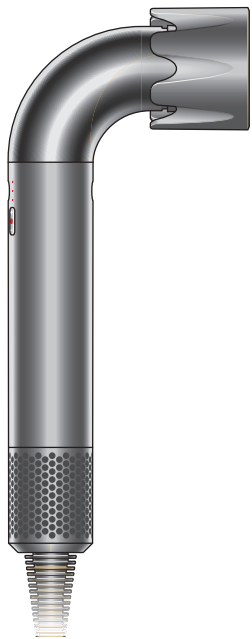

Dyson Supersonic r™ Professional hair dryer  
Dyson Supersonic r™ Professional hair dryer is Dyson's lightest<sup>1</sup>  
and most precise hair dryer.<sup>2</sup> Engineered for professional  
stylists, with five Intelligent attachments.

---

You can buy additional attachments at [www.dyson.com](http://www.dyson.com).

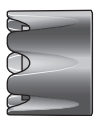

Powerful air  
attachment

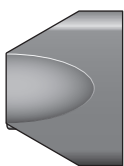

Pro concentrator

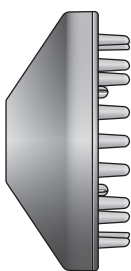

Diffuser

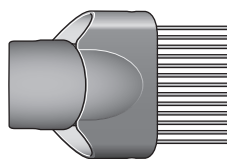

Wide-tooth comb  
attachment

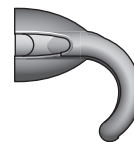

Flyaway attachment

# Functions



# Getting started

Remove machine from box

## Plug in your machine

You must fit an attachment before switching on the machine in order for your hair dryer to work.

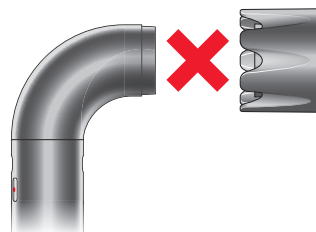
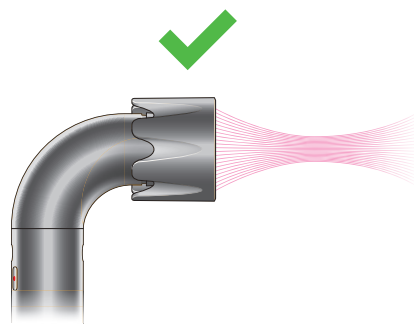

---

## Powerful air attachment

Produces high-velocity airflow to dry hair fast.

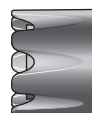

## Pro concentrator

Focuses air precisely where you need it.



## Wide-tooth comb attachment

Engineered to de-tangle and lengthen hair as it dries.

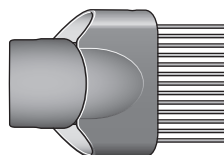

## Diffuser

Helps reduce frizz<sup>1</sup> and define curls, coils and waves.

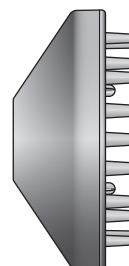

## Flyaway attachment

Attracts longer hairs and hides flyaways on finished styles, using the Coanda effect.<sup>2</sup>

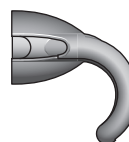

1. vs. air-dried hair. 2. For use on dry and straight[ened] hair.

# Using your hair dryer

## Settings

Intelligent attachments are preset with optimal airflow and temperature ranging, and recognise your last-used setting with Attachment learning.

## LEDs

LED colours indicate the four possible heat settings and three airflow settings.

---

### Airflow



---

### Temperature

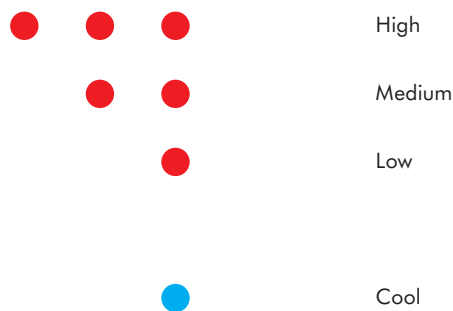

---

### Diagnostics

#### Yellow flashing LED:

Your filter needs cleaning.



#### White flashing LED:

Your filter is either absent or not fitted properly. Ensure filter is fitted correctly for your hair dryer to work.



#### White-blue LEDs flashing:

There is no attachment fitted. Your machine will not work without an attachment.



#### All three white LEDs flashing:

Press the on/off button to clear an error.



#### All three red LEDs flashing:

Switch off your machine, switch off the mains plug and unplug your plug from the socket. Then, insert the plug back in the socket, switch the mains plug on and turn your machine back on.



#### All of the white and red LEDs flashing together:

Contact Dyson at [business@dyson.co.uk](mailto:business@dyson.co.uk) 0800-345-7788  
[www.dyson.co.uk](http://www.dyson.co.uk)



To learn how to clean your filter, follow the instructions or watch the video at <https://www.dyson.co.uk/support/hair-care/hair-dryers>

# Taking care of your machine

## Cleaning your filter

To maintain optimal performance of your hair dryer, clean your filter when prompted by the yellow flashing LED light, or if you feel reduced airflow. A white light flashes when the filter is absent. We recommend that stylists build regular filter maintenance into their routine.

### Step 1

Unplug your machine from the mains electricity supply and allow to cool before cleaning your filter.

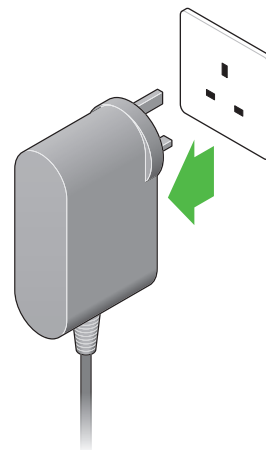

### Step 2

Remove the filter cage by sliding down the power cord and opening at the split line.

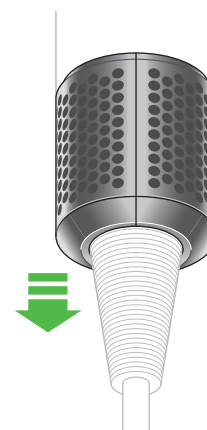

### Step 3

Slide the two filter pieces away to separate.

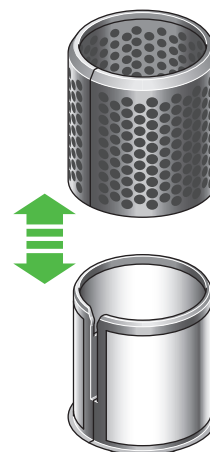

**Step 4**

Wipe away any loose, large debris such as hair strands or large dust particles, from the filter cage.

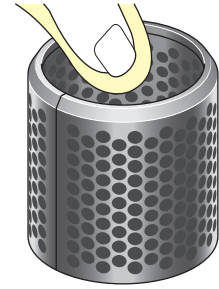

**Step 5**

Rinse the two filter parts under a warm running tap.

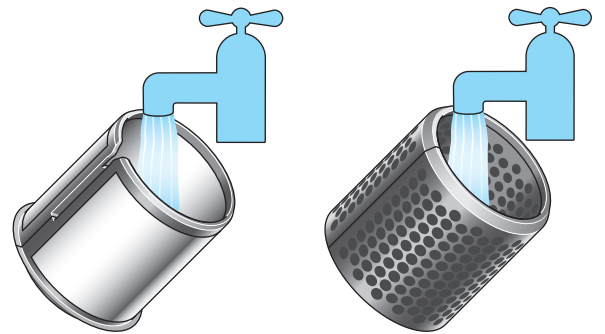

**Step 6**

Using a pea-sized amount of clarifying shampoo, lightly scrub the exterior of the inner filter cage in small, circular motions. Then, lightly scrub the interior of the inner filter cage with up and down motions before rinsing.

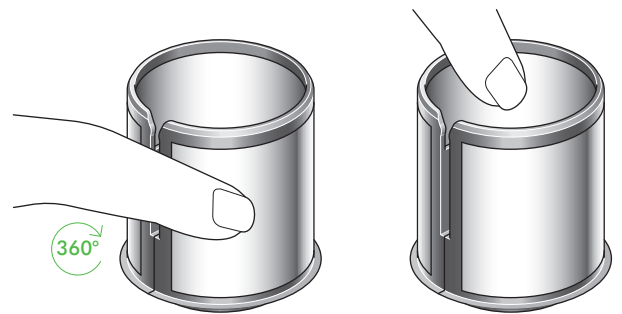

**Step 7**

Hold up to the light to ensure there is no remaining debris or dirt.



**Step 8**

Using a pinching motion, gently squeeze dry the inner filter cage with a dry paper towel.

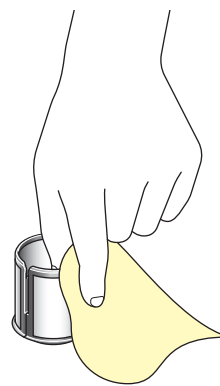

**Step 9**

Allow both filters to fully dry before proceeding.

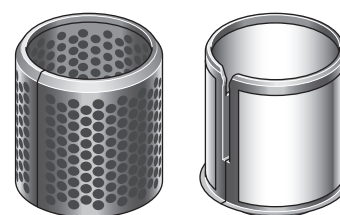

**Step 10**

Slide the inner filter back into the cage, then open at the split line and replace back on to the machine to click into place.

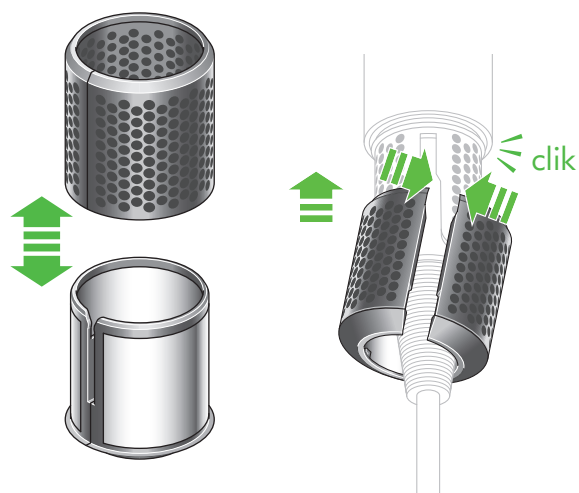

**White LED flashing:**

Your filter is either absent or not fitted properly. Ensure filter is fitted correctly for your hair dryer to work.

