



Navodila za montažo



IGRALNA HIŠICA S PESKOVNIKOM



Splošno

Preberite in shranite navodila za montažo



Ta navodila za montažo veljajo za to igralno hišico s peskovnikom. Vsebujejo pomembne informacije o varnosti in sestavljanju.

Pred začetkom sestavljanja in uporabo igralne hišice s peskovnikom skrbno in v celoti preberite navodila za montažo, zlasti varnostne napotke. Neupoštevanje teh navodil za montažo lahko povzroči hude telesne poškodbe ali škodo na igralni hišici s peskovnikom.

Navodila za montažo temeljijo na standardih in predpisih, ki veljajo v Evropski uniji. V tujini upoštevajte tudi predpise in zakone posamezne države.

Navodila za montažo shranite, da jih boste lahko uporabili pozneje. Če igralno hišico s peskovnikom izročite tretjim osebam, jim hkrati z njo obvezno izročite ta navodila za montažo.

Predvidena uporaba

Igralna hišica s peskovnikom je zasnovana izključno kot igralna hišica za otroke, stare od 3 do 14 let, s telesno težo, ki ne presega 50 kg. Pozor! Igralna hišica s peskovnikom je namenjena izključno za domačo rabo na prostem in ni primerna za javna ali gospodarska območja.

Igralna hišica ni zasnovana za skladiščenje visoko eksplozivnih ali hitro vnetljivih snovi.

Igralno hišico s peskovnikom uporabljajte le tako, kot je opisano v teh navodilih za montažo. Kakršna koli drugačna uporaba velja za neprimerno in lahko povzroči materialno škodo ali celo poškodbe oseb.

Tudi pritrjevanje tujih materialov, kot so težke verige, gugalnice ipd., velja kot nenamensko.

Izdelovalec ali prodajalec ne prevzemata nobenega jamstva za škodo, nastalo zaradi nenamenske ali napačne uporabe.

Razlaga znakov

V teh navodilih za montažo, na igralni hišici s peskovnikom ali na embalaži se uporabljajo naslednji simboli in opozorilne besede.



Ta simbol podaja koristne dodatne informacije o montaži ali uporabi.



OPOZORILO! S tem simbolom so označeni izdelki, ki niso primerni za otroke, mlajše od treh let.



Izjava o skladnosti (glejte poglavje „Izjava o skladnosti“): Izdelki, označeni s tem simbolom, izpolnjujejo vse predpise Skupnosti v Evropskem gospodarskem prostoru, ki jih je treba upoštevati.



S tem simbolom so označeni izdelki, katerih materiali izvirajo iz trajnostno upravljanjih gozdov in nadzorovanih virov.



Ne usedajte se na streho igralne hišice s peskovnikom ali ne stojte na njej. Obstaja nevarnost padca in zrušenja.

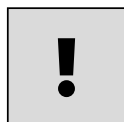

Ta simbol opozarja na pomembne informacije, ki jih je treba upoštevati med montažo.

Varnost

Razlaga napotkov

V navodilih za uporabo se uporabljajo naslednji simboli in opozorilne besede.

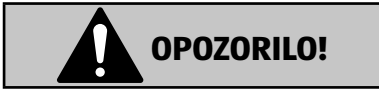

Ta opozorilni simbol/opozorilna beseda označuje nevarnost s srednjo stopnjo tveganja, zaradi katere lahko, če se ji ne izognemo, pride do smrti ali hudih telesnih poškodb.



Ta opozorilna beseda opozarja na možnost materialne škode.

Varnostni napotki

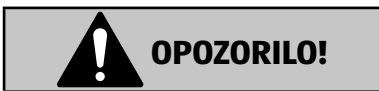

Ni primerno za otroke, mlajše od 3 let. Visoka platforma. Nevarnost padcev!



Nevarnost telesnih poškodb!

Nepravilno ravnanje z igralno hišico s peskovnikom lahko povzroči telesne poškodbe.

- Upoštevajte, da se lahko v igralni hišici s peskovnikom igrajo le otroci med 3. in 14. letom.
- Pred vsako uporabo preverite, ali so na igralni hišici s peskovnikom vidne poškodbe.
- Upoštevajte največjo obremenitev igralne hišice s peskovnikom, ki znaša 150 kg.
- Samo za hišno uporabo.
- Vsakršne spremembe na konstrukciji izvajajte le z dovoljenjem in po navodilih proizvajalca.



Nevarnost eksplozije!

Zaradi sončnega sevanja se lahko igralna hišica s peskovnikom močno segreje. Eksplozivne snovi lahko eksplodirajo, hitro vnetljive/gorljive snovi pa lahko zanetijo požar, če jih hranite v igralni hišici s peskovnikom.

- V igralni hišici s peskovnikom ne hranite nobenih lahko vnetljivih, lahko gorljivih in eksplozivnih snovi.
- V primeru požara nemudoma obvestite gasilce in poskrbite, da v igralni hišici s peskovnikom ni nobene osebe.

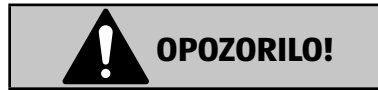

Nevarnost telesnih poškodb!

Streha igralne hišice s peskovnikom se lahko pod bremenom snega in ledu podre. Tako so lahko osebe v notranjosti igralne hišice s peskovnikom huje poškodovane.

- Pravočasno odstranite led in sneg s strehe igralne hišice s peskovnikom. Nevarna obremenitev zaradi snega nastopi, če višina sloja pri suhem snegu presega 36 cm, pri mokrem snegu 10 cm ali 5,5 cm pri ledu.
- Pozimi zaklenite igralno hišico s peskovnikom in opremo pospravite v stanovanjsko hišo.



Nevarnost poškodb!

Nepravilno ravnanje z igralno hišico s peskovnikom lahko povzroči poškodbe na igralni hišici.

- Pri izvajanju popravil pazite, da ne spremenite konstrukcije igralne hišice s peskovnikom in s tem postane nevarna.



Da se izognete zlorabi, tatvini in vlomu, opremite igralno hišico s peskovnikom z varnimi zaklepi. Pri zaklepanju igralne hišice s peskovnikom se prepričajte, da ni v njej nobene osebe in da je hišica ustrezno in varno zaprta.

Preverite igralno hišico s peskovnikom in vsebino ob dobavi

1. Posamezne dele vzemite iz embalaže.
2. Preverite, ali so v kompletu vsi deli (glejte **sl. A in B**).
3. Preverite, ali so posamezni deli morda poškodovani. Če so, igralne hišice s peskovnikom ne sestavljajte. Obrnite se na izdelovalčev servis na naslovu, navedenem na garancijskem listu.

Mesto postavitve

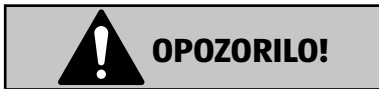

Nevarnost telesnih poškodb!

Neprimerno mesto za postavitve igralne hišice s peskovnikom in podlaga z nezadostnim blaženjem udarcev lahko povzročita resne poškodbe.

- Pripravite podlago za igralno hišico s peskovnikom tako, da material za blaženje udarcev nasujete vsaj 2 m čez rob igralne hišice s peskovnikom in robove njenih igralnih elementov v vse smeri. Material za blaženje udarcev štiti pri padcih pred hudimi poškodbami.



Po potrebi je postavitve igralne hišice s peskovnikom urejena z gradbenimi predpisi. Dovoljenje za postavitve vam lahko upravni organ pri kršitvah pogojev postavitve odvzame, tako da ste primorani k razstavljanju igralne hišice s peskovnikom.

- Pred postavitvijo se posvetujte s pristojnim upravnim organom.
- Upoštevajte veljavne predpise.

Glede na naslednja merila poiščite primeren prostor za postavitve igralne hišice s peskovnikom:

- Igralno hišico s peskovnikom sestavite le na ravni podlagi.
- Igralne hišice s peskovnikom ne sestavljajte na trdi podlagi, npr. na asfaltu, kamnitih ploščah ali betonu.
- Poskrbite za podlago za blaženje sunkov na območju padcev okrog igralne hišice s peskovnikom, tobogana, lestve in plezalne stene.
- Igralno hišico s peskovnikom sestavite na mestu, ki je zaščiteno pred vetrom.
- Igralno hišico s peskovnikom usmerite tako, da se tobogan zaradi sončnega sevanja ne more močno segreti.
- Upoštevajte najmanj 2 m varnostne razdalje do drugih struktur ali ovir. To olajša sestavljanje in lahko reši življenje v primeru požara.
- Na enem mestu sestavite največ eno igralno hišico s peskovnikom.

- Na območju padcev razgrnite po tleh material, ki blaži udarce. Sem na primer spadajo naslednji materiali: Zastirka iz lubja, lesni sekanci, pesek in prod (debelina sloja najmanj 30 cm).
- Uporabite lahko tudi blazine za zaščito pred padcem za višino padca najmanj 1,2 m.
- Upoštevajte, da mora cona območja padca na vseh straneh znašati najmanj 2 m.

Temelj

Igralna hišica s peskovnikom mora biti trdno pritrjena na podlago. Le tako je mogoče preprečiti dviganje ali prevračanje nosilnih elementov pri normalni uporabi ali predvidljivi napačni uporabi. Za igralno hišico s peskovnikom je primeren betonski temelj.

- Za pritrjevanje uporabljajte talne tulce, ki so priloženi vsebini kompleta.
- Pritrditev prilagodite obstoječim talnim razmeram/sestavi.
- Sidranja namestite na enaki ravni, kot je talna površina ali pod njo, tako da prevračanje igralne hišice s peskovnikom ni mogoče.

Napotki za postavitvev



OPOZORILO!

Nevarnost telesnih poškodb!

Če se teh navodil za montažo ne držite natančno, lahko pride do napak, ki so lahko smrtno nevarne.

- Igralno hišico s peskovnikom postavljajte z najmanj dvema odraslima osebama.
- Med postavljanjem nosite zaščitne rokavice, očala in čevlje.
- Pri nameščanju zgornjih delov igralne hišice s peskovnikom se medsebojno dobro zavarujte, zlasti ko stojite na lestvi.
- Ne stopajte na streho igralne hišice s peskovnikom. Obstaja nevarnost padca in zrušenja.
- Pazite, da iz lesa ne molijo ven nobeni žebliji, vijaki ipd. To lahko povzroči hude telesne poškodbe.



OPOZORILO!

Nevarnost telesnih poškodb!

Med uporabo je igralna hišica s peskovnikom izpostavljena spremenljivim obremenitvam. Če ni trdno pritrjena na podlago, obstaja nevarnost poškodb zaradi prevračanja igralne hišice s peskovnikom.

- Pritrditev naj bo na enaki ravni s talno površino ali pod njo.



OPOZORILO!

Nevarnost telesnih poškodb!

Igralna hišica s peskovnikom ima lahko ostre robove. Če robov ne zaoblite, se lahko urežete.

- Ostre robove zaoblite s pilo in/ali finim brusnim papirjem.



OPOZORILO!

Nevarnost telesnih poškodb!

Med postavitvijo obstaja posebna nevarnost poškodb otrok in oseb, z zmanjšanimi fizičnimi, zaznavnimi ali duševnimi sposobnostmi. Te osebe ne bodo mogle pravilno oceniti nevarnosti.

- Pazite, da otroci in osebe z zmanjšanimi telesnimi, zaznavnimi ali duševnimi sposobnostmi ne bodo prisotni med sestavljanjem igralne hišice s peskovnikom.

OBVESTILO!

Nevarnost poškodb!

Material les se odziva na vremenske vplive. Vlaga lahko igralno hišico s peskovnikom poškoduje, kajti les ni obdelan. Če igralne hišice s peskovnikom ne premazujete, lahko pride do deformacij, hišica ne bo lepa na videz in lahko postane nestabilna.

- Posamezne dele igralne hišice s peskovnikom pustite dva dni pred sestavljanjem zunaj, da se lahko les privadi temperaturi okolice in zračni vlagi.
- Igralno hišico s peskovnikom postavite v suhem in ne prevročem oz. ne preveč sončnem vremenu.
- Igralno hišico s peskovnikom po sestavljanju obdelajte z okolju prijazno lazuro ali podobno snovjo.
- Pri izbiranju barv pazite, da so barve primerne za igrače.

Korak za korakom upoštevajte navodila za sestavljanje v določenem vrstnem redu in zelo vestno.

Uporaba

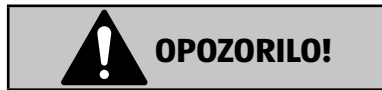

Nevarnost telesnih poškodb!

Nepravilno ravnanje z igralno hišico s peskovnikom lahko povzroči telesne poškodbe.

- Otroke pustite, da se igrajo v igralni hišici s peskovnikom, samo če je popolnoma suha in tako v njej ne drsi.
- Otrokom ne dovolite igranja v igralni hišici s peskovnikom pri nizkih temperaturah. Ob zmrzali tla zmrznejo. Zaradi tega obstaja pri padcu povečana nevarnost telesnih poškodb.
- Pazite, da otroci ne bodo plezali na streho igralne hišice s peskovnikom. Obstaja nevarnost padca in zrušenja.
- Na tobogan ne zlivajte vode, da bi se hitreje spuščali po njem.
- Otrokom ne dovolite igranja v igralni hišici s peskovnikom, če nosijo obleke z vrvicami, vezalkami ali široka oblačila in nakit. Takšna oblačila predstavljajo morebitno nevarnost zadušitve.
- Prepričajte se, da se otroci po toboganu spuščajo le, če je tobogan suh.
- Poskrbite, da otroci ne bodo viseli na lesenih konstrukcijskih delih z glavo navzdol.
- Prepričajte se, da otroci ne morejo zaklepati drug drugega v igralno hišico.
- Ko so otroci v igralni hišici s peskovnikom, jih ves čas nadzirajte.

Z uporabo se igralna hišica s peskovnikom bolj ali manj obrablja. Les se odziva na vplive okolja in lahko nastanejo razpoke ali pride do odstopkov. Zaradi tega lahko sčasoma nastanejo pomanjkljivosti, ki so lahko za otroke zelo nevarne.

- Pred vsakim začetkom igre preverite naslednje točke:
 - Ali so vsi vijačni spoji trdni?
 - Ali prihaja pri posameznih lesenih delih do drobljenja?
 - Ali so na posameznih delih vidne poškodbe?
 - Ali je pritrđitev še nepoškodovana in primerna?
- Pritegnite razrahljane vijačne spoje.
- Ogradite igralno hišico s peskovnikom, če odkrijete okvarjene dele in jih pred naslednjo uporabo zamenjajte.
- Preverite odmike med naoknicami/okvirjem in vrati/transkimi stenami ter jih znova nastavite, če je minimalni odmik manjši od 12 mm.
- Ob zmrzali zaprite igralno hišico s peskovnikom in spravite opremo (npr. tobogan) v hišo oz.

okolico brez zmrzali.

Čiščenje in nega

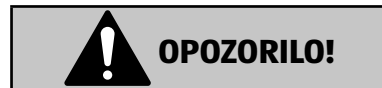

Nevarnost telesnih poškodb!

Igralna hišica je skozi vse leto izpostavljena vremenskim vplivom, zaradi česar nastajajo alge in mahovi, ki zadržujejo vlago. Les postane spolzek in trhel. Pri spodrsavanju lahko pride do hudih telesnih poškodb.

- Redno odstranjujte alge in mah.

OBVESTILO!

Nevarnost poškodb!

Nepravilno ravnanje z igralno hišico s peskovnikom lahko povzroči poškodbe.

- Ne uporabljajte agresivnih čistilnih sredstev, krtač s kovinskimi ščetinami ter ostrih ali kovinskih predmetov za čiščenje, kot so noži, trde lopatice in podobno. Ta lahko poškodujejo površine.
- Za čiščenje ne uporabljajte parnega ali visokotlačnega čistilnika. V nasprotnem primeru lahko pride do poškodb na igralni hišici s peskovnikom. Les postane hrapav in nastanejo trske.

Če je igralna hišica s peskovnikom v bližini velikih dreves ali močno prometnih cest, se hitreje umaže kot na zračnih vrtovih ali ob manj prometnih cestah. Na igralni hišici s peskovnikom nastaja mikrofilm, ki je substrat za alge.

1. Grobo umazanijo in pesek odstranite z metlo.
2. Les zdrgnite s čisto vodo in malo sredstva za pomivanje ali z jedrnim milom, da odstranite mah in alge. Za to uporabite krtačo za ribanje. Takoj zatem temeljito sperite les s čisto vodo.
3. Tobogan **29** in oprijemala **65** plezalne stene **14** očistite s krpo. V ta namen uporabite toplo vodo in blago čistilo.
4. Igralna hišica s peskovnikom naj se posuši na zraku. Šele ko je igralna hišica s peskovnikom suha, jo lahko otroci znova uporabljajo. Sicer je spolzka.

Čiščenje in vzdrževanje

OBVESTILO!

Nevarnost poškodb!

Zaradi nepravilnega ravnanja z igralno hišico s peskovnikom lahko pride do poškodb igralne hišice.

- Redno preverjajte, ali je igralna hišica s peskovnikom morda poškodovana, ali ima zrahljane vijačne spoje ter ali so na njej razpoke in špranje.
- Igralne hišice ne negujte z drsečimi ali strupenimi premazi.
- Za osvežitev premaza uporabljajte enake lake ali lazure kot pri prvem premazu.

Na začetku vsake sezone uporabe ter vsaj enkrat mesečno v sezoni izvajajte naslednje vzdrževanje, četudi v tem času igralna hišica ni bila uporabljena:

- Preglejte igralno hišico s peskovnikom in pritr-ditev glede obrabe in poškodb.
- Pri poškodbah ali obrabi zaprite igralno hišico s peskovnikom in pred nadaljnjo uporabo zame-njajte dele s primernimi izvirnimi nadome-stnimi deli.
- Preverite, ali so vse matice in vijaki trdno priviti in jih po potrebi pritegnite.
- Pred vsako uporabo igralne hišice s peskovni-kom odstranite iveri.
- Redno naoljite tečaje oken in vrat.
- Vsaj vsako drugo leto osvežite premaz lesa.

Tehnični podatki

Model:	Hofer 2019
Starostna omejitev:	za otroke 3–14 let
Število oseb:	največ 3 otroci s težo, manjšo od 50 kg
Največja obremenitev:	150 kg
Material	
Osrednji del igralne hišice s peskovnikom:	nordijska smreka, naravna/ neobdelana
Strešna lepenka:	-
Talni tulci:	jeklo, pocinkano
Tobogan:	plastika
Dimenzije	
Skupaj (Š × G × V):	370 × 252 × 276 cm
Mere izdelka (Š × G × V):	123 × 172 × 270 cm
Igralna hišica s peskovnikom (Š × G):	123 × 103 cm
Debelina stene:	14 mm
Plezalna stena (Š × V):	63 × 139 cm
Debelina plezalne stene:	20 mm
Dolžina tobogana:	228 cm
Peskovnik (Š × G × V):	120 × 172 × 21 cm
Terasna plošča (Š × G):	123 × 69 cm
Enosmerna vrtljiva vrata (Š × V):	47 × 99 cm
Številka izdelka:	59912126

Izjava o skladnosti



Izjavo o skladnosti EU lahko zahtevate na naslovu, ki je naveden na priloženem garancijskem listu.

Odlaganje med odpadke

Odlaganje embalaže med odpadke



Embalažo zavrzite med odpadke ločeno po vrstah materialov. Lepenko in karton oddajte med odpadni papir, folije pa med sekundarne surovine.

Odlaganje igralne hišice s peskovnikom med odpadke

- Igralno hišico s peskovnikom zavrzite v skladu s predpisi in zakoni, ki veljajo v vaši državi.

Sestavljanje

Igralno hišico s peskovnikom sestavljajte z vsaj še eno odraslo osebo.

Za montažo potrebujete naslednje pripomočke:

- gumijasto kladivo,
- kladivo,
- kladivo z razcepom,
- žago lisičji rep,
- križni izvijač,
- dvojni ključ, 10 mm,
- akumulatorski vijačnik,
- univerzalni (olfa) nož,
- svinčnik,
- vodoobstojno lepilo za les,
- merilni trak,
- vodno tehtnico,
- lestev,
- kombinirane klešče.

Navedeni deli niso priloženi ob nakupu.



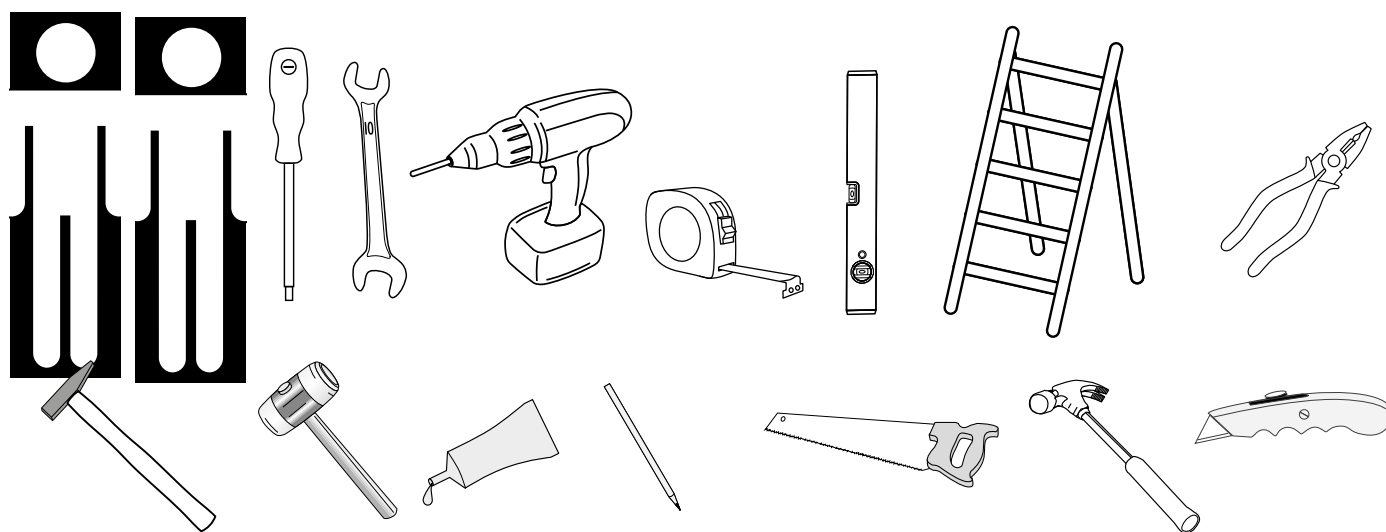



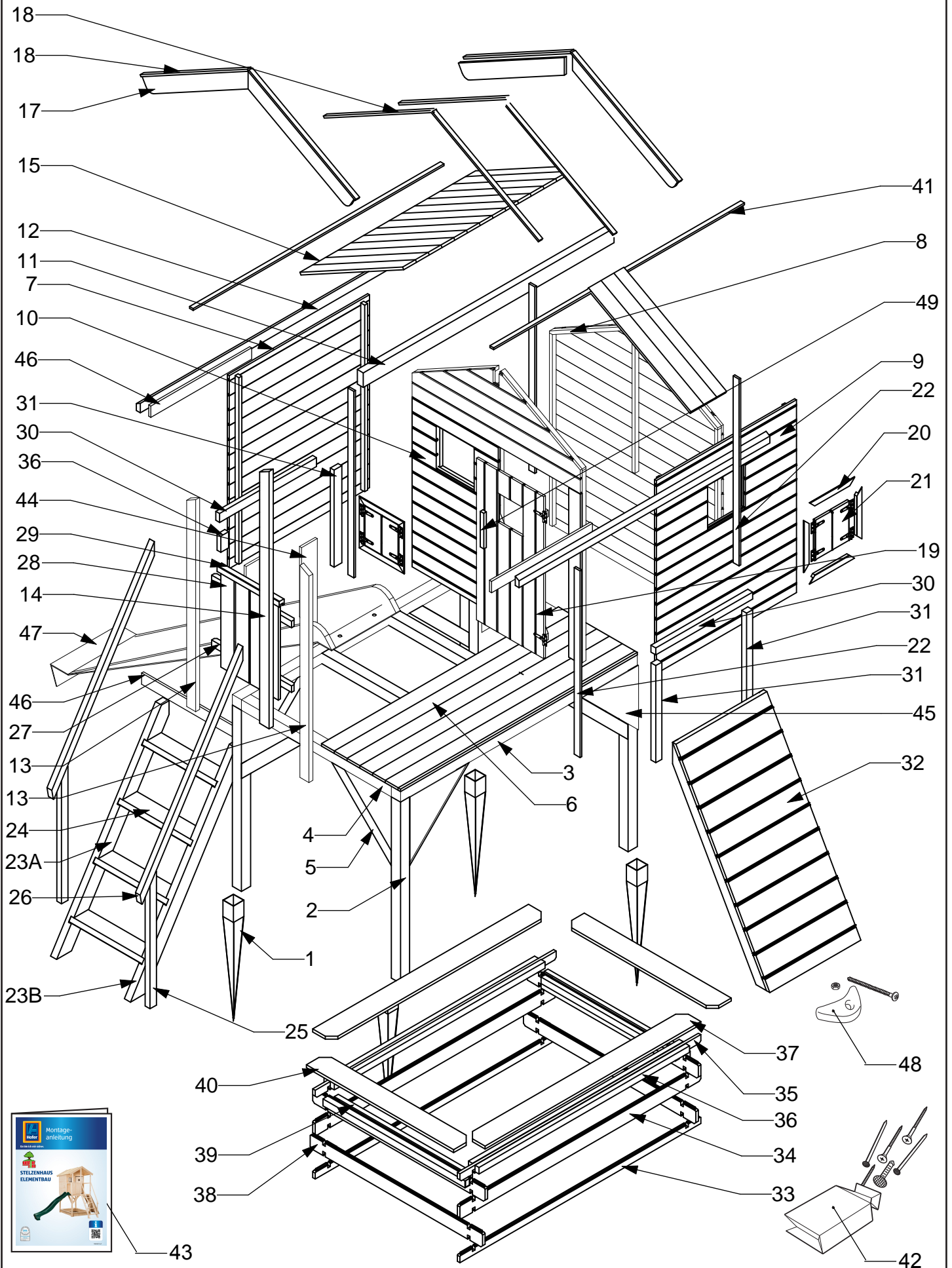





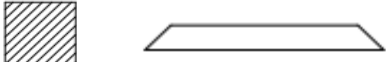

Igralne hišice s peskovnikom ne sestavljajte v dežju ali žgočem soncu.

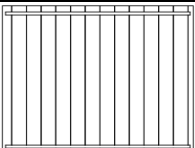
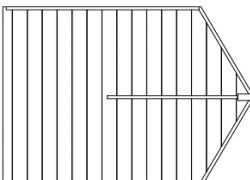
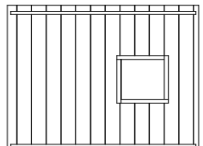
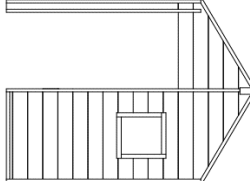







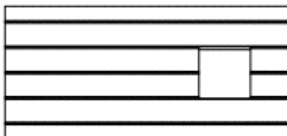



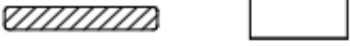







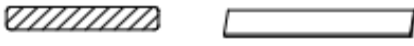

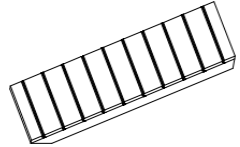

Vsebina kompleta











Vsebina kompleta

1.			4X
2.		65x65x1120	4X
3.		65x65x1690	2X
4.		65x65x1070	4X
5.		65x65x580	8X
6.		15x99x1690	14X
7.		1000x1207	1X
8.		1200x1531	1X
9.		1000x1207	1X
10.		1200x1511	1X
11.		43x90x1790	1X
12.		28x58x1790	2X
13.		28x58x1310	2X
14.		28x65x1590	1X
15.		15x99x836	40X
17.		15x95x850	4X
18.		12x26x860	8x
19.		478x990	1X

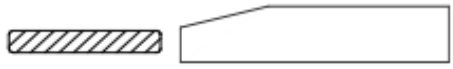
Vsebina kompleta

20.		18x38x320	8X
21.		15x95x210	4X
22.		12x42x1153	4X
23.A		43x90x1441	1X
23.B		43x90x1441	1X
24.		27,6x120x508	4X
25.		34x46x825	2X
26.		34x46x1383	2x
27.		27,6x40x510	2X
28.		15x95x600	4X
29.		35x35x445	1X
30.		34x46x690	2X
31.		34x46x600	4x
32.		1375X650	1x
33.		18X52X1710	2x
34.		18X98X1710	2x
35.		18X52X1710	2x
36.		28X40X1494	4x
37.		18,5X120X1530	2x
38.		18X98X1230	4x
39.		28X40X958	4x
40.		18,5X120X1050	2x
41.		12X26X1790	2x

Vsebina kompleta

42.		Montagematerial	1X
43.		Montageanleitung	
44.		18,5x120x680	2X
45.		3X390X390	8x
46.		15x65x720	3X
47.		Rutsche	1X
48.		Klettersteine	1 Set
49.		19x25x220	1X

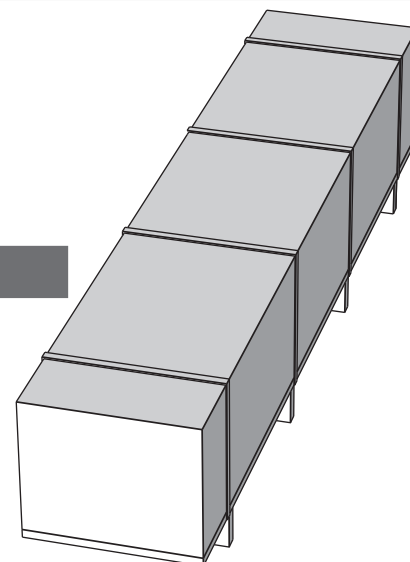
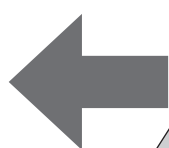
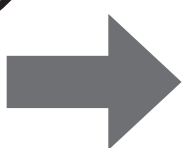
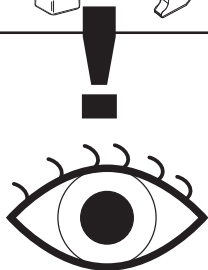
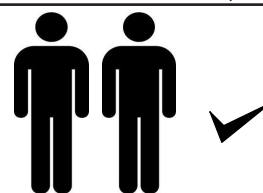
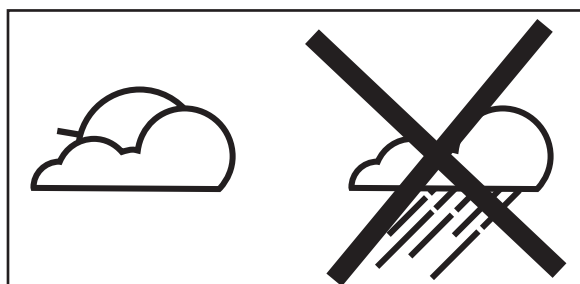
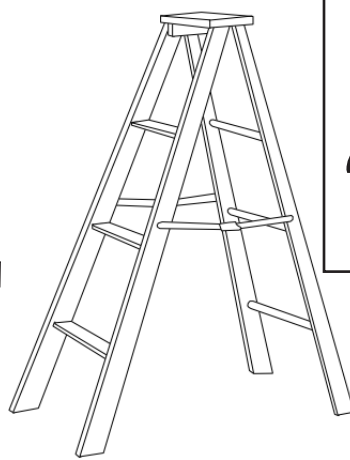
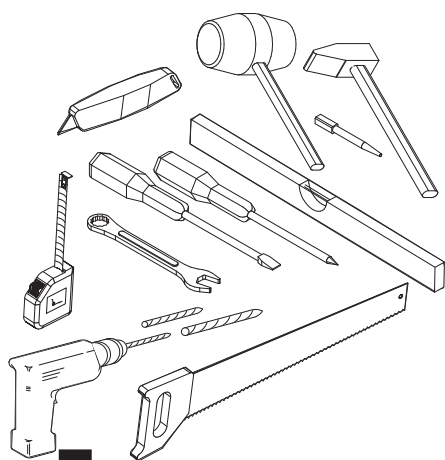

1

A

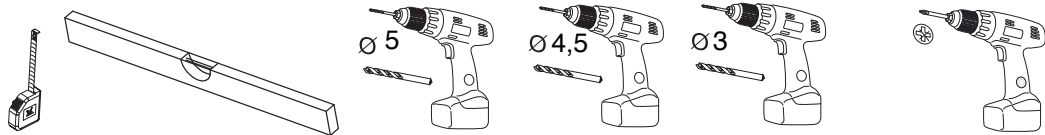

POS

- 2 65x65x1120 4X
- 3 65x65x1690 2X
- 4 65x65x1070 4X
- 5 65x65x600 8X

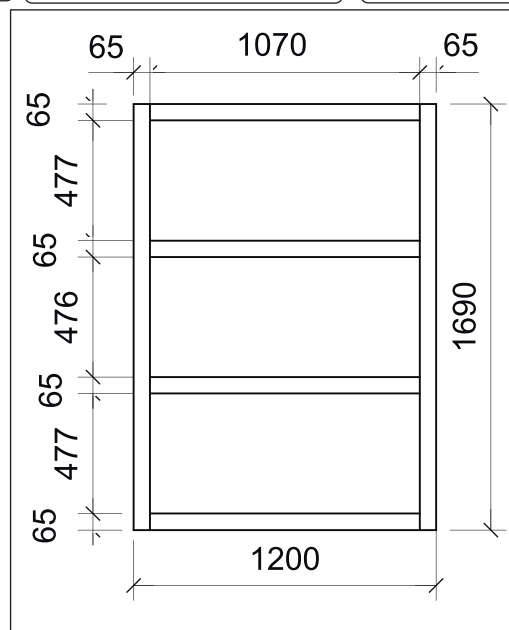
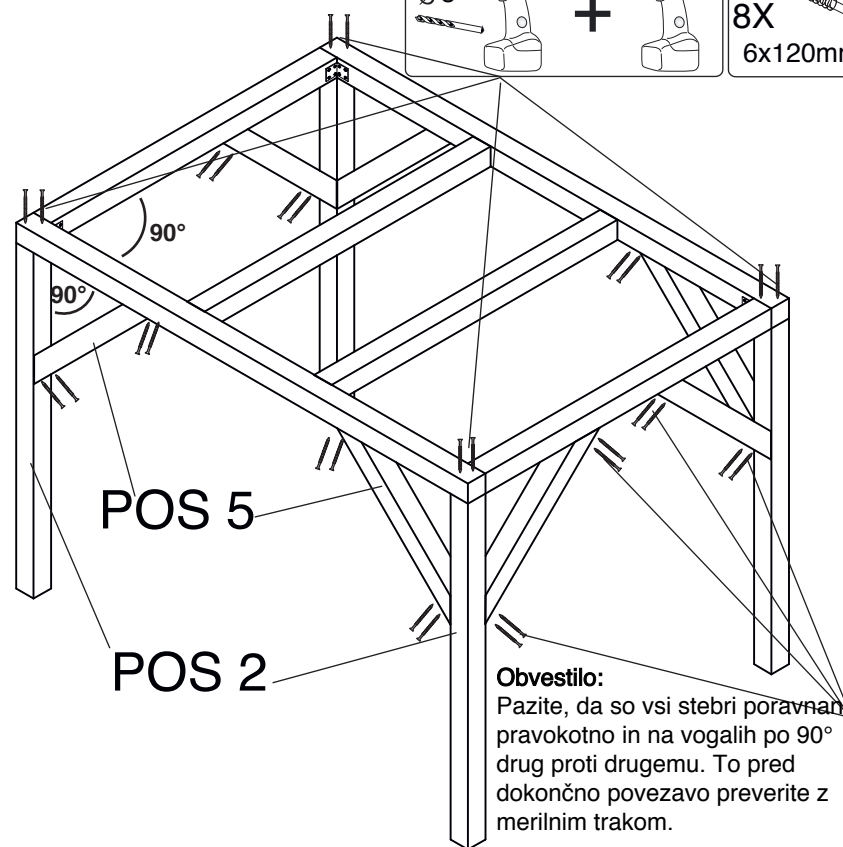
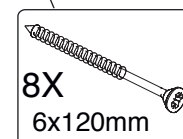
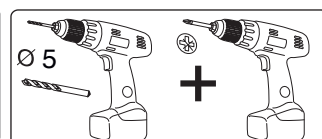
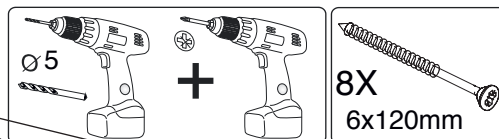
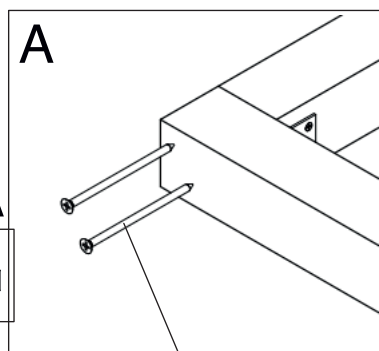
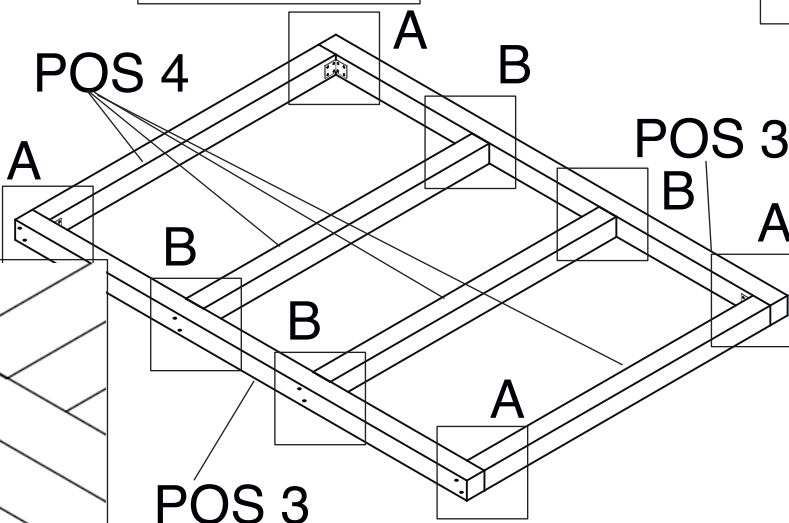
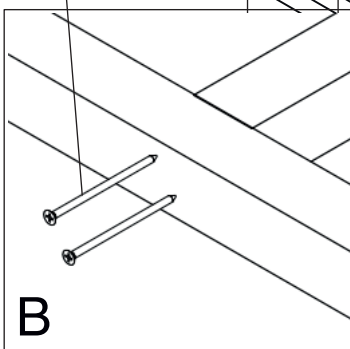
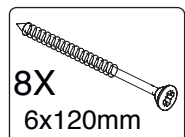
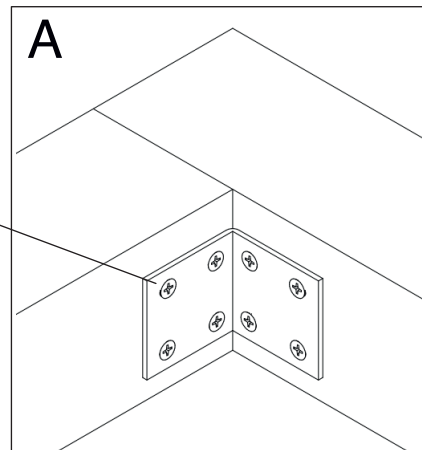
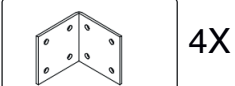
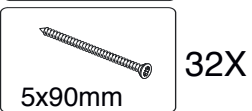
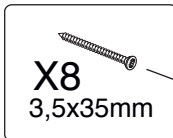
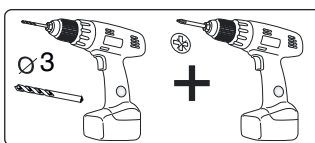
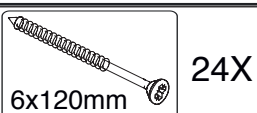

Obvestilo:
 Pazite, da so vsi stebri poravnani pravokotno in na vogalih po 90° drug proti drugemu. To pred dokončno povezavo preverite z merilnim trakom.

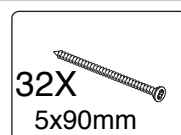
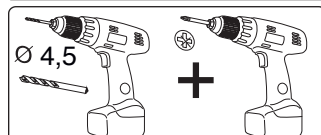

2

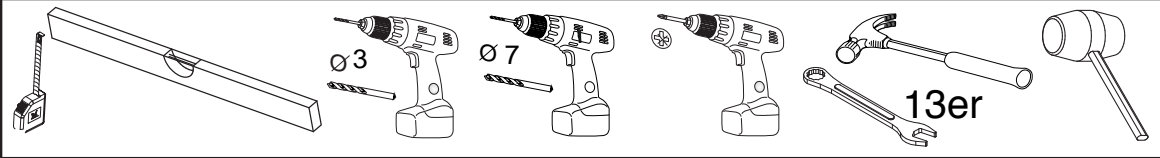

POS

- 1 4X
- 45 8X
- 33 18x52x1710 2X
- 38 18x98x1230 2X

- 48X 3,5x25mm
- 16X 8x35mm

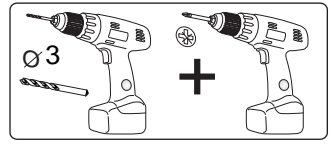

- 12X 3,5x25mm

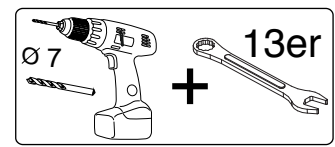
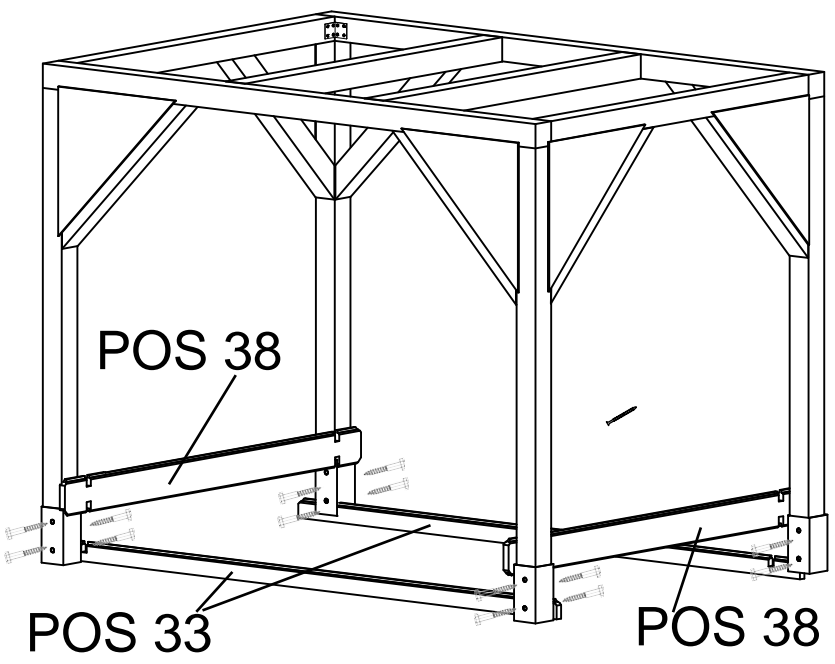
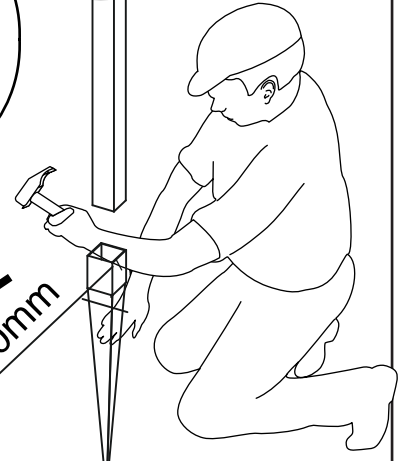
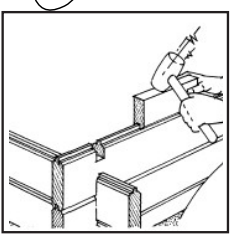
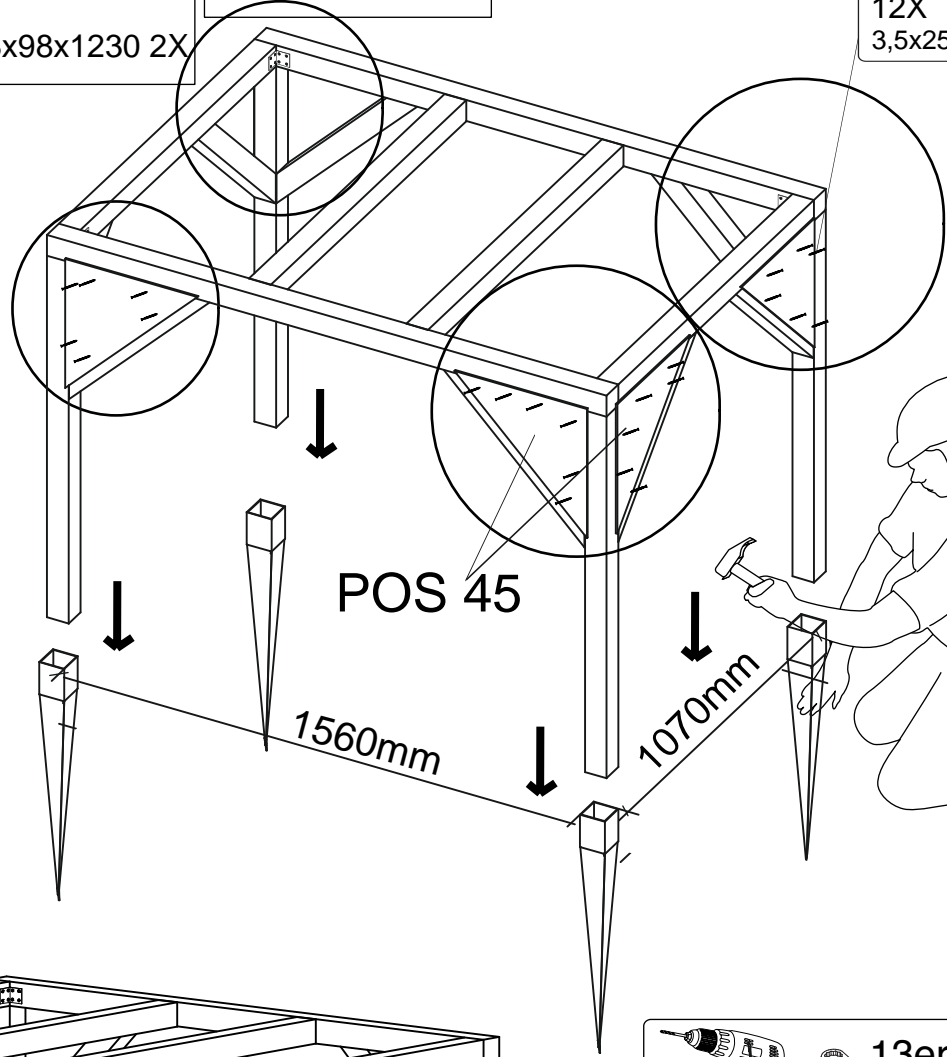

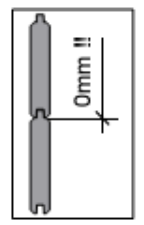
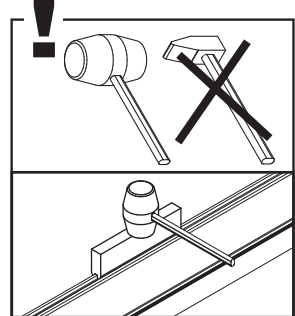

- 16X 8x35mm

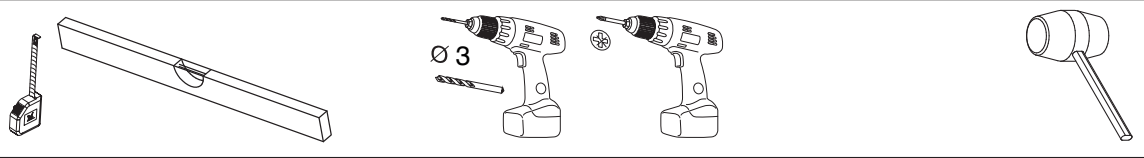

3

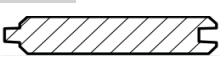
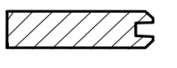
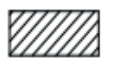

POS

- 34  18x98x1710 2X
- 35  18x52x1710 2X
- 36  28x40x1494 4X
- 38  18x98x1230 2X
- 39  28x40x958 4X

 14X
3,5x35mm

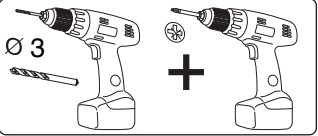
 +

 X3
3,5x35mm

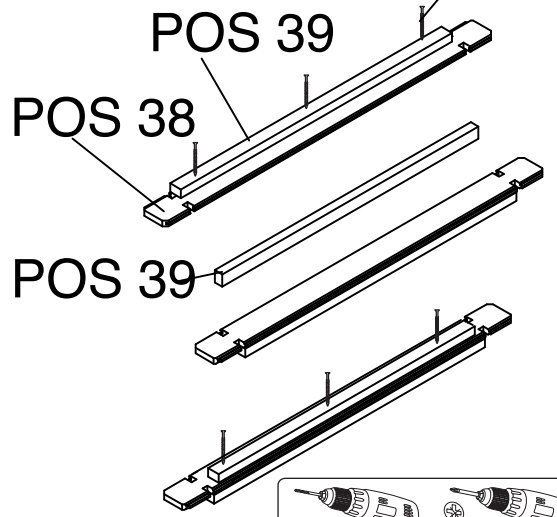
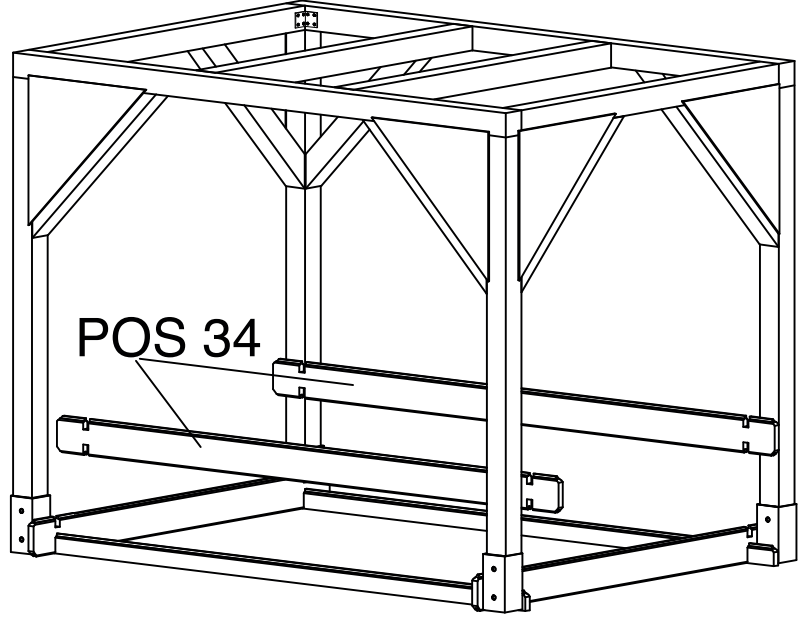

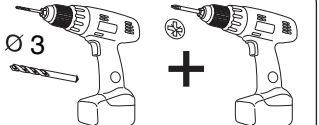
 +

 X4
3,5x35mm

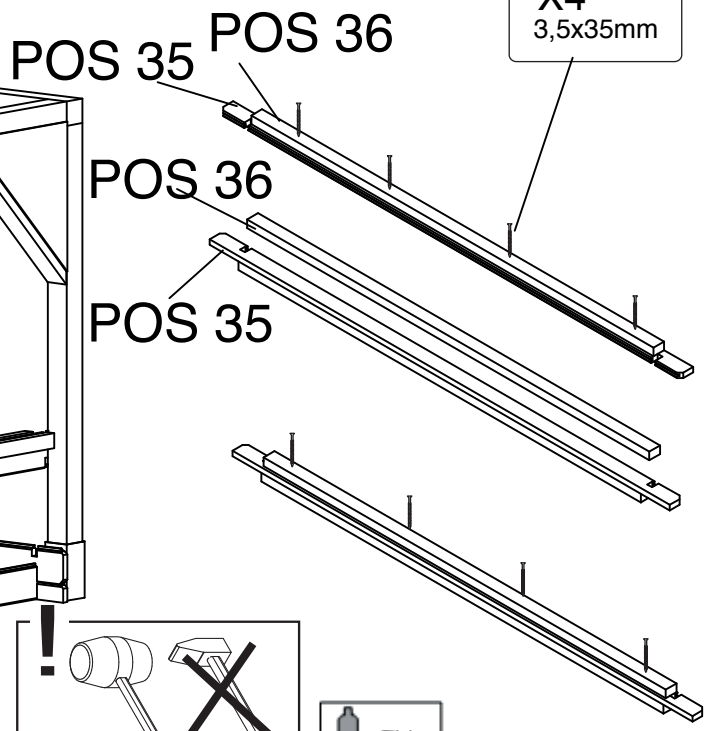
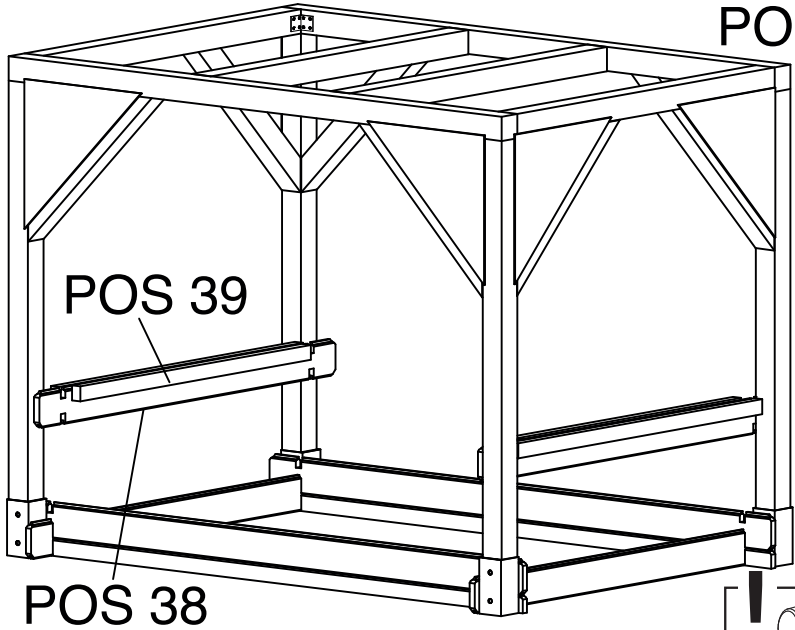

POS 38

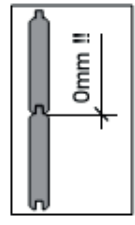
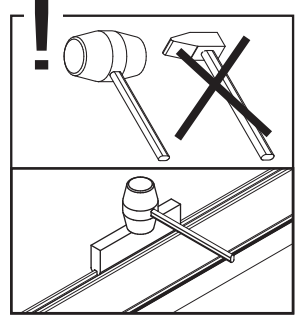
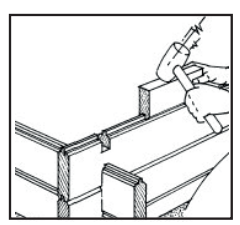

4

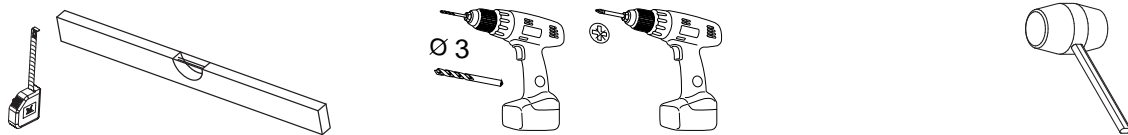

POS

35  18x52x1710 2X

36  28x40x1494 4X

37  18,5x135x1540 2X

40  18,5x135x1050 2X

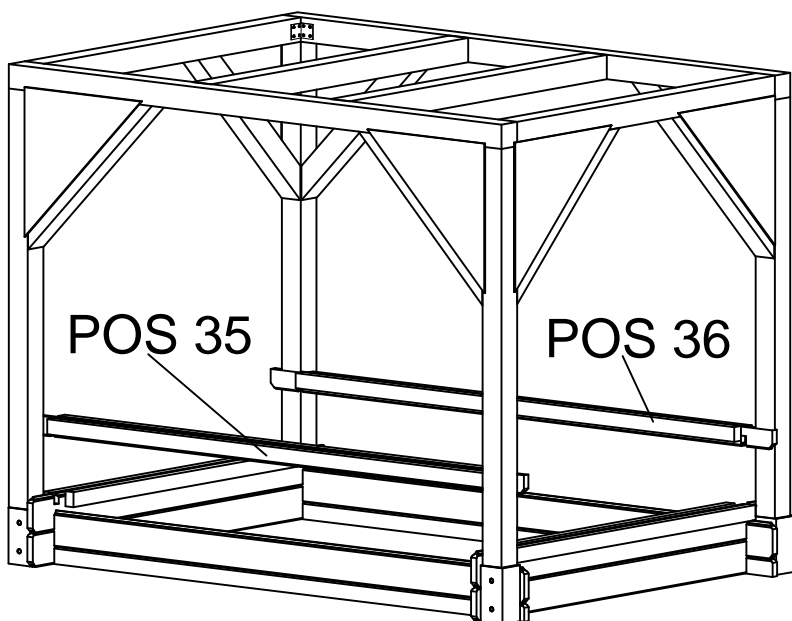
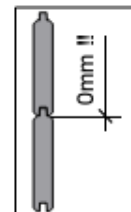
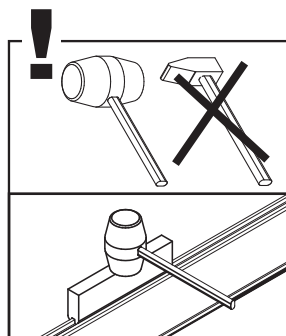
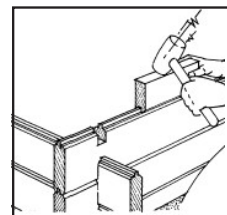
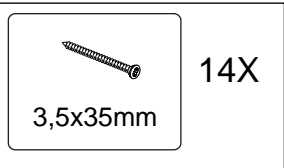

POS 35

POS 36

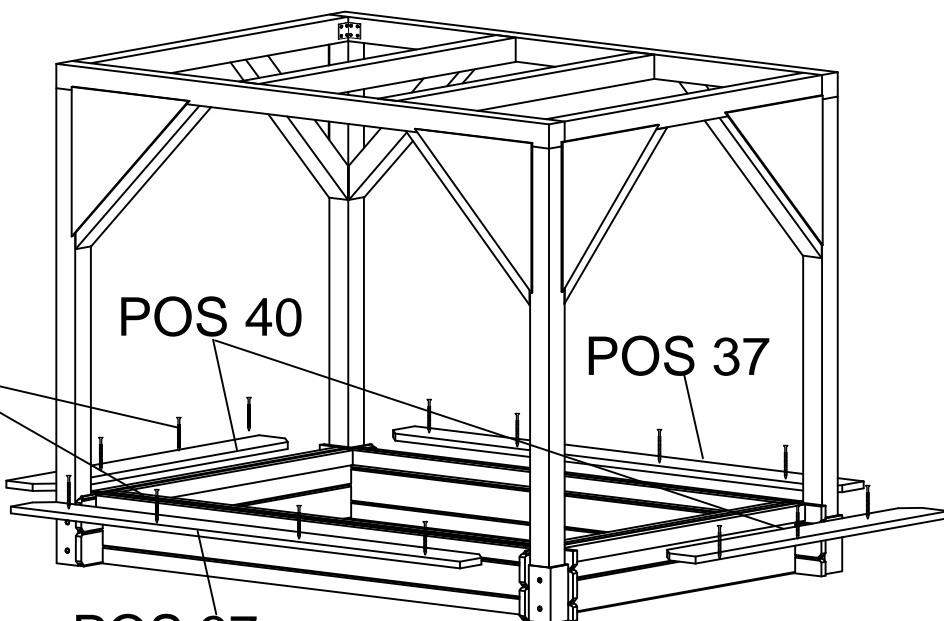
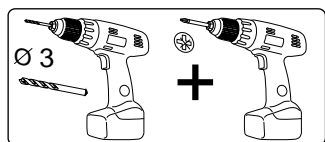

POS 40

POS 37

POS 37

Obvestilo:

Poravnajte peskovnik sredinsko s spodnjo konstrukcijo in ga napolnite s peskom, da ga več ni mogoče premikati.

5

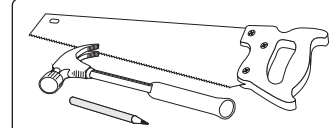
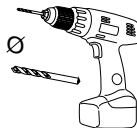
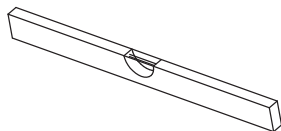

POS

6  15x99x1690 14X

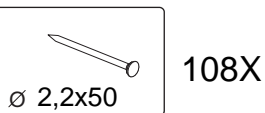

A POS 6

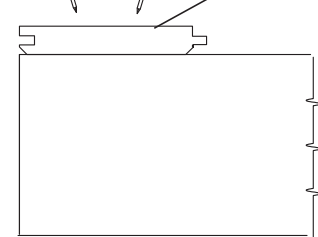

B POS 6

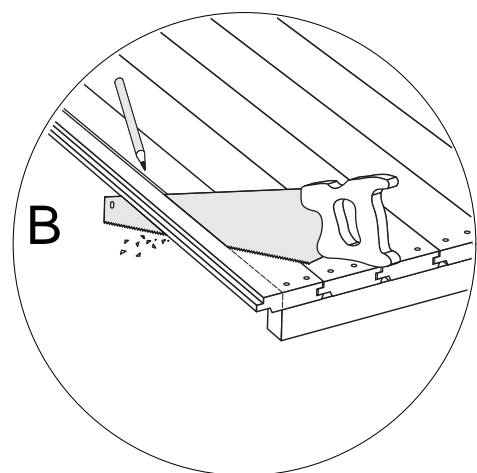
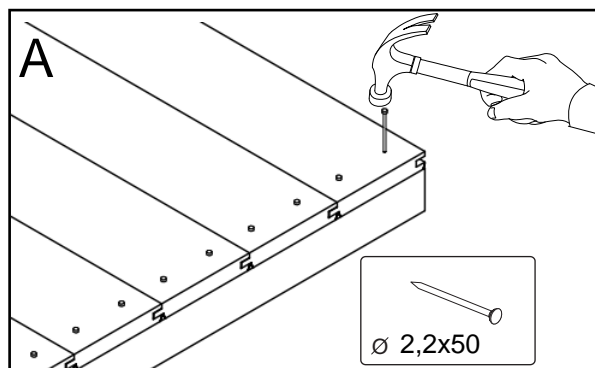
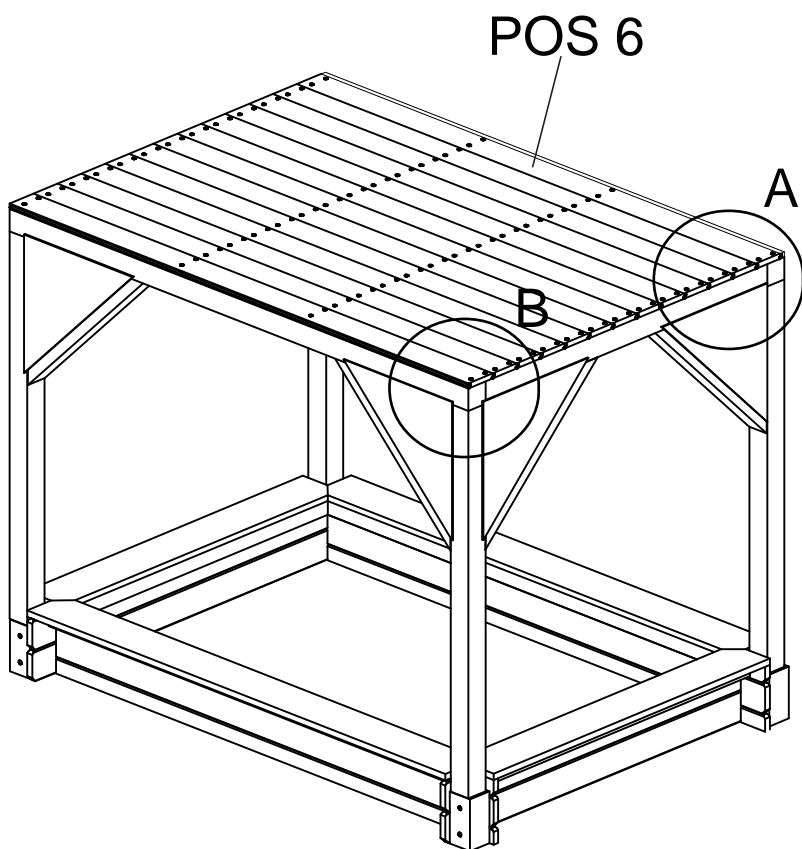
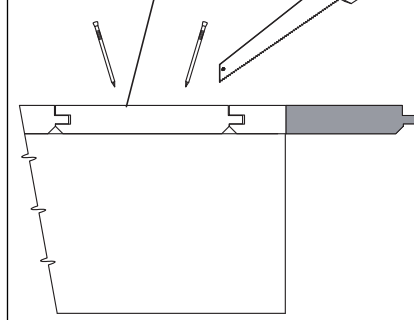



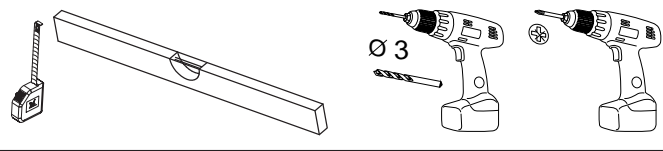

Obvestilo:

Ko prilagodite zadnjo talno desko, zaoblite preostale rezilne robove v polmeru najmanj 3 mm.

6



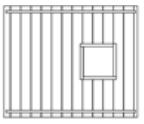

POS

- 7  1000x1207 1X
- 8  1200x1531 1X
- 9  1000x1207 1X
- 10  1200x1511 1X

18X
3,5x35mm



Ø 3

+



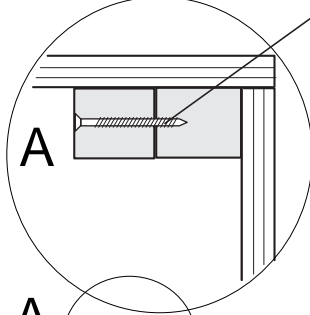
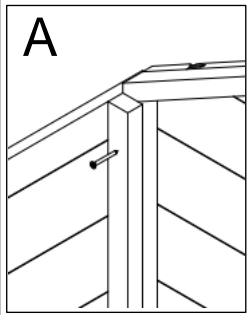
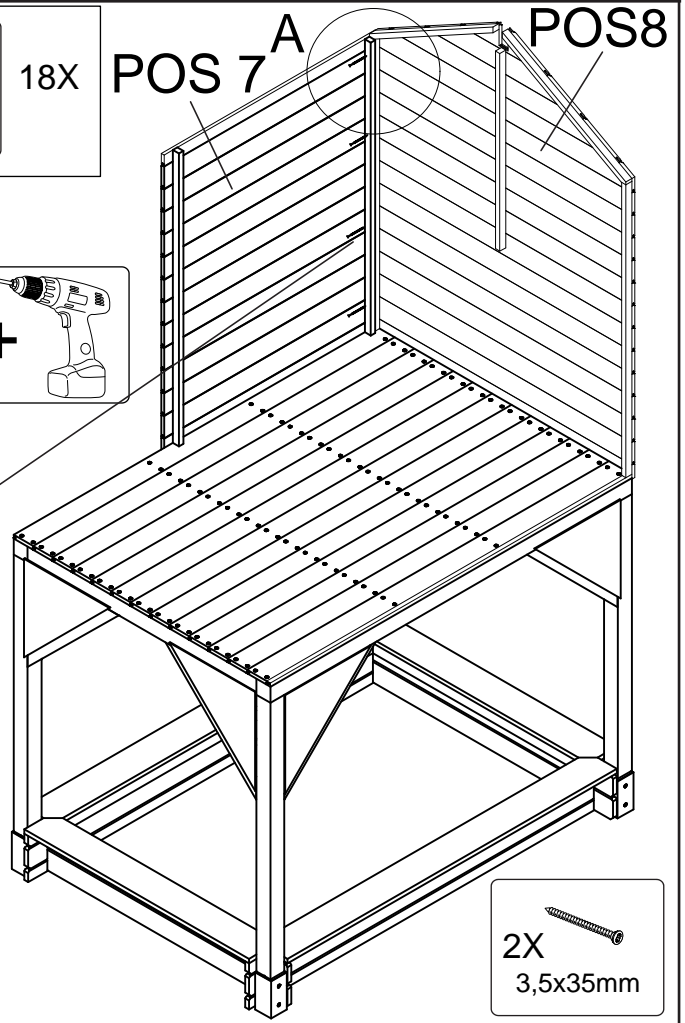

4X
3,5x35mm

2X
3,5x35mm



Ø 3



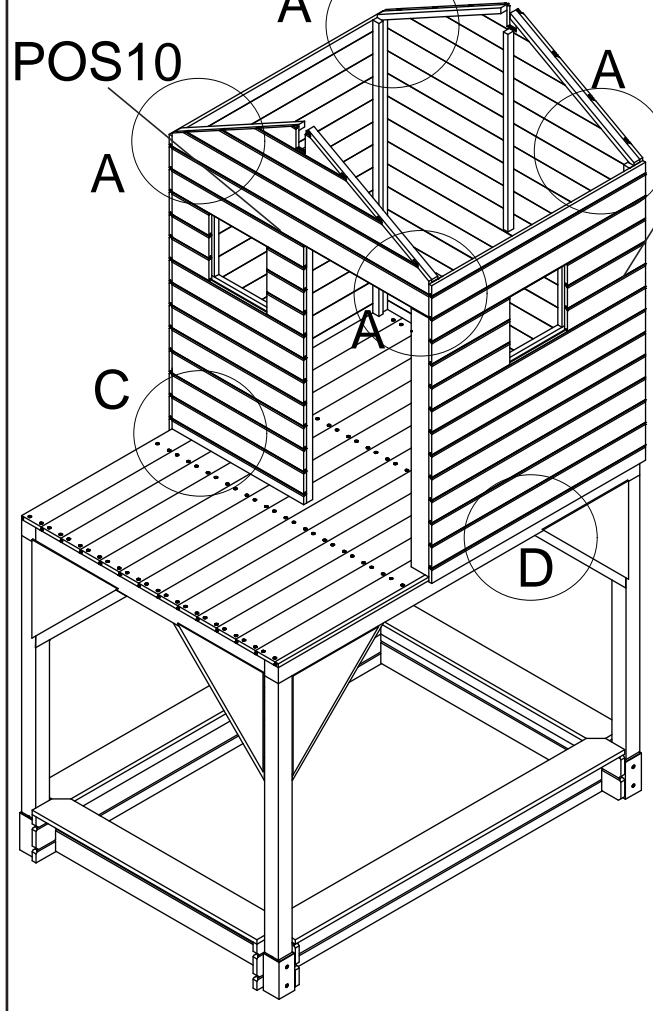

+





POS9

Ø 3

+



3X
3,5x35mm

7

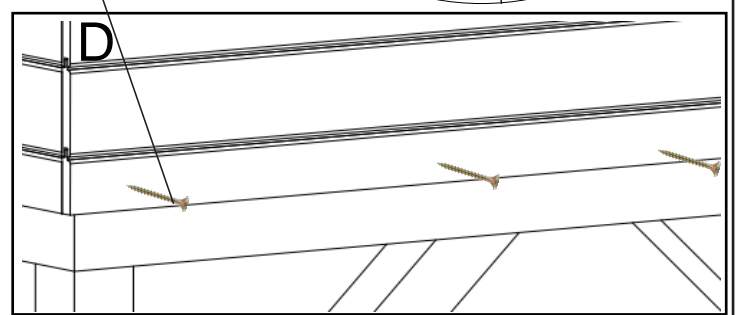
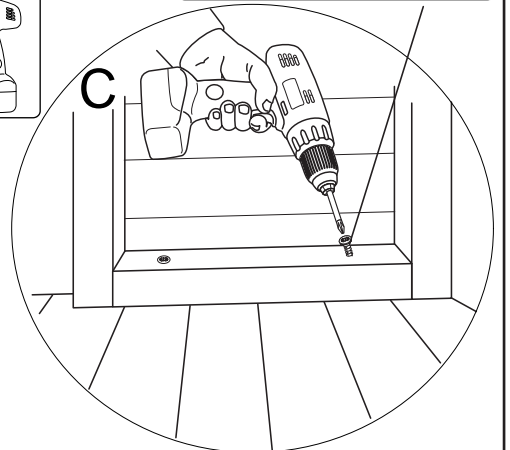

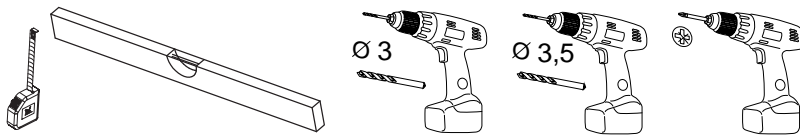
POS

11



43x90x1790 1X

22



12x42x1153 4X



16X

3,5x35mm



4X

4x50mm

POS11

A

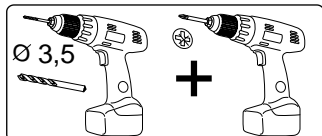
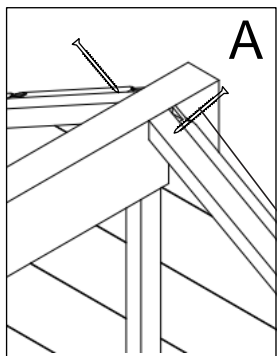
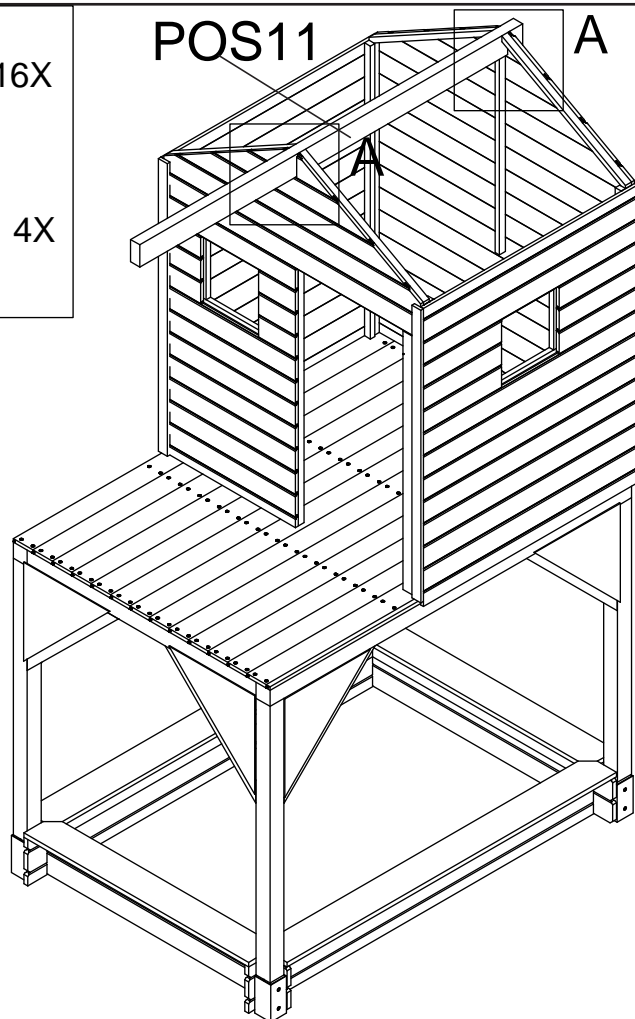

POS22

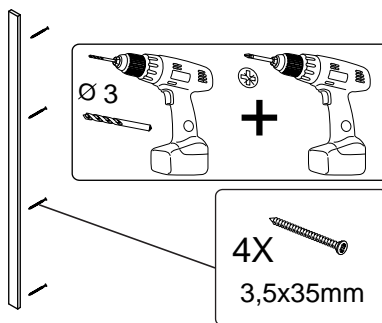
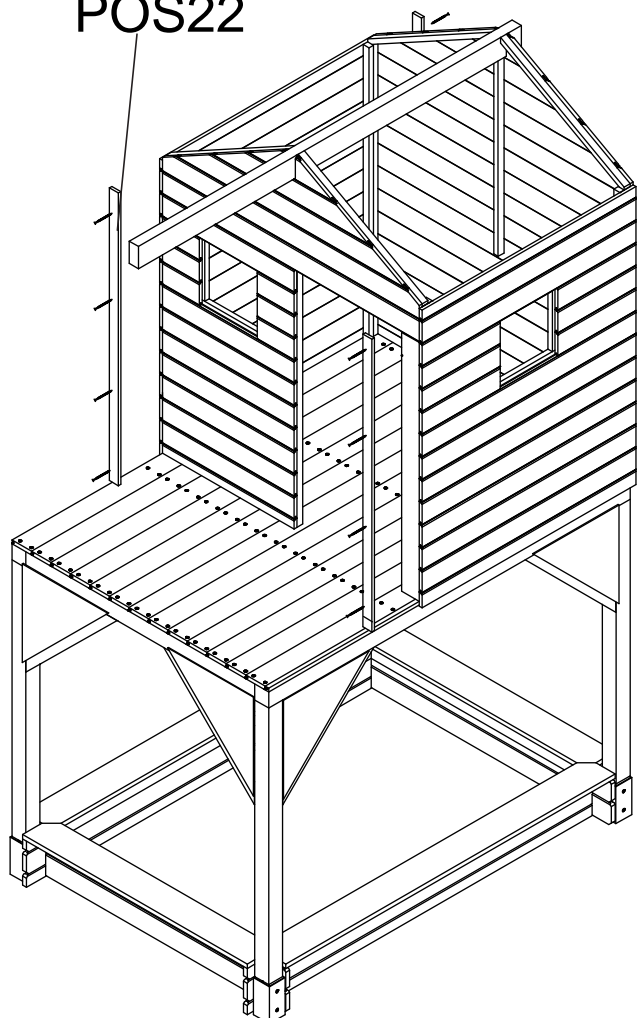

8

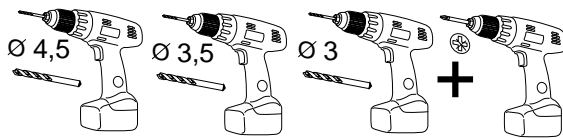
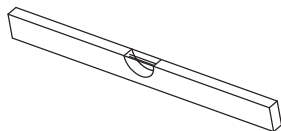

POS

- 12 28x58x1790 2X
- 13 28x65x1310 2X
- 14 28x65x1590 1X
- 46 15x65x720 2X



X6



6X

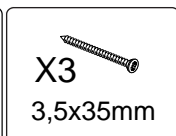
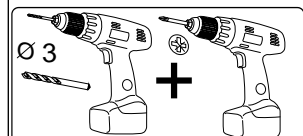

X3

3,5x35mm



X6



6X

POS12

B

A

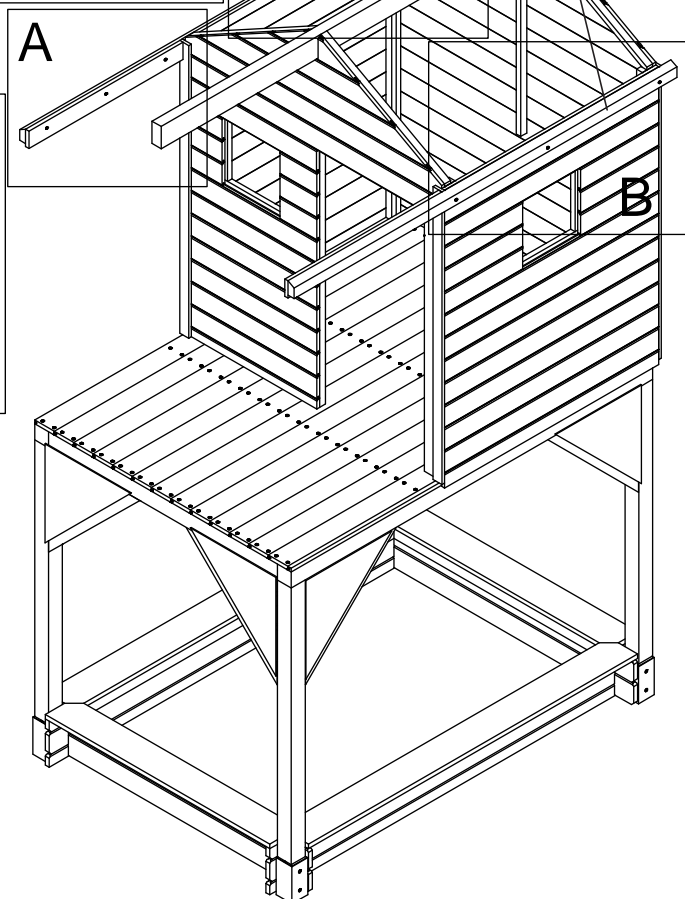

A POS46

POS12

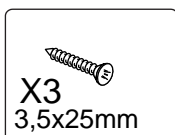
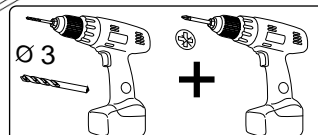
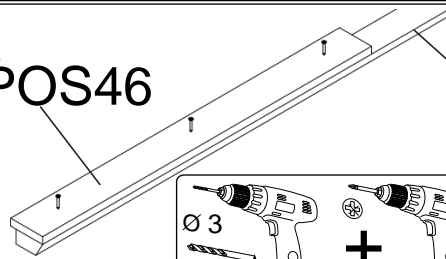

X3

3,5x25mm

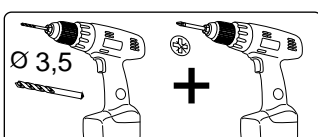

2X

4x50mm

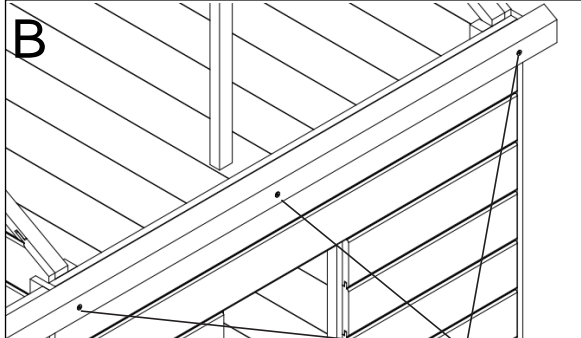
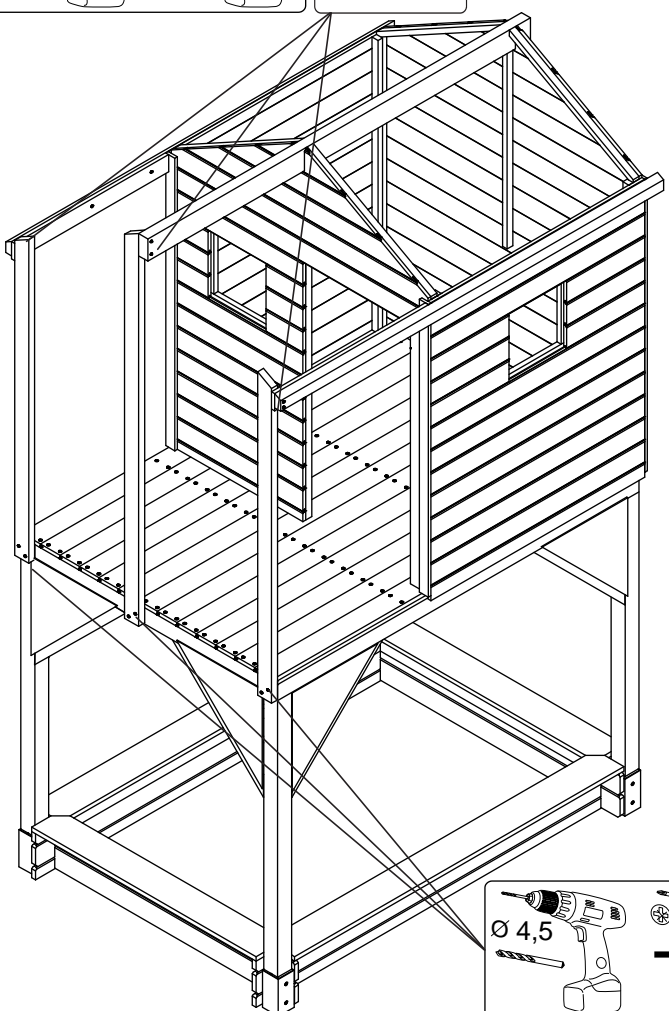

B

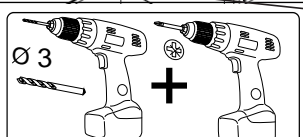

X3

3,5x35mm

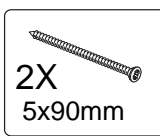
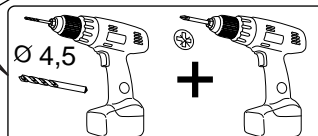

2X

5x90mm

Obvestilo:

Pazite, da se zunanja stojala natančno vodoravno prilegajo kotni oblogi spodaj. Po potrebi jih je treba pobrusiti s pilo.

9

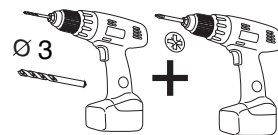
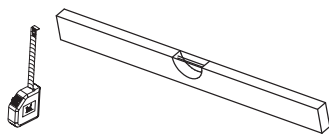

POS

12



478x990 1X

49



19x25x220 1X



X17



X2

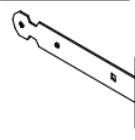

X2



X1

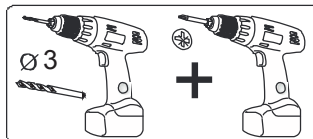

7X

3,5x35mm



M4

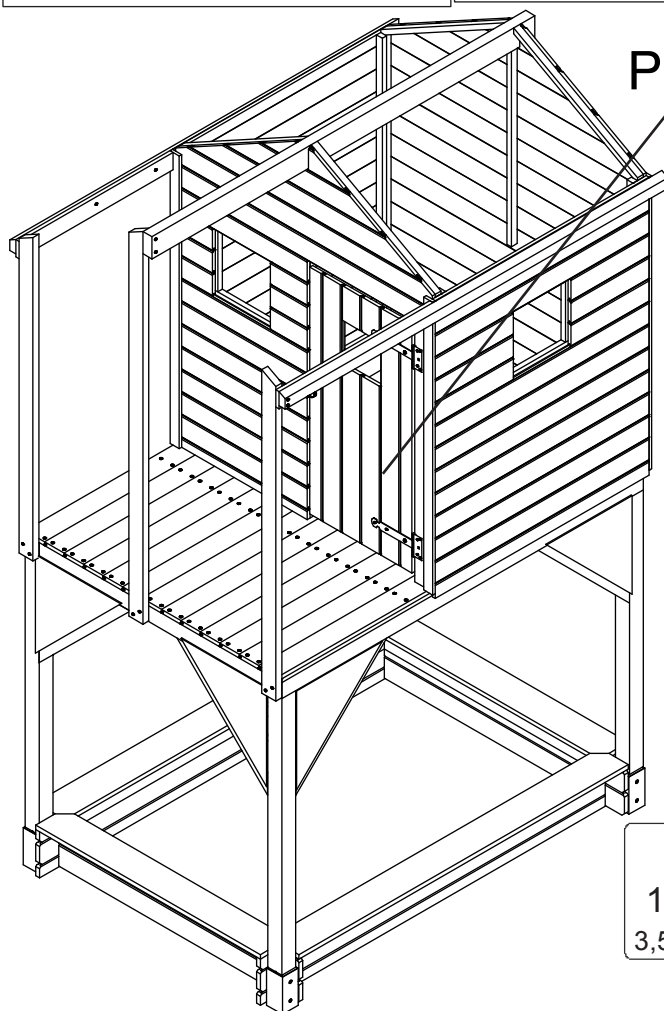

POS12

POS49



1X
3,5x35mm

Trak varovalke (49) mora biti nameščen na sredini odprtine vrat.

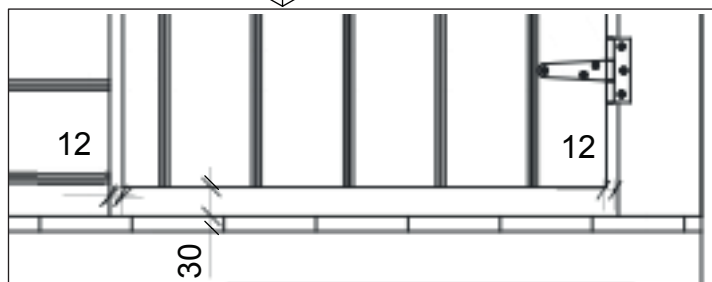

12

12

30

Obvestilo:
Šarnirje pritrdite skozi krilo vrat na nosilno gredo zadnjih vrat.

Obvestilo:

- Usmerite sornike s tečajem sredinsko na špranjo vrat (najmanj 12 mm).
- V izogib nevarnim mestom za ukleščanje se prepričajte, da znaša reža med vrati in talnimi deskami najmanj 30 mm.
- Vrata montirajte tako, da ostane na levi in na desni strani ter zgoraj vsakič 12 mm prostora.
- Preverite, ali je vijak za vratno kljuko dejansko trdno privit in kljuko ni možno obračati.

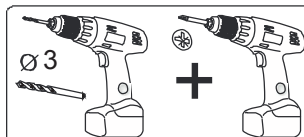

7X
3,5x35mm



M4

10

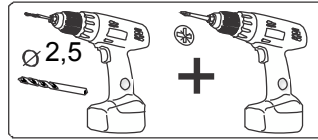
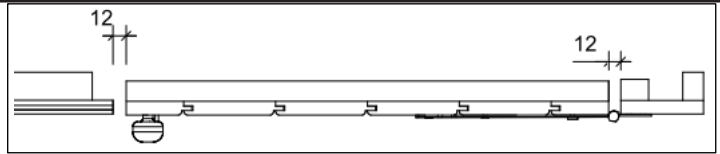
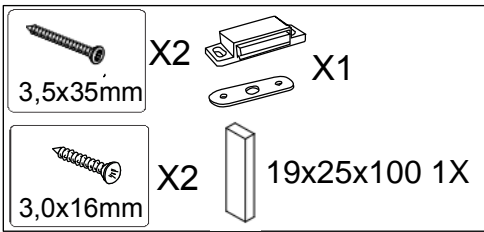
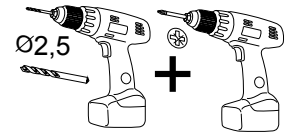
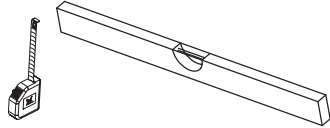

19x25x100 1X

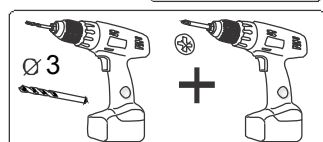
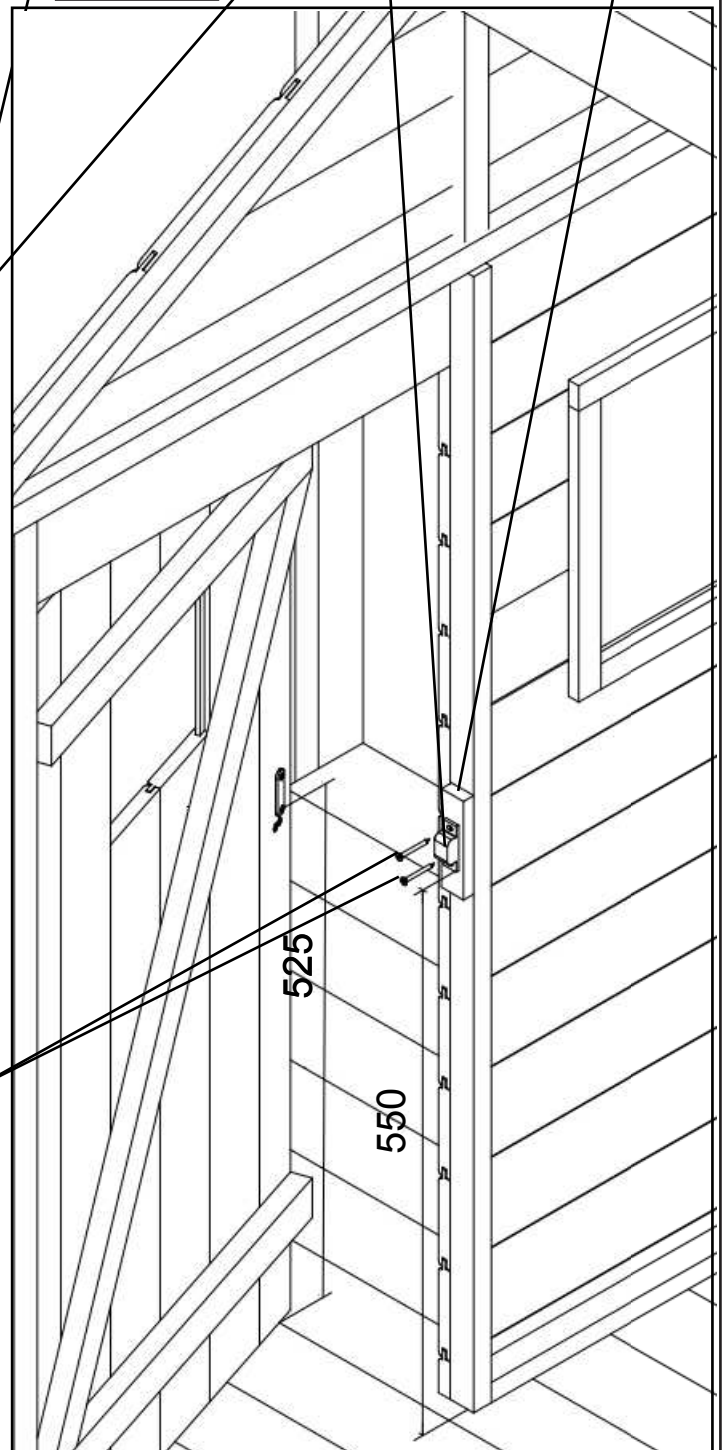
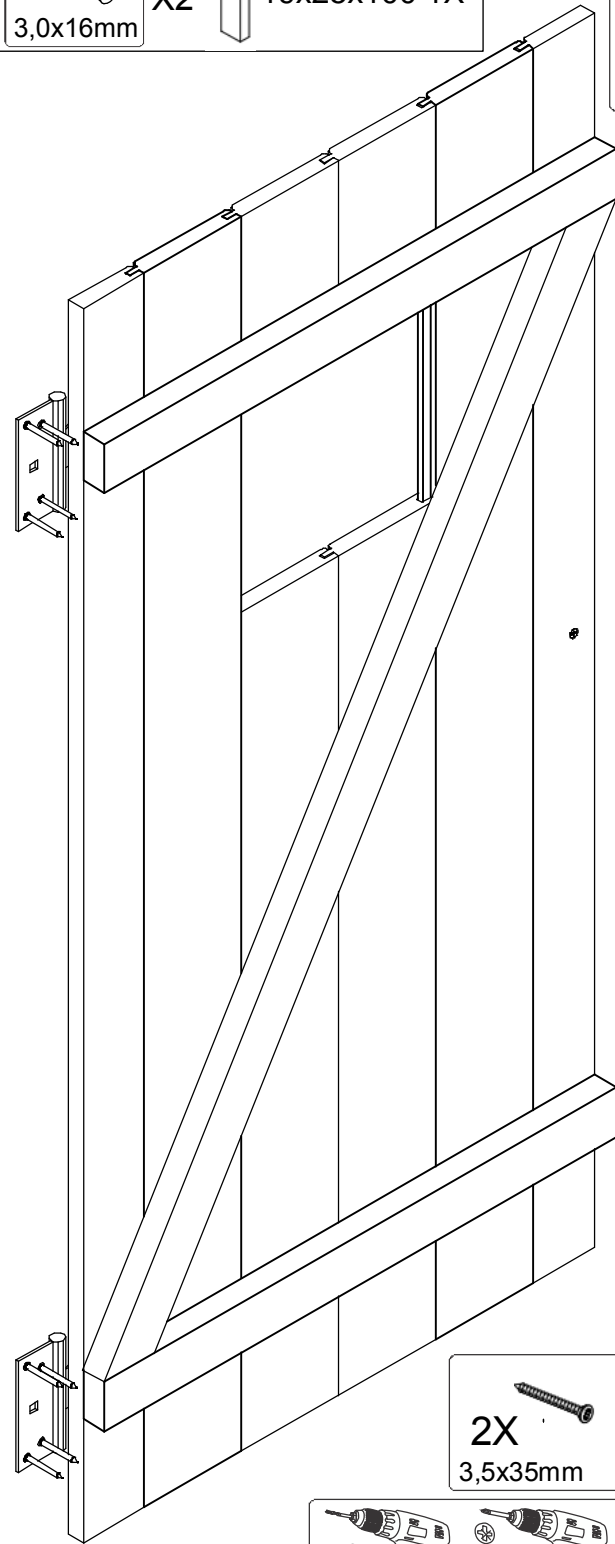
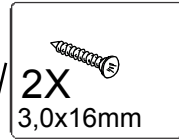

11

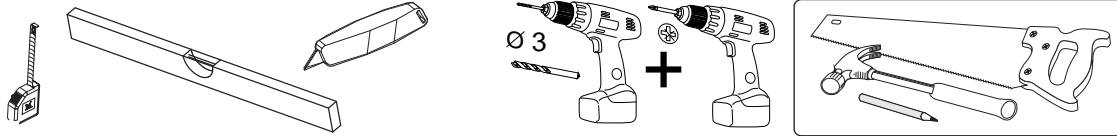

POS

15  15x99x1690 40X

41  12x26x1790 2X

 160X
Ø 2,2x50

 8X
3,5x25mm

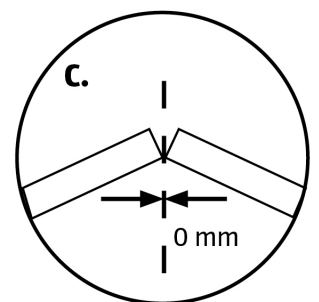
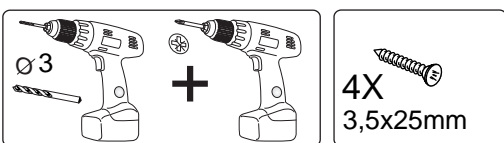
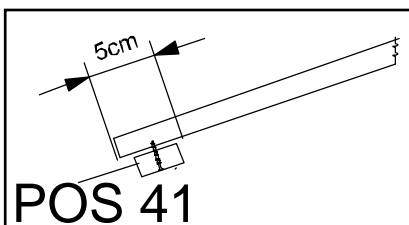
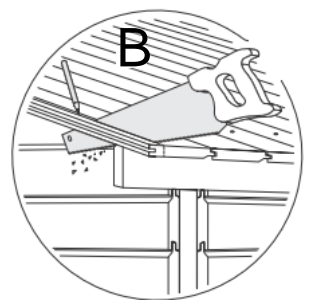
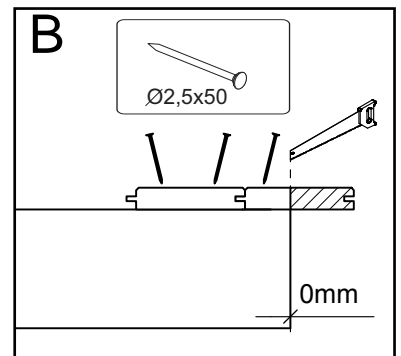
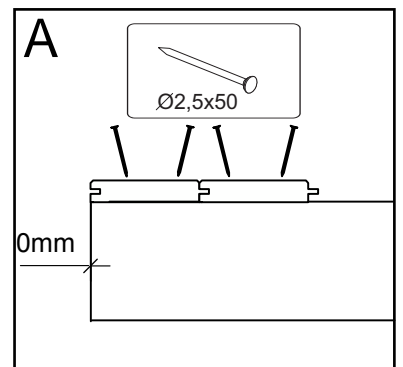
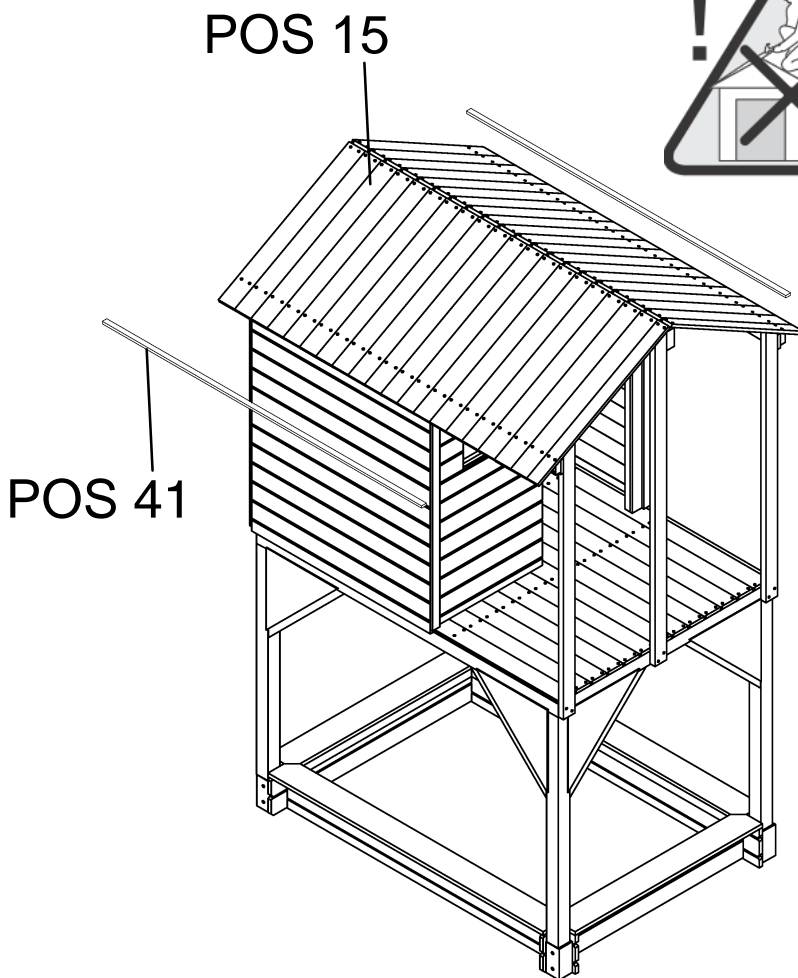
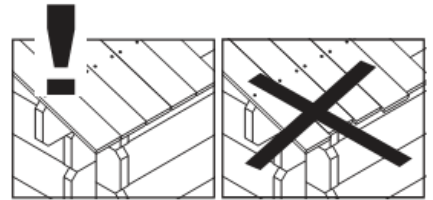
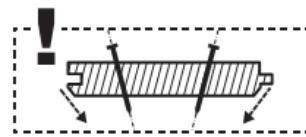

Obvestilo:
Pazite, da so strešne deske na slemenu na sredini montirane tesno poravnano in brez rež.

12

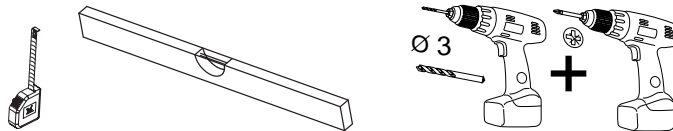

POS

17  15x95x850 4X

18  12x26x860 8X

 24X
3,5x25mm

 16X
3,5x35mm

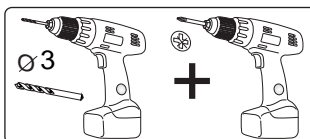

 3,5x25mm

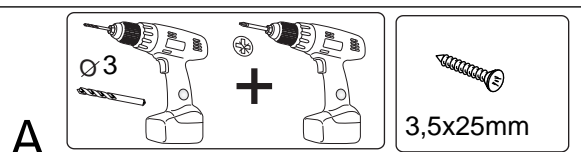

POS 18

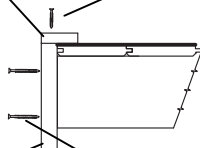

POS 17

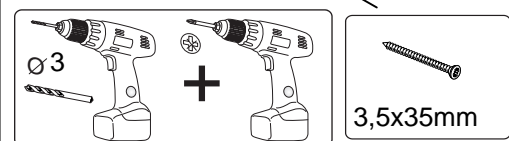

POS 17

Obvestilo:
Strešne letve je mogoče na isti razdalji namestiti na streho.

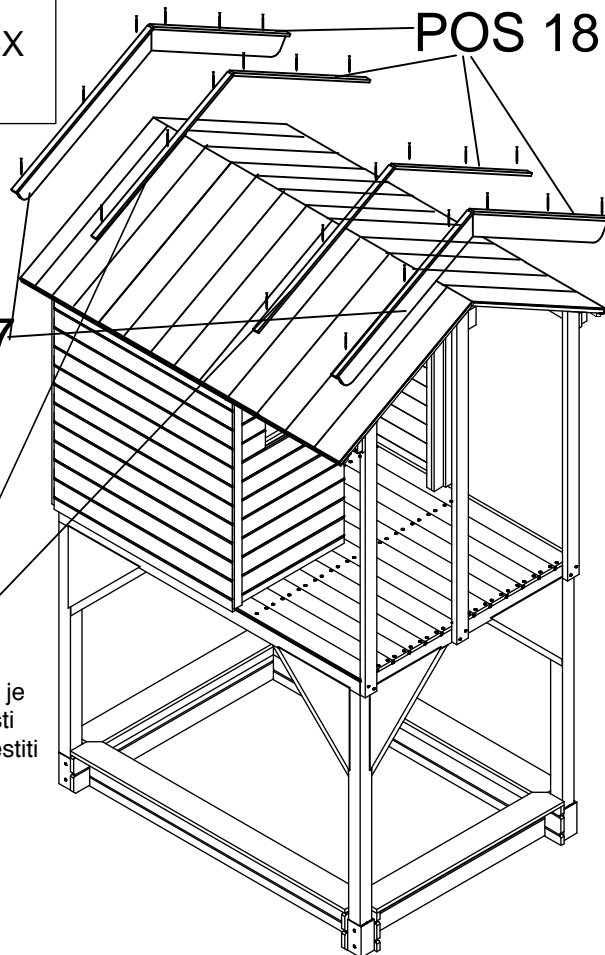

POS 17

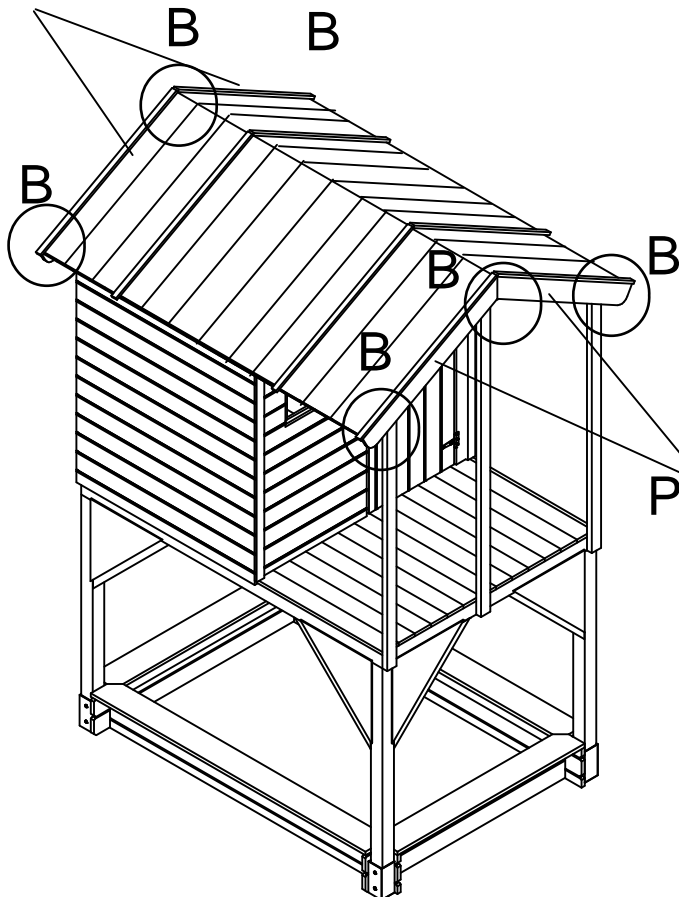

POS 17

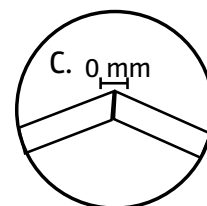

Obvestilo:
Slemenske letve so na zgornji strani poševne. Pri sestavljanju pazite, da pri spoju poševnih prirezov ni prisotnih rež.

13

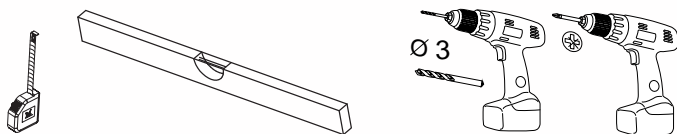

POS

27		27,6x40x510 2X
28		15x95x600 4X
29		35x35x445 1X

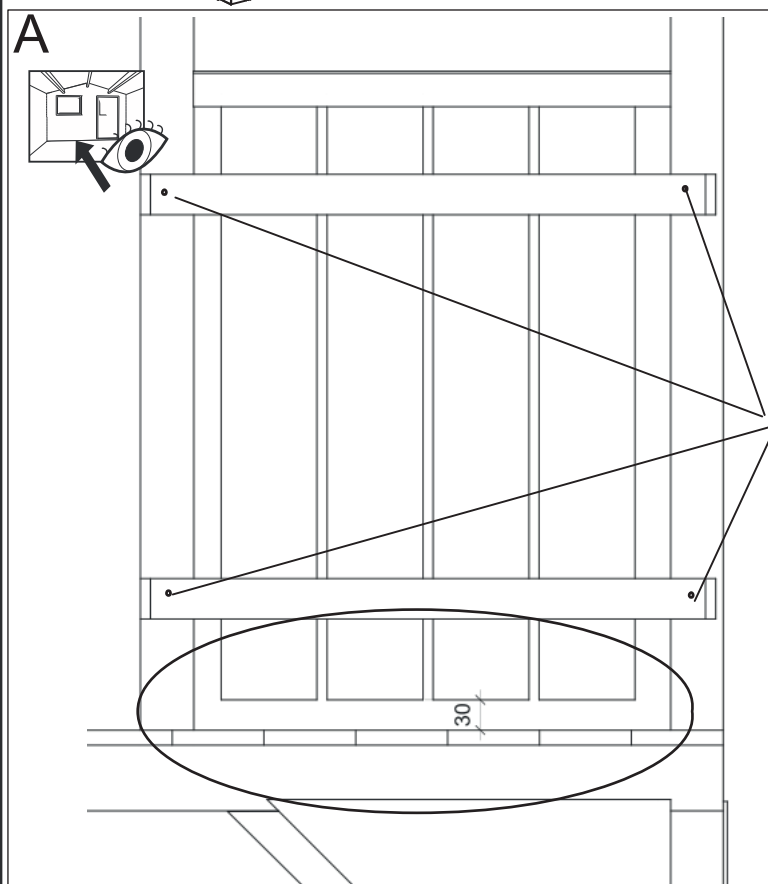
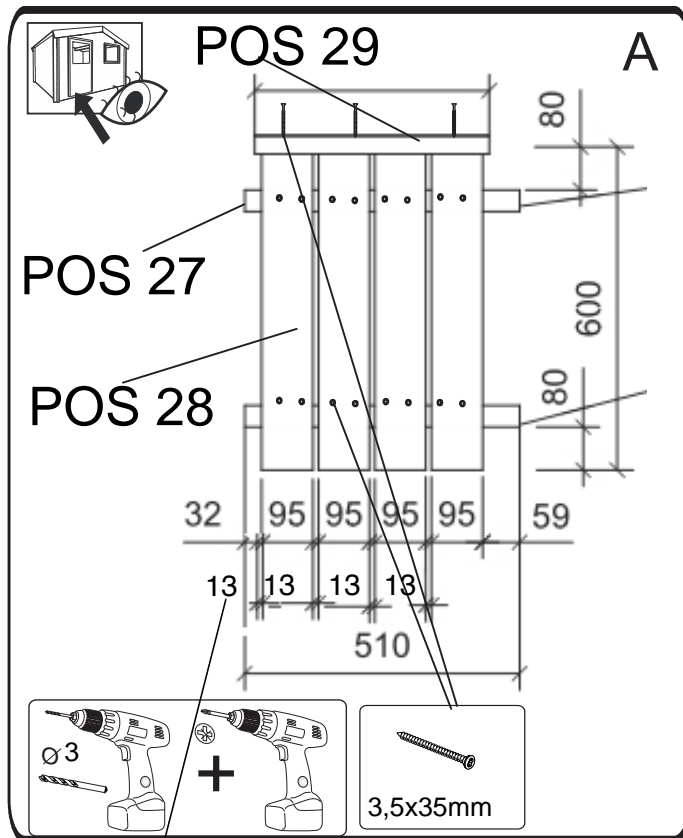
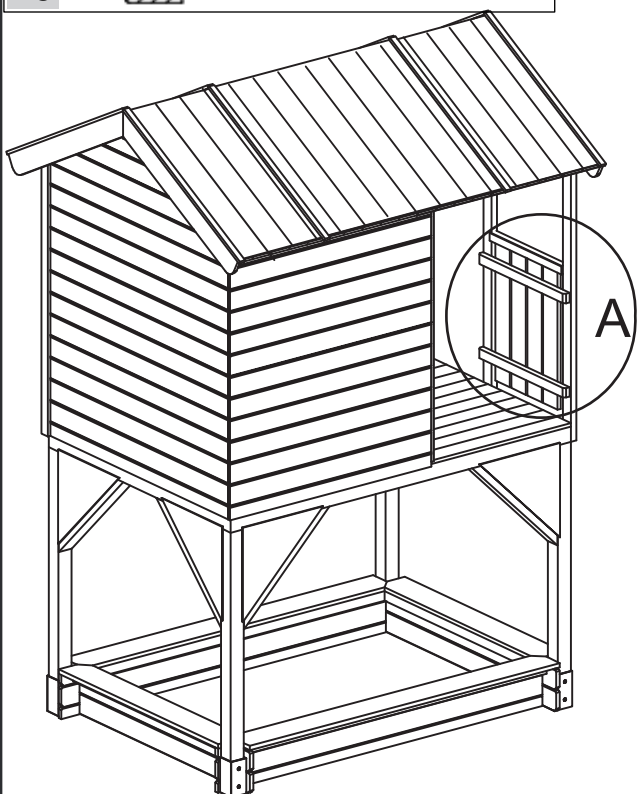
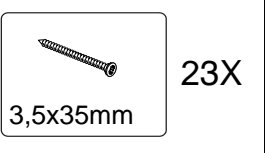

Obvestilo:

V izogib nevarnim mestom za ukleščenje prstov, upoštevajte, da mora odmik med prvo desko ograje in kotnim stebrom znašati najmanj 13 mm.

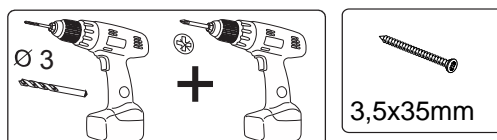

Obvestilo:

V izogib nevarnim mestom za ukleščenje se prepričajte, da znaša reža med vzdolžnimi oporniki ograje in talnimi deskami največ 30 mm.

14

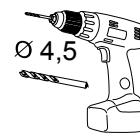
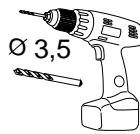
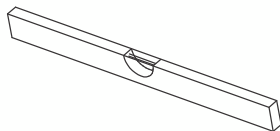

POS

30  34x46x690 2X

31  34x46x600 4X

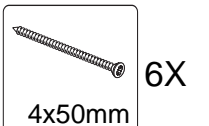
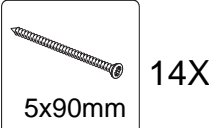

A

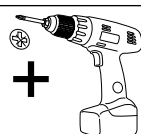
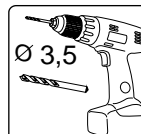

+

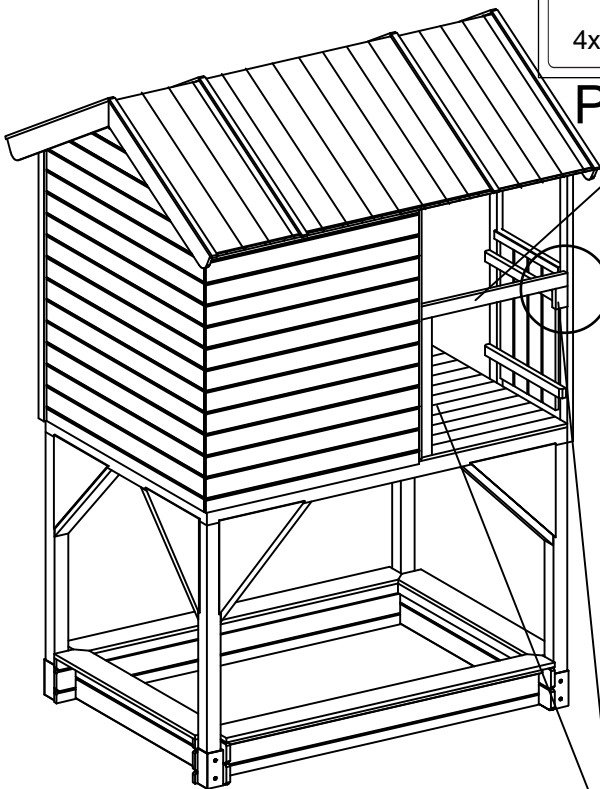
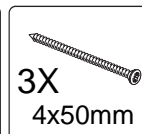

POS 30

A

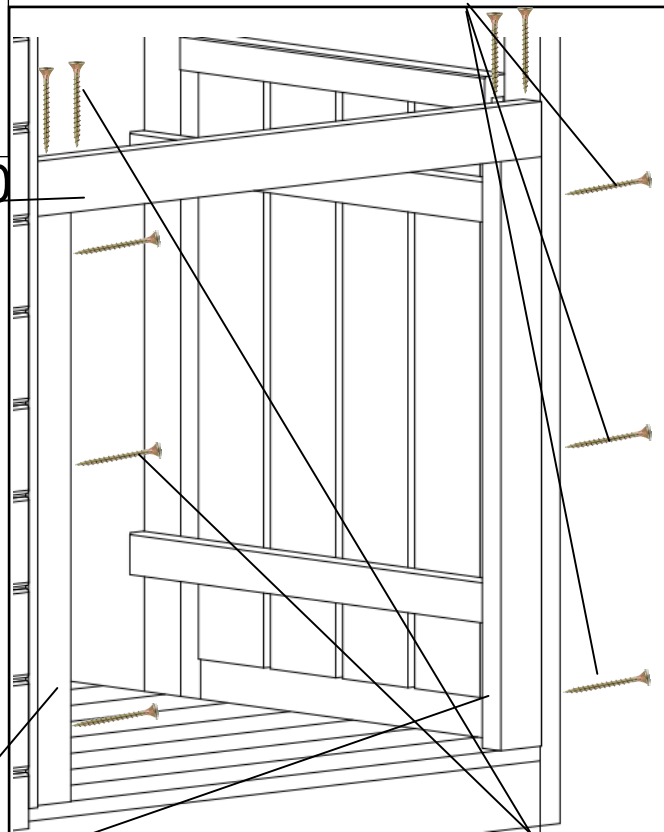

POS 31

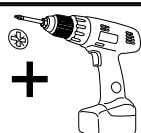
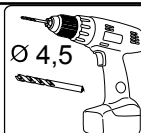

+

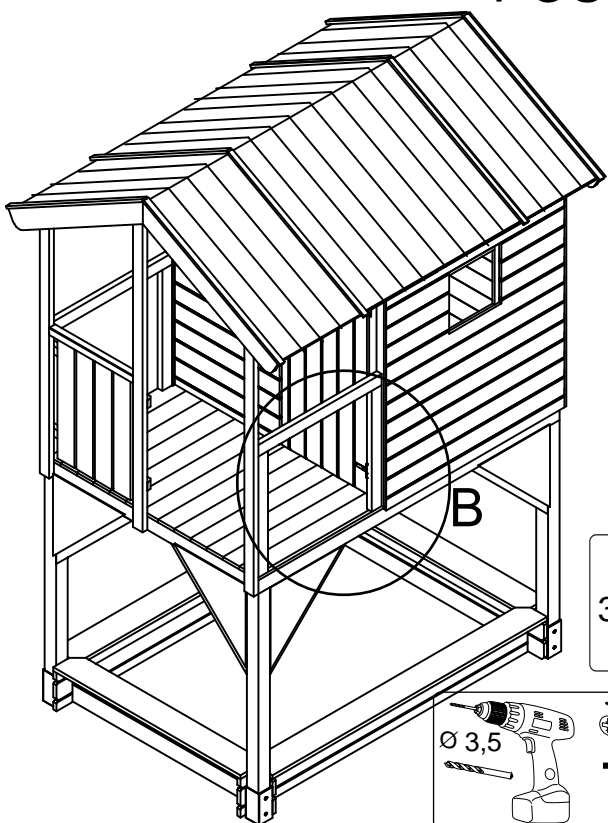
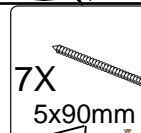

B

POS 30

POS 31

POS 31

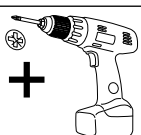
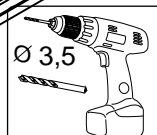
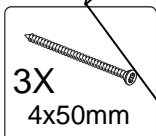

+

15

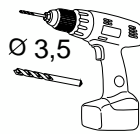
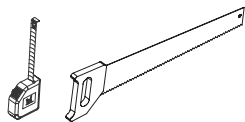

POS

23A  43x90x1441 1X

23B  43x90x1441 1X

24  27,6x120x508 4X

46  15x65x720 1X

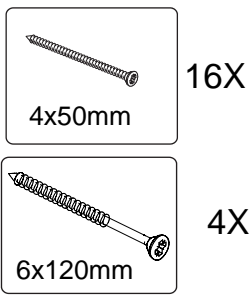

POS 23A POS 46

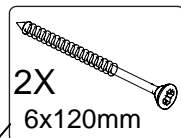
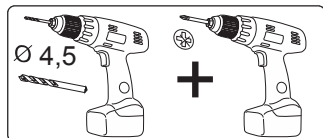
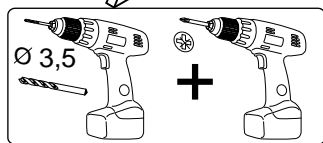
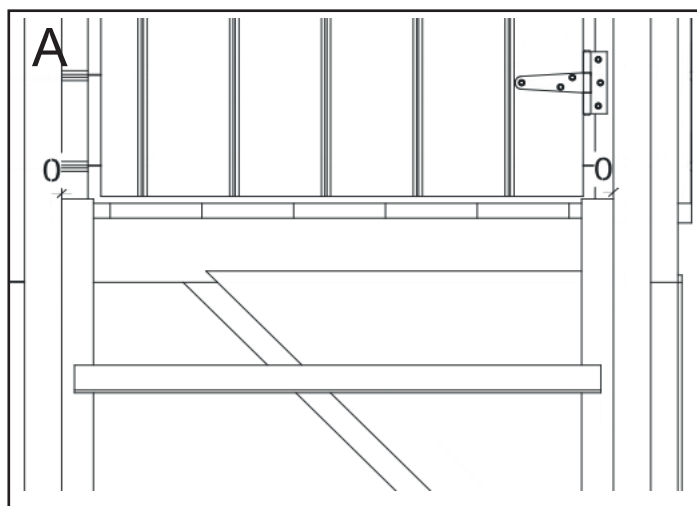
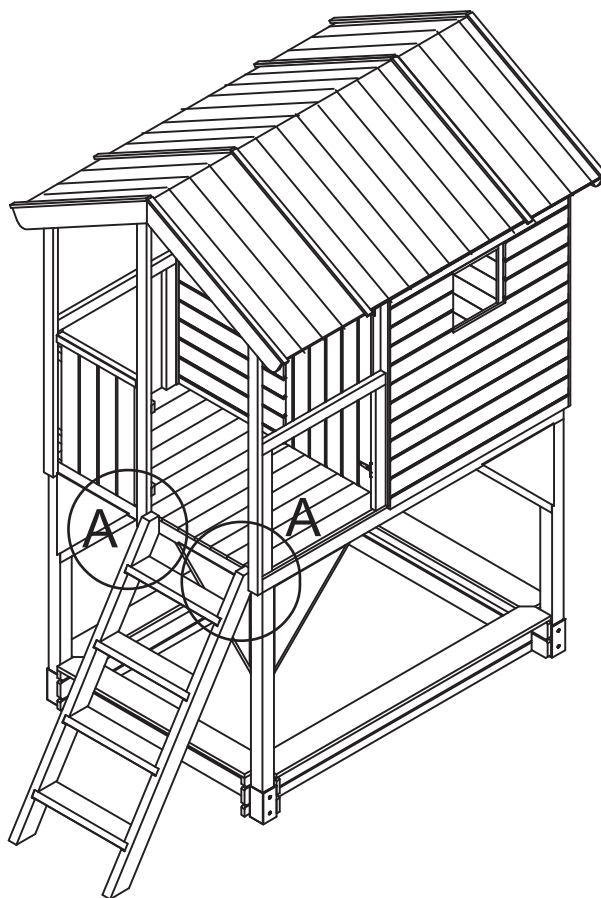
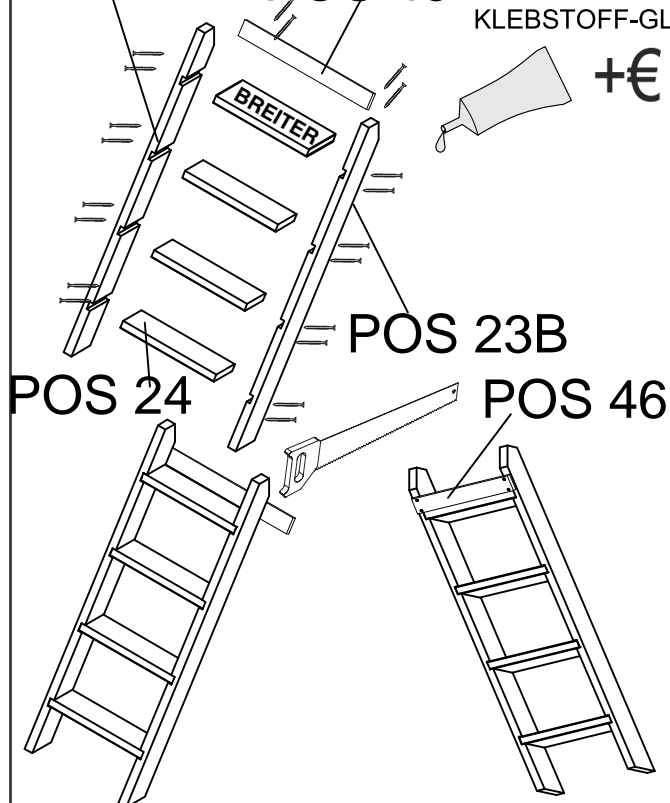

Obvestilo:

Prva stopnica je izvedena nižje od spodnje. To uporabite na najvišjem mestu in poskrbite, da je ta na zadnji strani tesno poravnana s prekrivno desko.

16

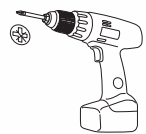
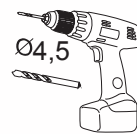
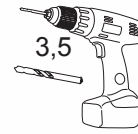
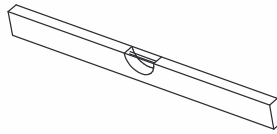

POS

25  34x46x825 2X

26  34x46x1426 2X

 2X
5x90mm

 4X
4x50mm



POMEMBNA NAVODILA ZA VGRADNJO!

Uporabite varno pritrditev priloženi vijaki, matice in spredaj vsi obroči

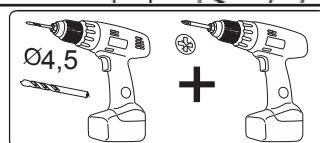
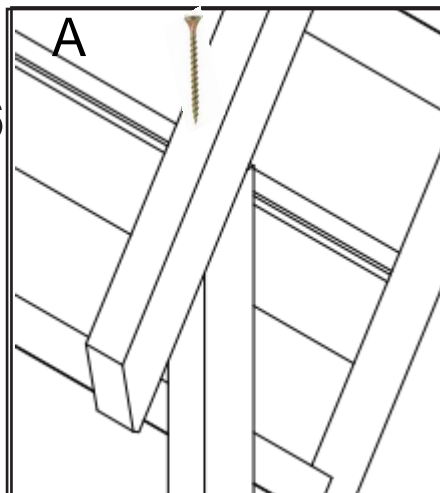
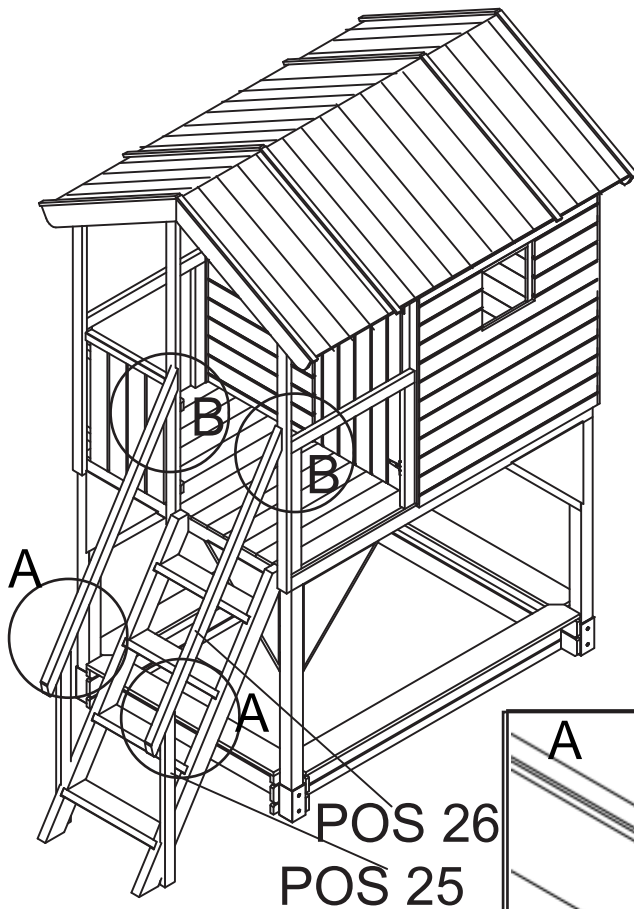

1X
5x90mm

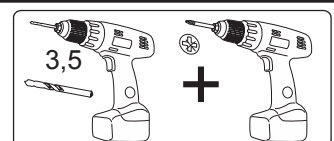
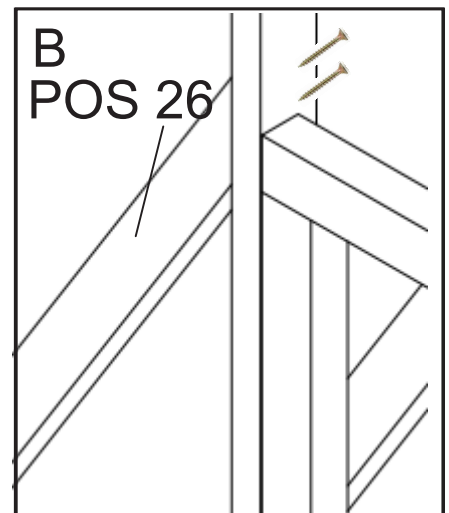

2X
4x50mm

17

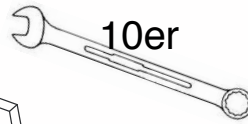
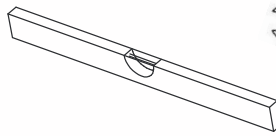

10er

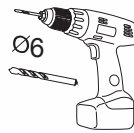

Ø6

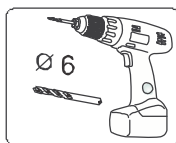
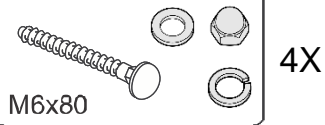

Ø 6

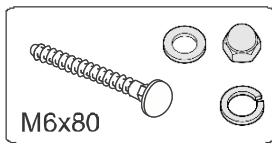

M6x80

A

1.

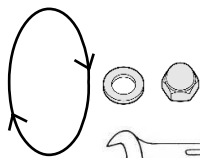
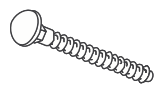

10er



2.

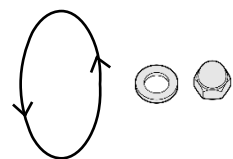

10er

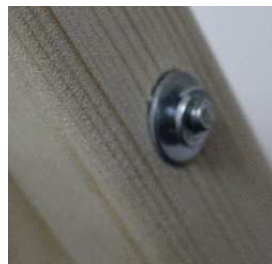

18

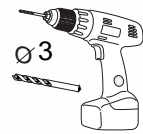
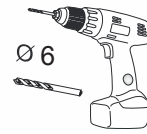
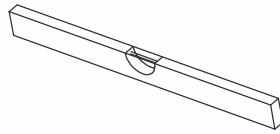

POS

44



18,5x120x680 2X

47

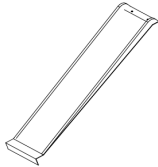

1X



3,5x35mm

8X

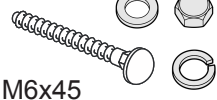

M6x45

2X

POS 44

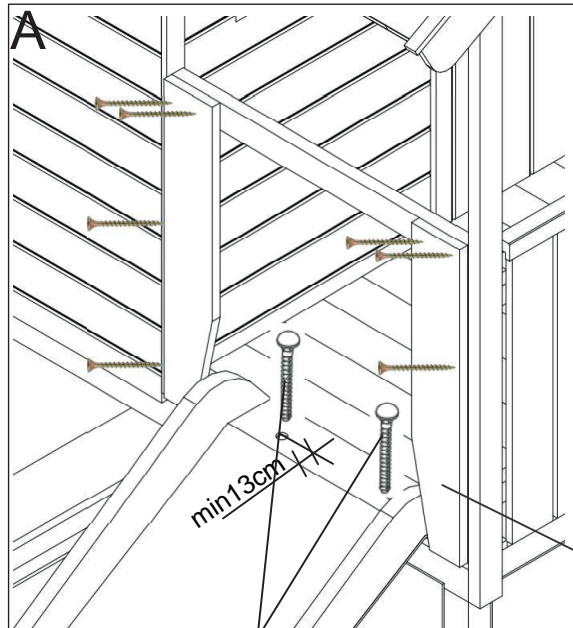

POS 47

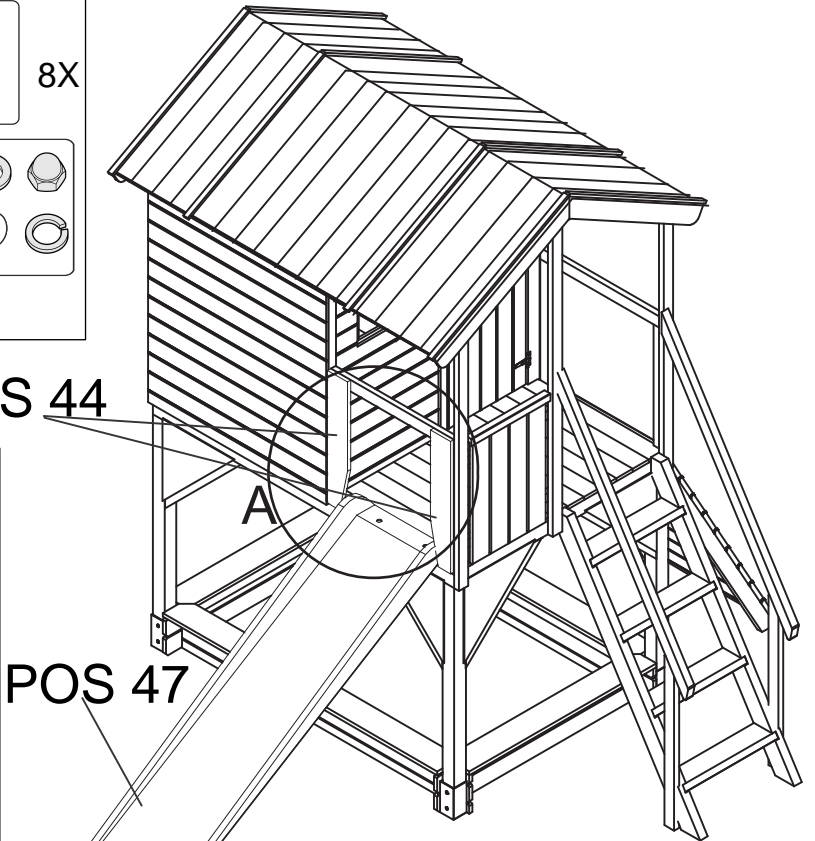

Obvestilo:

tobogan potisnite pribl. 20 mm globoko navznoter na talne deske, tako da se tesno prilega talnim deskam.

8X

3,5x35mm

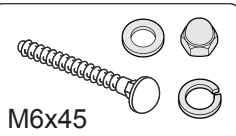
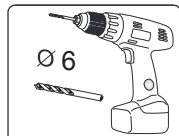

M6x45

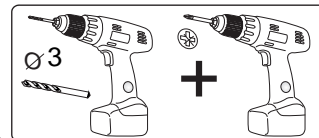

Obvestilo:

V izogib nevarnim mestom za ukleščanje glave in vratu poravnajte tobogan natančno na sredino (30 mm levo in desno) ter levo in desno obenj montirajte bočno zaščito.

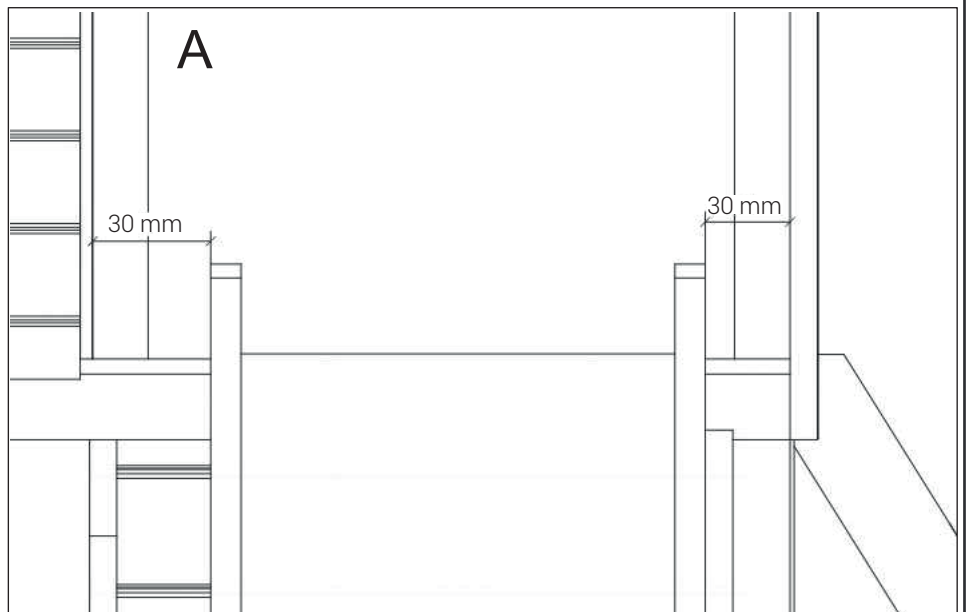

19

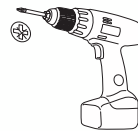
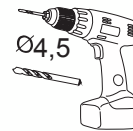
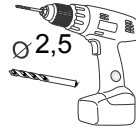
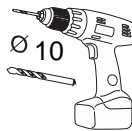
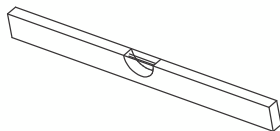

POS

32

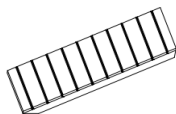

1375X650 1x

48



1X

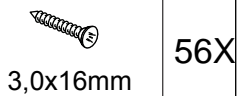

56X

3,0x16mm



4X

5x90mm



5X

M10x30

Obvestilo:

V izogib nevarnim mestom za ukleščanje montirajte plezalno steno tako, da se tesno prilega talnim deskam. Če zaradi materiala iz plezalne stene odpade veja, zaprite odprtino, ker ta predstavlja nevarno mesto za ukleščanje prstov.

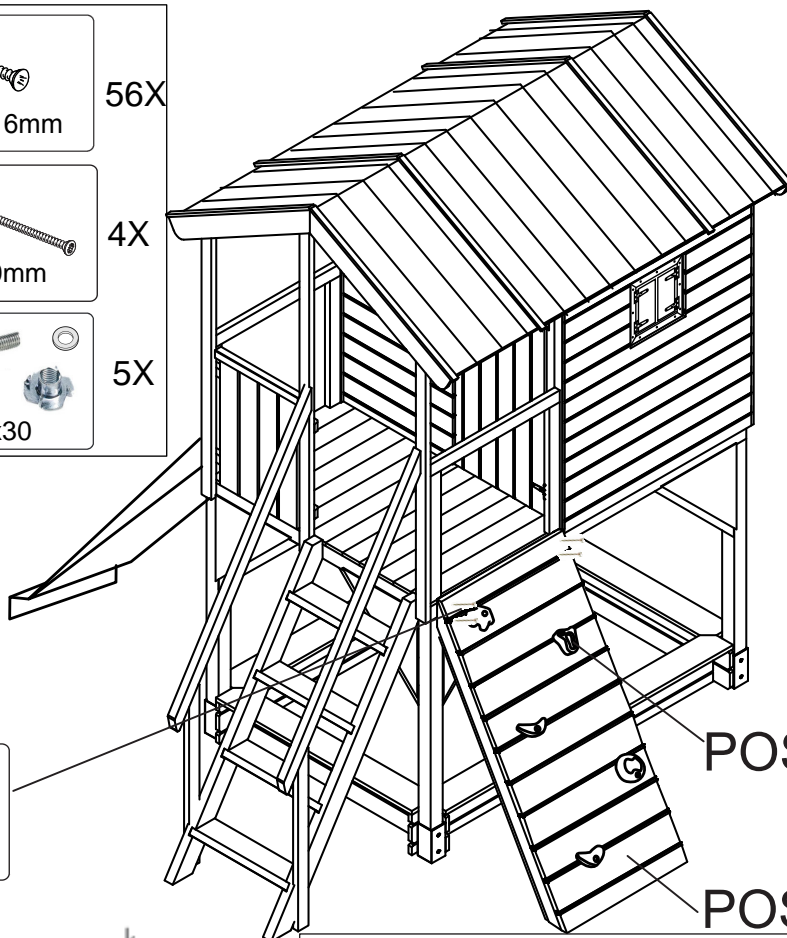

POS 48

POS 32

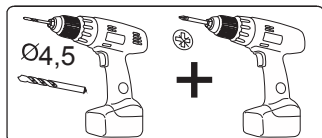

+



2X

5x90mm

320

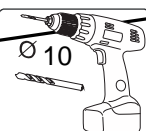
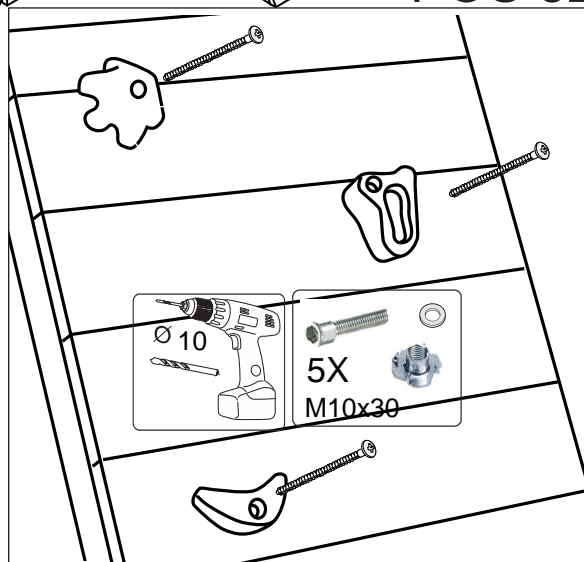
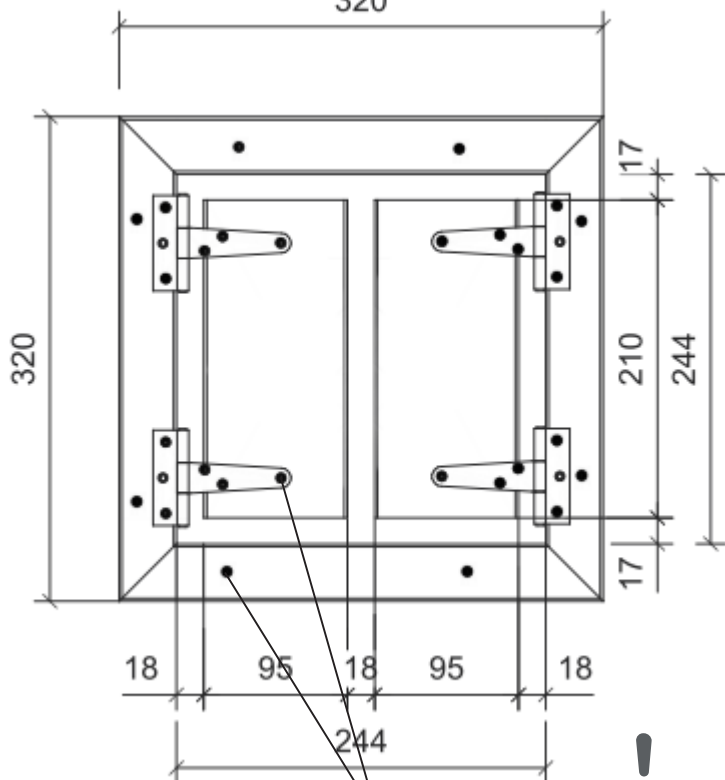

5X

M10x30

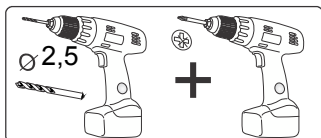

+

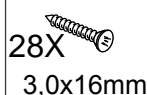

28X

3,0x16mm





GARANCIJSKI LIST



IGRALNA HIŠICA S PESKOVNIKOM

Predlagamo, da se pred vračilom izdelka obrnete na našo **POPRODAJNO PODPORO**, kjer bomo poskušali v najkrajšem možnem času najti rešitev tudi pri morebitnih vprašanjih v zvezi z uporabo izdelka.

03/2022

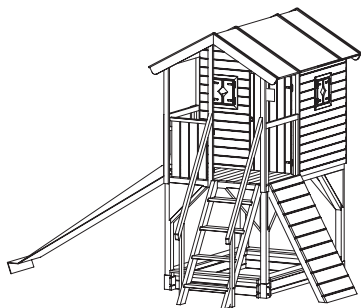

IZDELEK:

HOFER 2022

POPRODAJNA PODPORA

 **+381 1 899 5280**

 **office.slo@gartenpro.at**

ŠTEVILKA IZDELKA

309412/720023

NASLOV SERVISA

Boris Kremzar s.p.
CKS 18
11270 Litija
SLOVENIA

Opis napake:

Vaši podatki:

Ime kupca: _____

Naslov: _____

E-pošta: _____  _____

Garancijski pogoji

Cenjeni kupec,

za vsak pri nas kupljeni izdelek vam zagotavljamo najobsežnejšo garancijo kakovosti. Ker smo prepričani v kakovost naših izdelkov, vam **HOFER garancija** zagotavlja še širši nabor ugodnosti, kot je to določeno z zakonskimi določili:

Veljavnost garancije:	3 leta od prevzema izdelka
Nudimo vam:	Brezplačno popravilo oz. zamenjavo izdelka ali vračilo denarja Brez stroškov prevoza
Telefonska pomoč:	+3811 899 5280 Po običajni tarifi fiksnega omrežja vašega ponudnika telefonije.
Dosegljivost:	pon.–pet. 08.00–17.00

Prosimo, upoštevajte, da ima **HOFER trgovina d.o.o.** možnost o vsakem posameznem garancijskem zahtevku odločiti po lastni presoji.

Da lahko uveljavljate garancijo:

- morate imeti pripravljen izpolnjen garancijski list in račun
- pokličite na telefonsko številko **POPRAJNE PODPORE**

Garancija ne velja v naslednjih primerih:

- **za škodo, ki je nastala kot posledica vremenskih vplivov** (npr. udara strele, vode, ognja, zmrzali ipd.), **nesreče, prevoza, pri izpraznjenih baterijah** ali **nepravilni uporabi**
- **za poškodbe ali spremembe, ki jih povzroči kupec/tretja oseba**
- **zaradi nespoštovanja varnostnih opozoril, navodil za vzdrževanje in zaradi napak pri uporabi**
- **zaradi vodnega kamna in škode, ki jo je le-ta povzročil, izgube podatkov, škodljive programske opreme in poškodbe zaradi vročine**
- **za normalno obrabo obrabljivih delov (npr. zmogljivost akumulatorja)**

Garancija velja za proizvode izročene na območju Republike Slovenije. Proizvajalec jamči za kakovost oziroma brezhibno delovanje izdelka v garancijskem roku, ki začne teči z izročitvijo blaga. Če popravila ni mogoče izvesti v 45 dnevnem roku, bo izdelek popravljen, zamenjan ali pa bo ob soglasju kupca povrnjena kupnina. Garancijska doba se podaljša za čas popravila. Po izteku veljavnosti garancije lahko izdelek na **NASLOV SERVISA** še vedno posredujete v popravilo. Če vam popravila ali izdelave predračuna ne moremo nuditi brezplačno, boste o tem vnaprej obveščeni.

Ta garancija ne vpliva na druge zakonske garancijske obveznosti prodajalca in ne izključuje pravic potrošnika, ki izhajajo iz odgovornosti prodajalca za napake na izdelku. Veljavnost garancije se lahko podaljša le, če to predvideva zakon. V državah, v katerih so (obvezna) garancija in/ali skladiščenje rezervnih delov in/ali odškodnina za škodo določeni z zakonom, veljajo zakonsko predpisane minimalne zahteve. Servisna služba in prodajalec pri sprejemu izdelka v popravilo ne prevzemata odgovornosti za izgubo kakršnihkoli podatkov ali nastavitev, ki jih je kupec shranil na izdelku.

Oznaka proizvajalca/uvoznika: Gartenpro GmbH Hauptstraße 9 4707 Schlüßlberg, AUSTRIA	Podjetje in sedež prodajalca: HOFER trgovina d.o.o. Kranjska cesta 1 1225 Lukovica, SLOVENIJA
Podpis prodajalca:	



Distributer:

CARSTENSEN IMPORT-EXPORT
HANDELSGESELLSCHAFT MBH
WERNER-VON-SIEMENS-STR. 3-7
D-25479 ELLERAU
GERMANY

POPRODAJNA PODPORA

309412/726775



SI +3811 899 5280



www.carstensen.de

IZDELEK:
HOFER 2023

03/2023

3

**LETA
GARANCIJE**