

FILTRA PRO INOX & DESIGN

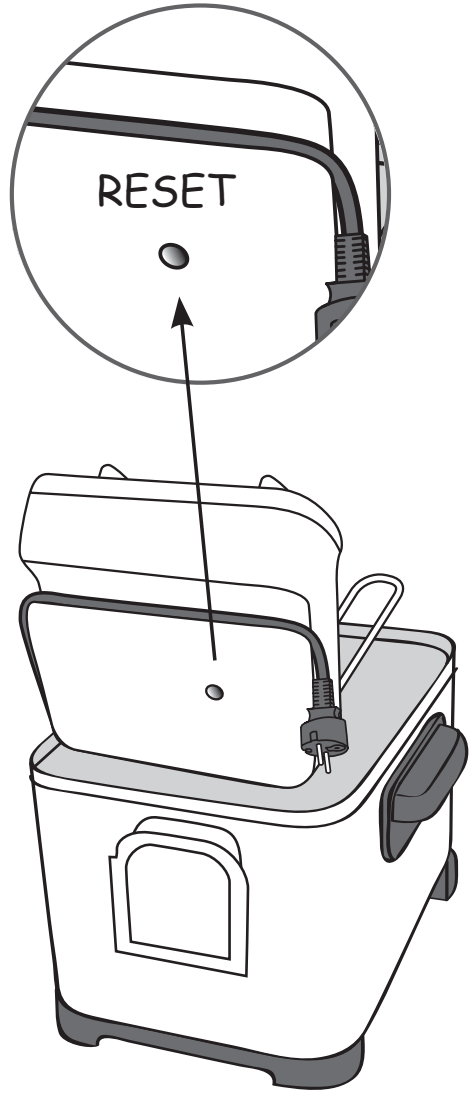

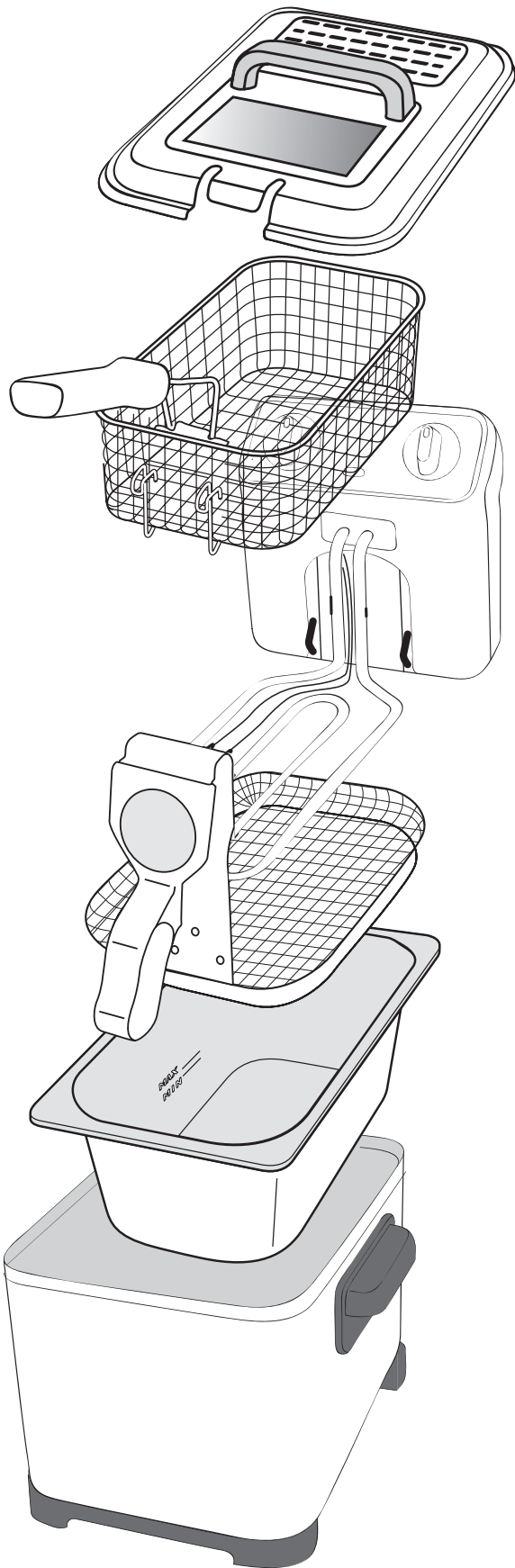



1

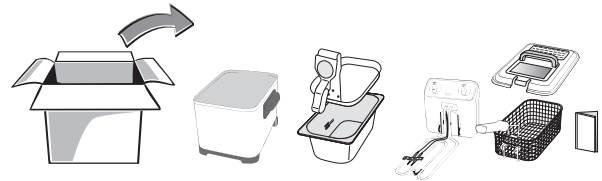
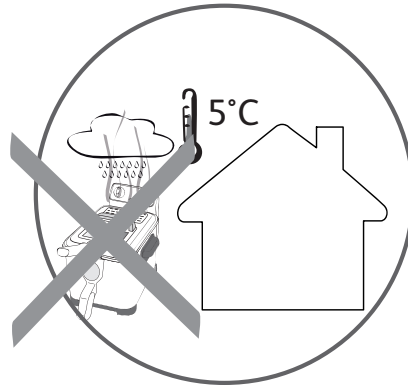
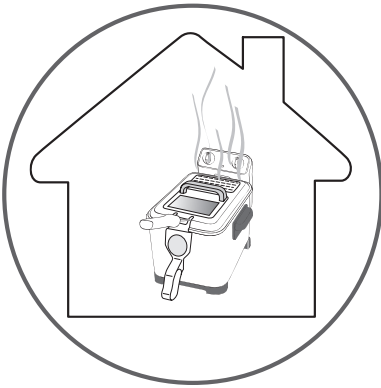

2

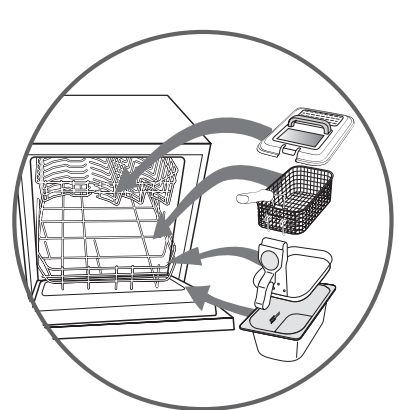
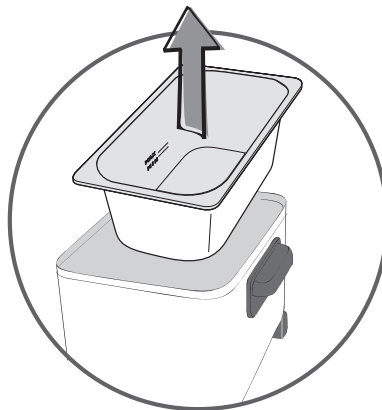
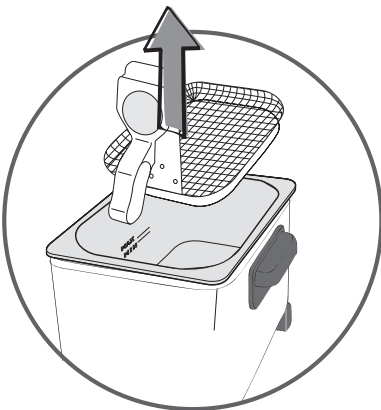
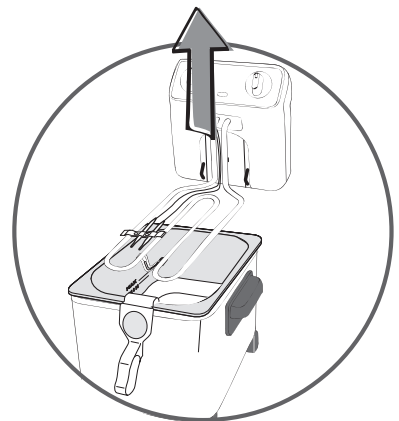
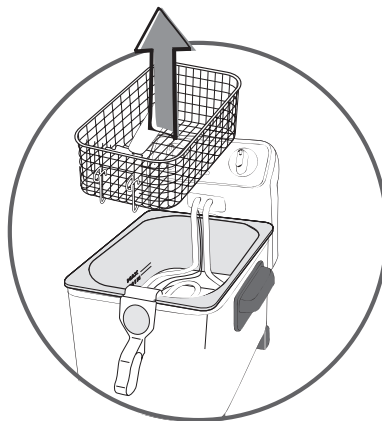
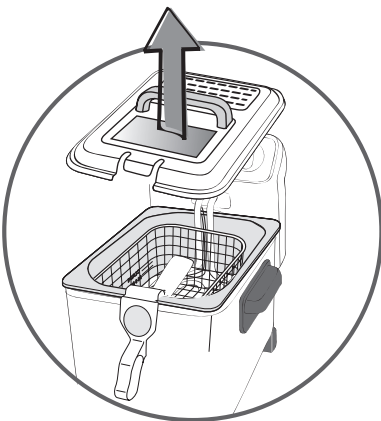

3

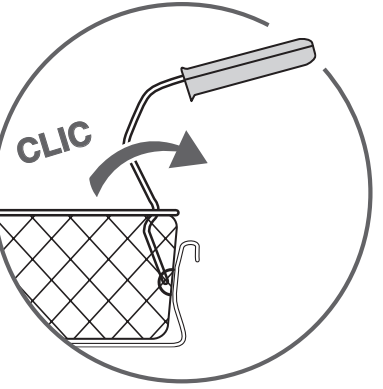
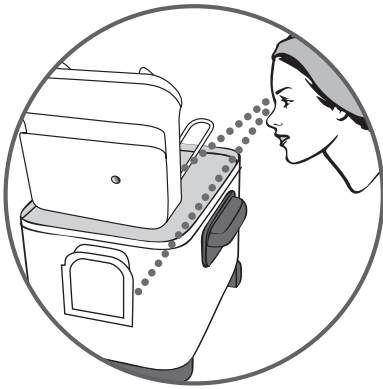
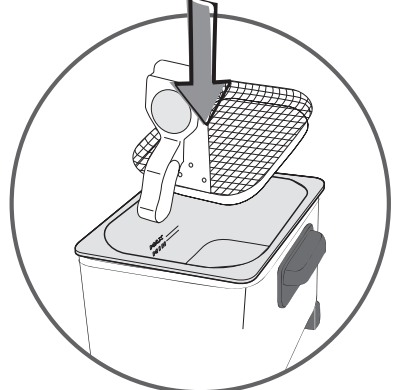
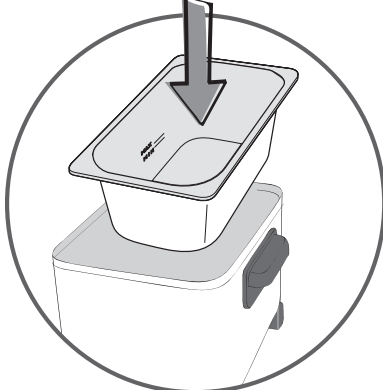
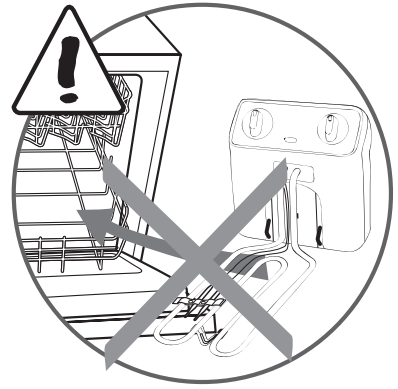
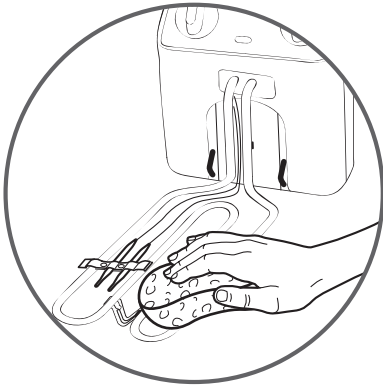



| | | |
|-------|------|------|
| Model | 3L | 4L |
| Min. | 2,2L | 3,3L |
| Max. | 3L | 4L |

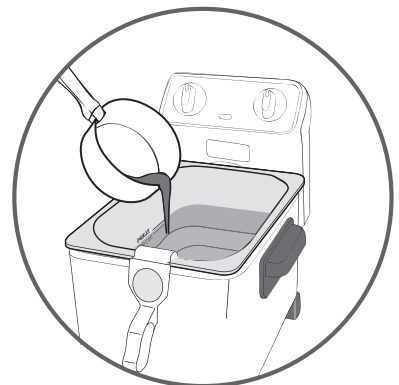
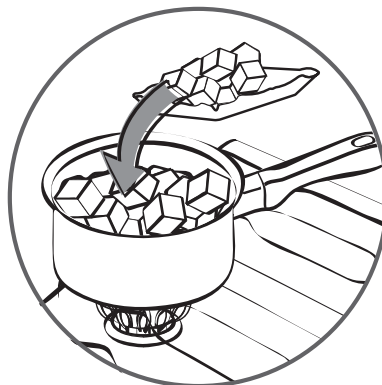
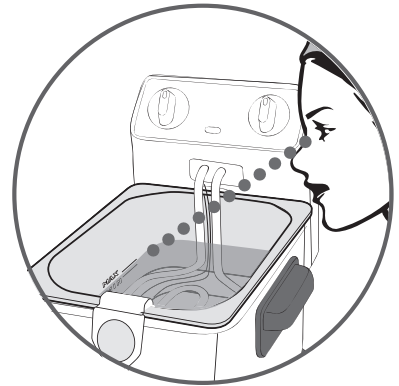

| | | |
|-------|-------|-------|
| Model | 3L | 4L |
| Min. | 1925g | 2890g |
| Max. | 2625g | 3500g |

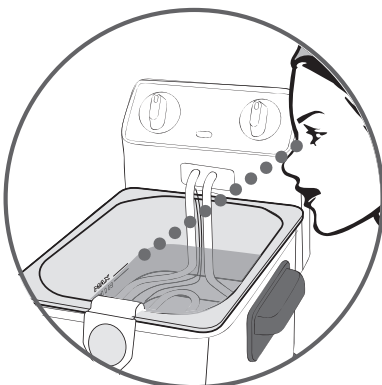

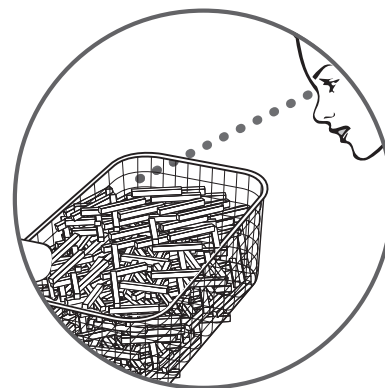
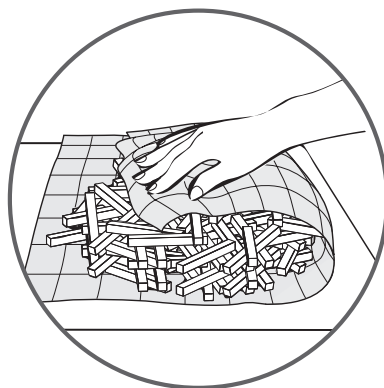
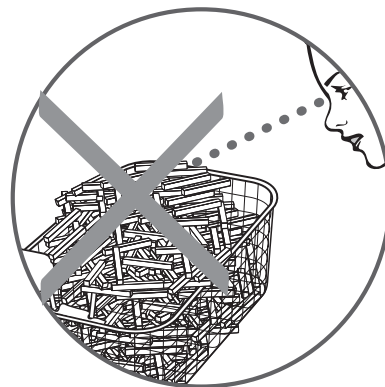
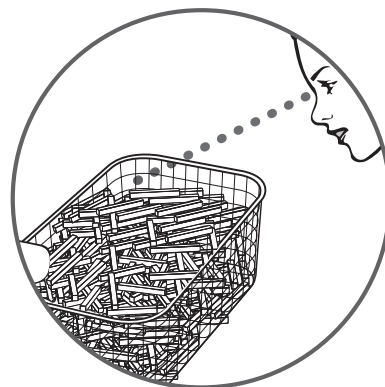
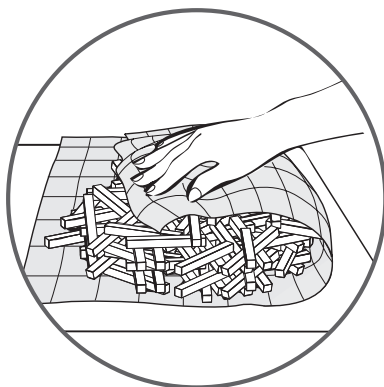



5

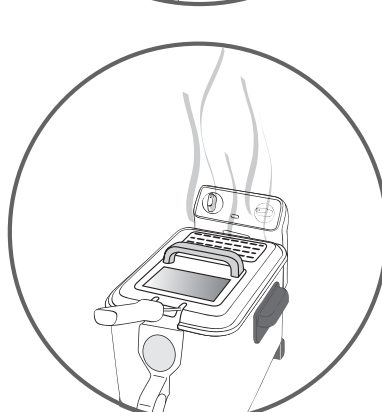
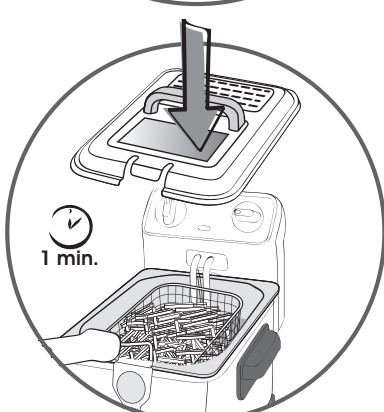
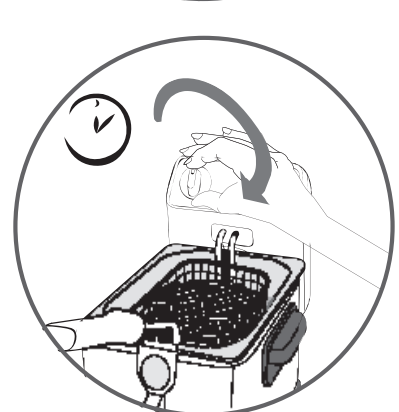
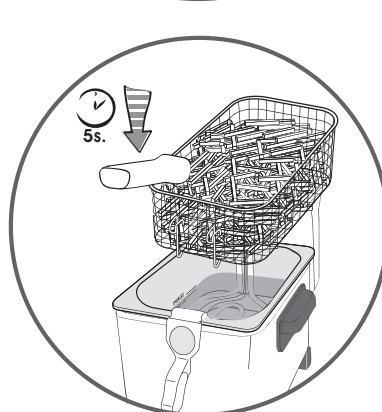
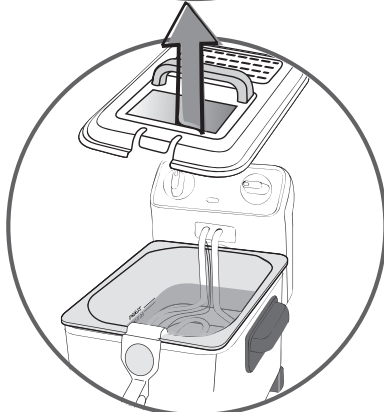
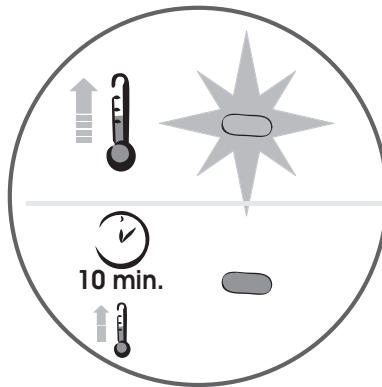
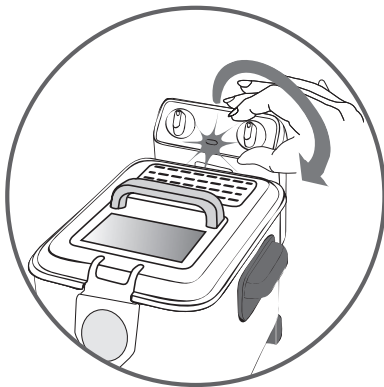
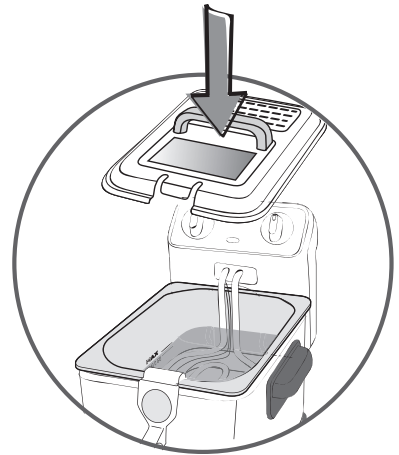
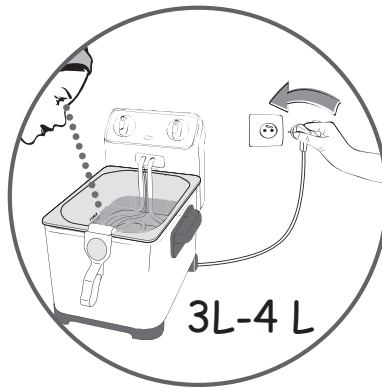

7

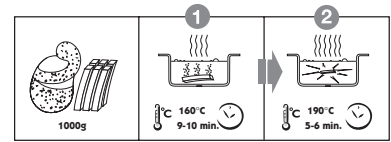

| | Nb | | °C | |
|--------------|-------|-------|---------|-----------|
| | | 1000g | ① 160°C | 7-8 min. |
| | | | ② 190°C | 5-6 min. |
| | | 600g | 170°C | 9-10 min. |
| | | 800g | 180°C | 9-10 min. |
| | | 800g | ① 160°C | 6-7 min. |
| | | | ② 190°C | 3-4 min. |
| | | 400g | 170°C | 8-9 min. |
| | | 700g | 180°C | 9-10 min. |
| | | 400g | 160°C | 6-8 min. |
| | 8-9 | | 170°C | 5-6 min. |
| * * * | | | °C | |
| | | 450g | 170°C | 7-8 min. |
| | | 900g | 190°C | 8-9 min. |
| | | 300g | 170°C | 6-7 min. |
| | | 600g | 190°C | 7-8 min. |
| | 12 | | 190°C | 6-7 min. |
| | | 1300g | 190°C | 7-8 min. |
| | | 1200g | 190°C | 7-8 min. |
| | 10-12 | | 190°C | 6-8 min. |



7

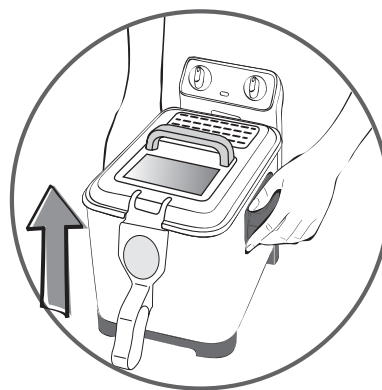
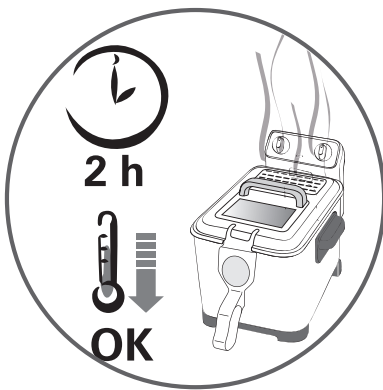
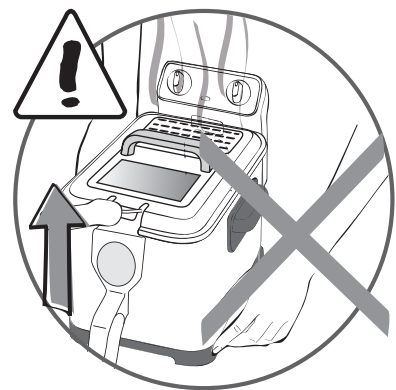
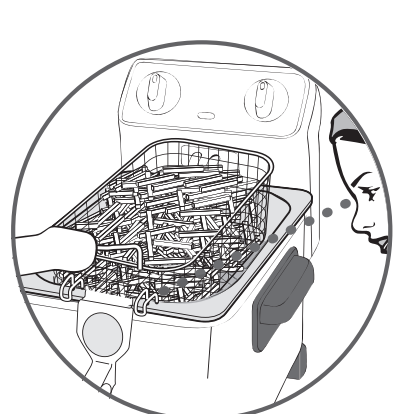
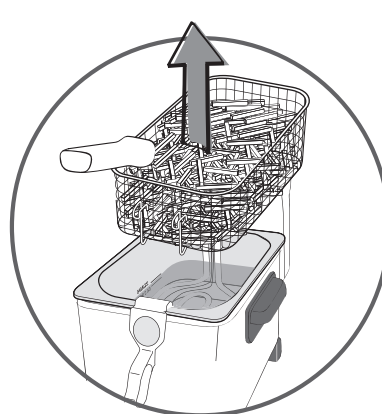
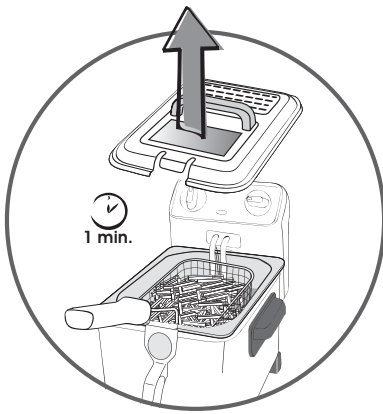

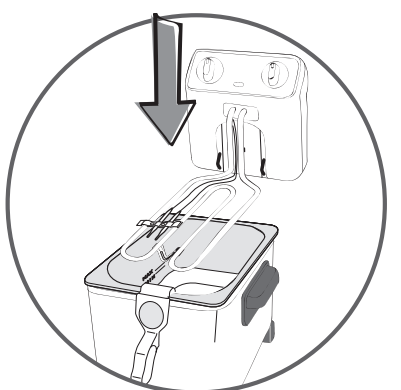
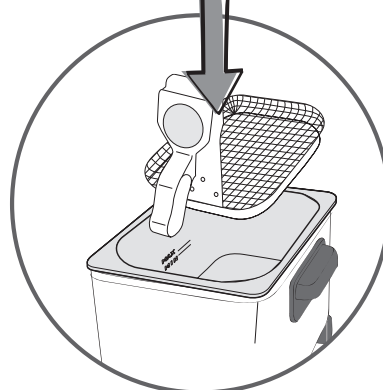
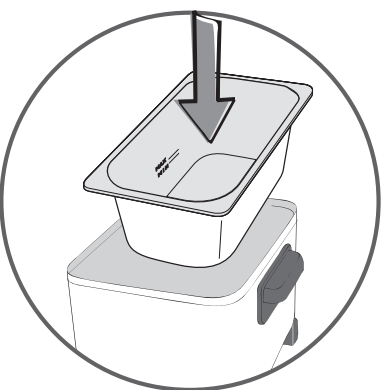
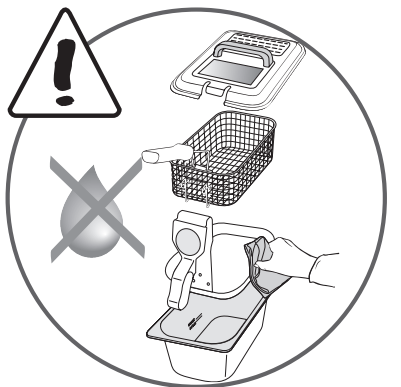
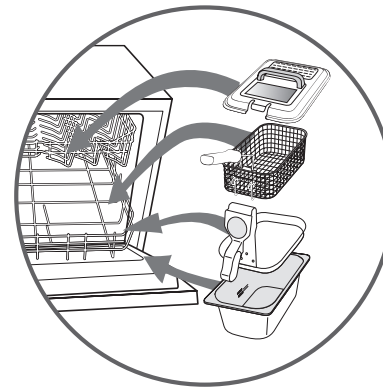
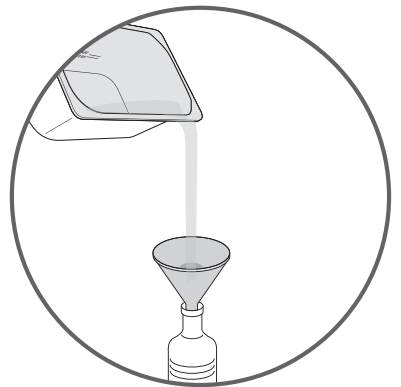
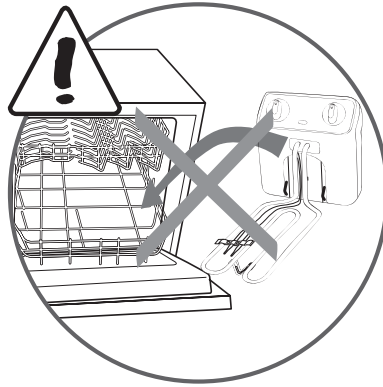
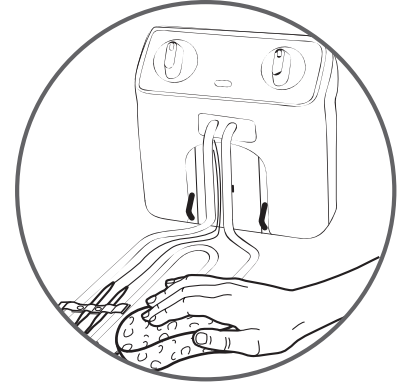
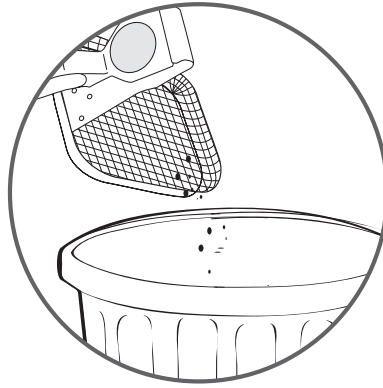
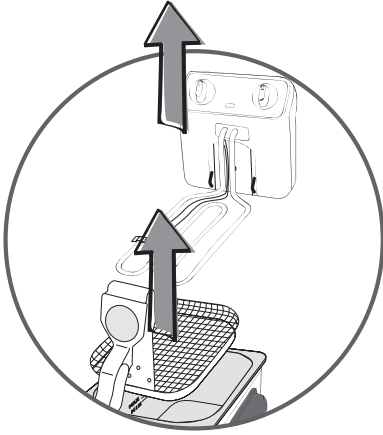
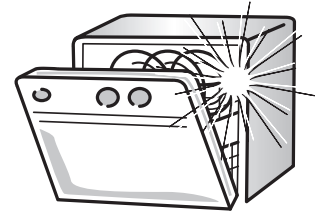

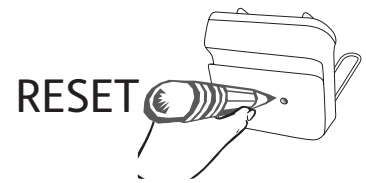
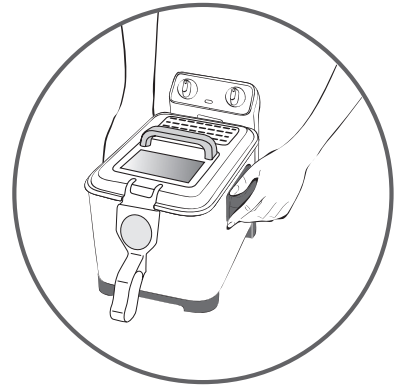
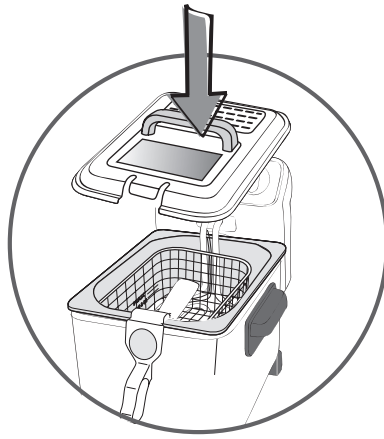
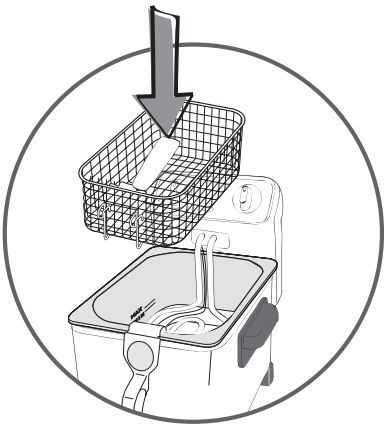

9

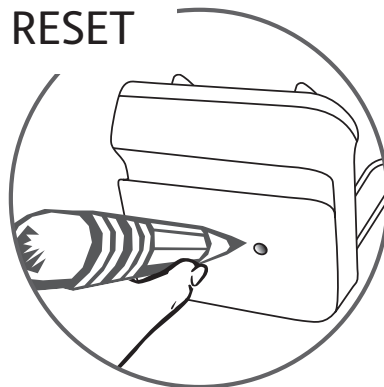
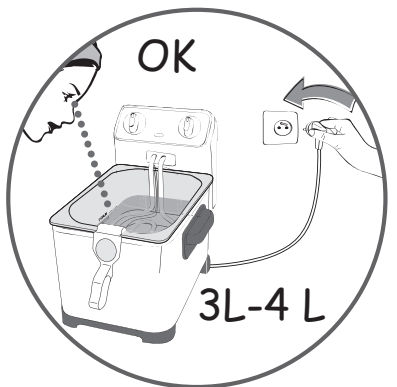
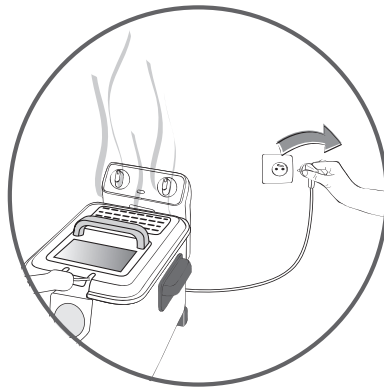
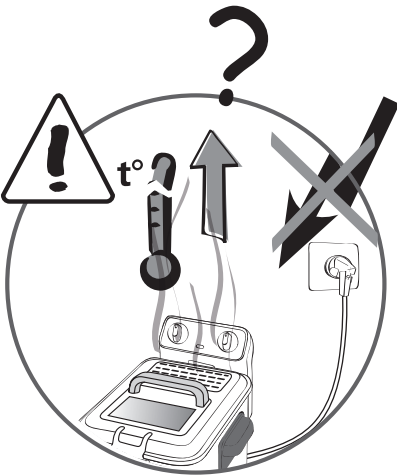

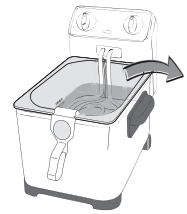

10

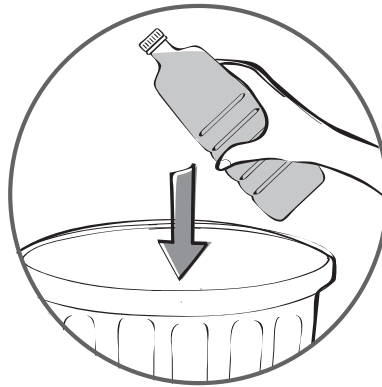
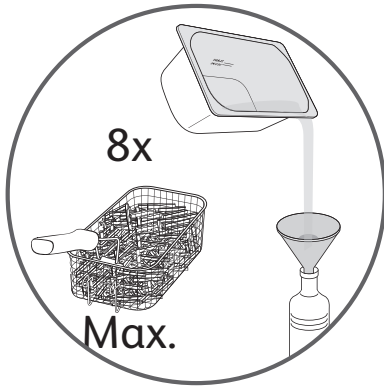

11

